

AMERICAN GARELLI SERVICE MANUAL

A guide to
servicing the
Garelli 49cc
moped engine—
prepared for use
by American Garelli
dealers and technicians.

TABLE OF CONTENTS

1. Specifications	1
2. Vehicle Identification	2
3. Pre-Delivery Servicing	3
4. Oil Injector	4
5. Maintenance Servicing	5
6. Decarbonization	6
7. Special Tools	7
8. Torque Specifications	7
9. Engine Removal	8
10. Engine Disassembly	11
11. Checks and Verifications	16
12. Engine Reassembly	17
13. Electrical/Ignition System	23
14. Carburetor	29
15. Trouble Shooting	30

1. SPECIFICATIONS

DIMENSIONS AND WEIGHT

Tire (front and rear)	2.25 x 16 in.
Weight (dry)	46 kg. (101 lbs.)
Overall Length	1.65 m (65 in.)
Overall Width	0.70 m (27.6 in.)
Overall Height	1.060 m (41.7 in.)
Wheel Base	1.10 m (43.3 in.)

LIQUID CAPACITIES

Gas Tank	3 liters (0.8 gals.)
Gearbox	400 cc (13.5 ozs.)

ENGINE

Type	2 cycle, single cylinder, air cooled, piston valve
Bore	40 mm
Stroke	39 mm
Displacement	49 cc
Weight (dry)	8.10 kg. (18 lbs.)

ELECTRICAL

Ignition System	C.E.V. Mechanical Point
Ignition Timing	1.3 mm B.T.D.C. 18 degrees B.T.D.C.
Spark Plug	0.5 mm (0.020 in.)
Head Lamp	Sealed beam, 6v, 18w
Tail/Stop Bulb	6v, 5/8w

2. VEHICLE IDENTIFICATION

The frame number can be found on the left side of the frame head.



The engine number can be found on the right side of the engine below the pedal shaft.

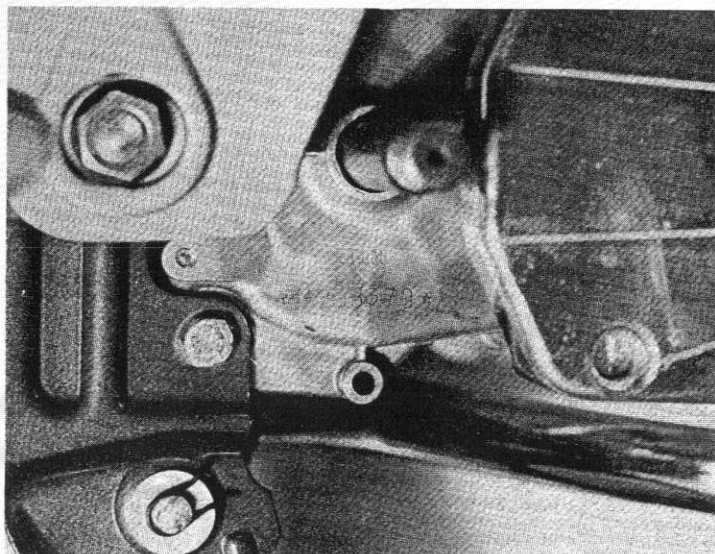

3. PRE-DELIVERY SERVICING

1. Install handlebars leaving expander bolt loose:
NOTE: The expander device may require slight lubrication if rusted.
2. Install engine stop switch on right side of handlebars:
NOTE: Twist handlebars to the right to install switch.
3. Install gas control throttle assembly on right side of handlebars, leaving control loose.
4. Install horn/light switch on left side of handlebars:
NOTE: Twist handlebars to the left to install switch.
5. Install clutch control lever assembly on left side of handlebars.
6. Set levers and switches in correct position and secure.
7. Adjust handlebars for correct position and tighten expander bolt.
CAUTION: Make sure at least 2½" of stem is in headset before securing expander bolt.
8. Install and secure seat.

9. Install taillight and corresponding wires:
NOTE: Blue wire to "S" terminal
Black wire to "G" terminal
Grey wire to "T" terminal
CAUTION: If these wires are not connected to the proper terminals engine failure will occur.

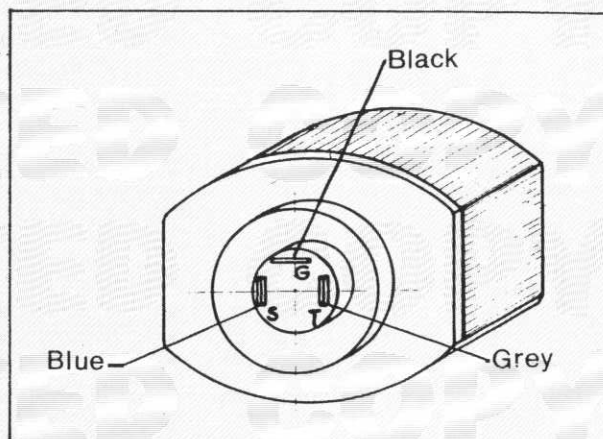

10. Install crankarms and pedals:
NOTE: Install crank with "D" mark on right side of bike.
11. Tighten reflector screw on both pedals:
NOTE: Certain models do not have these screws.
12. Tap both crankarm pins and tighten.
13. Check tire pressure:
NOTE: Front tire 18 psi—Rear tire 28 psi.
14. Check tightness of all bolts and screws:
NOTE: This is IMPORTANT, and special attention should be given to the following:

LOCATION	QUANTITY	SIZE
Wheel nuts	4	17 mm
Shock abs. nuts	4	17 mm
Swingarm nuts	2	19 mm
Motor mount nuts	3	13 mm
Muffler mount bolts	2	8 mm
Left side cover	6	screw
Carburettor mount	1	screw

15. Check chain tightness and rear wheel alignment.
16. Check all cable and control adjustments.
17. Check for correct amount of gear box oil:
NOTE: Oil should be level with oil level plug, located on the left side of engine. This is determined when oil shows by leaning bike about 10 degrees to the left side. If additional oil is needed, add 30 wt. non-detergent oil. The total amount of gear box oil is 13.5 ounces (400 cc).
18. For models with oil injector refer to oil injector (section 4). For models without oil injector pour gas/oil mixture in tank:
NOTE: Normally use 5 ounces of 2 cycle oil to 1 gallon of regular gasoline. If American Garelli oil is used, mix 3 ounces of oil to 1 gallon of regular gasoline. This mixture is used for break-in of engine only.
19. Check that spark plug gap is set at .020" (.5 mm).
20. Start engine and set carburetor idle adjustment on the left side of carburetor.
21. Test ride for general inspection—again checking all controls.
22. Adjust and check all lights.

4. OIL INJECTOR

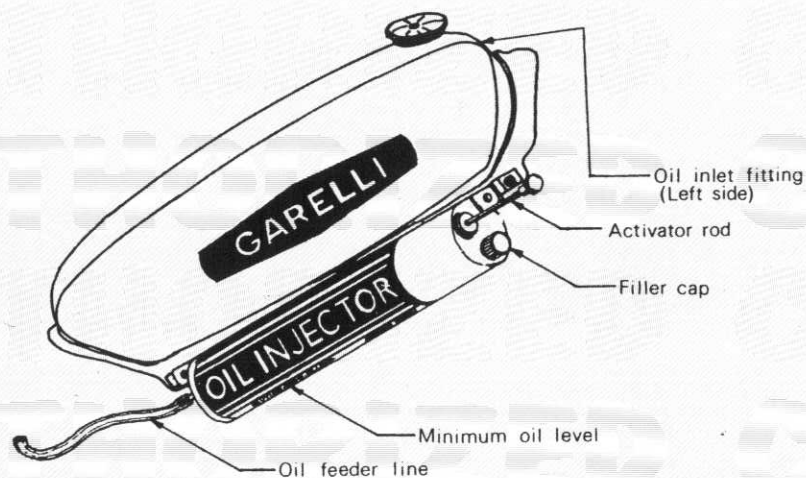

1. Fill the oil injector reservoir with the proper oil (Garelli 2 stroke engine lubricant or Golden Spectro).
Do not connect oil feeder line.
2. Place end of oil feeder line into empty oil bottle or can to catch any oil as feeder line is bled.
3. Slowly operate the oil injector activator rod until all air bubbles disappear from the feeder line.
4. Connect feeder line to fuel tank oil inlet fitting located on left front of fuel tank.
5. Recheck feeder line to insure that no air bubbles are present in the line.
6. Fill the fuel tank with regular leaded gas. Seven-tenths (.70) of a gallon will fill the tank to capacity leaving room for the oil. This amount is slightly less than 3/4 gallon or slightly less than 3 quarts.
7. Operate the activator rod through the complete cycle of pulls (one cycle is one complete pull and one complete push) to inject the required amount of oil into the fuel tank. Screw the knob down to secure.

5. MAINTENANCE SERVICING

Each Garelli moped should be checked at these intervals with a thorough inspection to include the following points.

Every 300 miles (500 Km)

- clean and gap spark plug.
- drain and replace gearbox oil—13.5 oz. (400 cc).
use SAE 30 non-detergent oil.

CAUTION: Do not use detergent oil.

- inspect tires.
- lubricate and adjust chain.
- clean carburetor.
- adjust contact points.
- adjust and lubricate all cables and controls.
- check the tightness of all screws and nuts.

Every 1200 miles (2000 Km)

- repeat the operations performed in the 300 mile check.
- clean carburetor (main jet, fuel filter screen, float chamber, etc.).
- remove, clean, and lubricate drive chain.

Every 2000 miles (3200 Km)

- repeat principle operations of 300 mile check.
- check clutch for wear.
- decarbonize engine (see Decarbonization) (section 6).
- check for brake wear.
- remove and oil all control cables.

6. DECARBONIZATION

Remove muffler:

Remove carbon from the mouth of exhaust pipe.

Check exhaust baffle for carbon deposit.

TOOLS: 5mm Allen wrench

Remove cylinder head:

Remove carbon.

TOOLS: 11 mm socket

Remove cylinder block:

Remove carbon from exhaust port; after scraping out carbon, taking care not to damage cylinder walls, smooth exhaust port with emery cloth.

Remove the piston rings and carefully scrape any carbon deposit from ring grooves.

Replace components following cylinder portion of engine re-assembly (section 12).

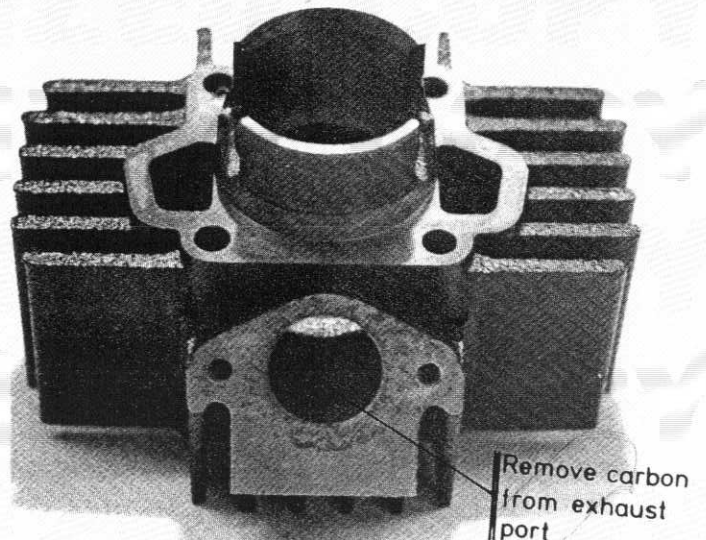

7. SPECIAL TOOLS

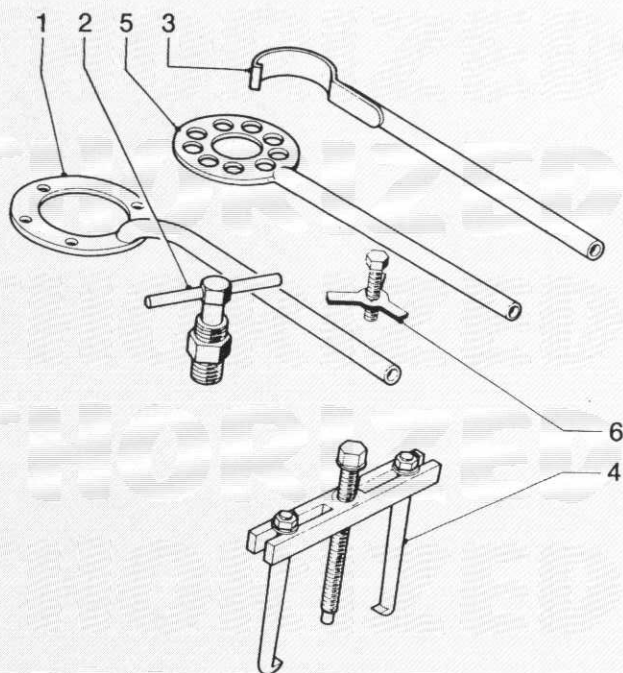

1. Holding Tool for Flywheel and Driven Gear
2. Flywheel Extractor Tool
3. Holding Tool for Primary Driving Sprocket
4. Driven Gear Extractor Tool
5. Holding Tool for Clutch Hub
6. Clutch Hub Extractor

Tool Number

1040
1050
1060
1070
1090
1100

8. TORQUE SPECIFICATIONS

		Torque kpm	Torque ft.-lb.
Cylinder Head Nut	11 mm	1.5 - 2.0	11 - 14
Flywheel Magneto Nut	12 mm	3.0 - 3.5	22 - 25
Clutch Nut	17 mm	3.0 - 3.5	22 - 25
Driving Gear Nut	17 mm	4.5 - 5.0	32 - 36
Chain Sprocket Nut	17 mm	6.0 - 6.5	43 - 47
Crankcase Screw	slothead	1.0	7
Left Side Cover Screw	slothead	1.0	7
Flywheel Side Cover Screw	slothead	0.2	1.5

9. ENGINE REMOVAL

Remove rubber mat and top cover held by 4 bolts.

TOOLS: 8mm socket

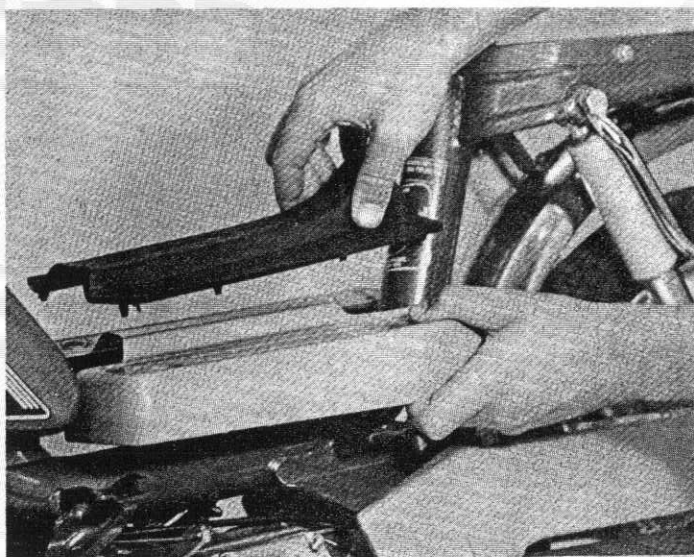

Disconnect the clutch cable.

TOOLS: Screwdriver or needlenose pliers,
17mm open end wrench

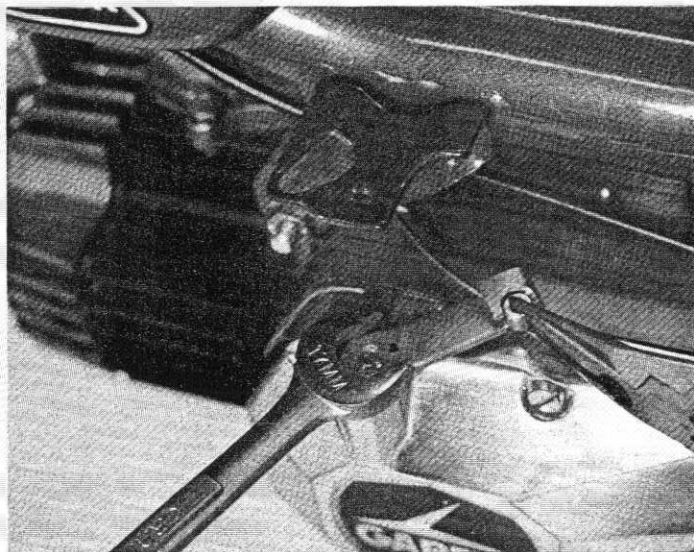

Remove the 2 exhaust manifold bolts.

TOOLS: 5mm Allen wrench

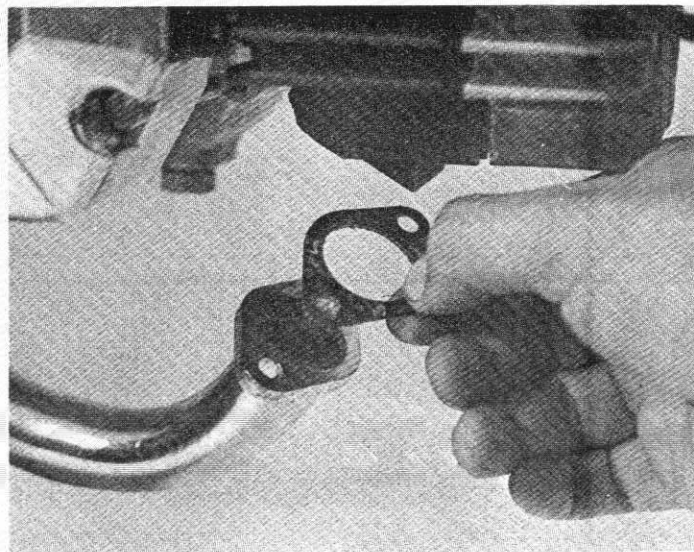

9. ENGINE REMOVAL

Disconnect the blue, yellow and black engine wires from the terminal block.

Disconnect the spark plug wire.

TOOLS: Small blade screwdriver

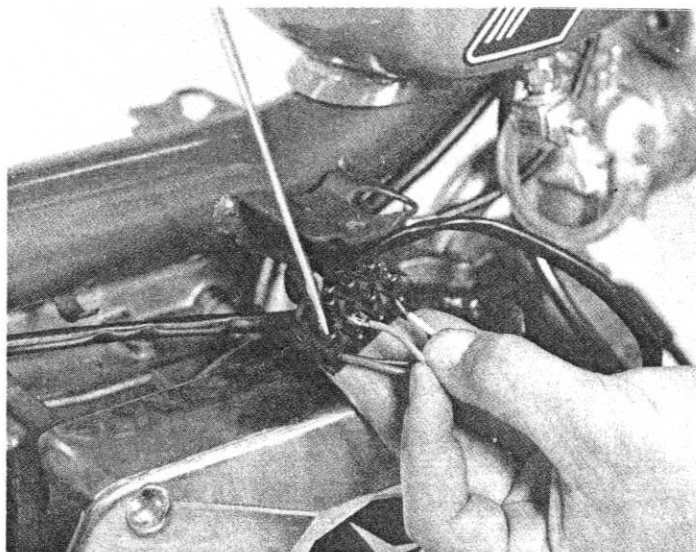

Remove carburetor by loosening the clamp screw and sliding off manifold.

TOOLS: Screwdriver

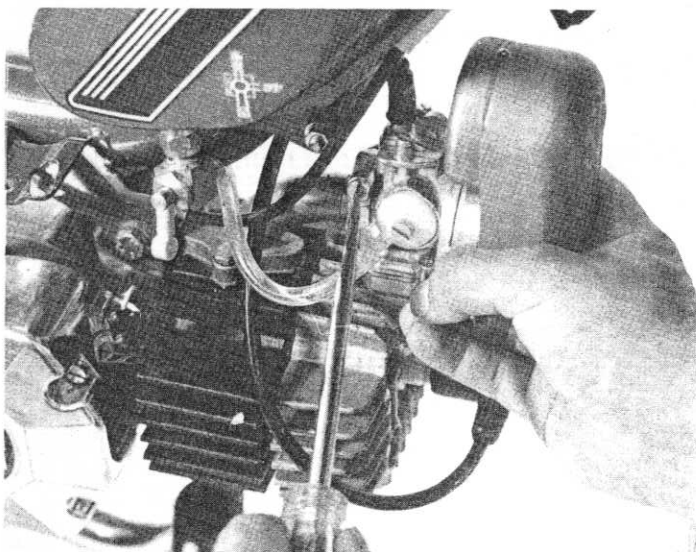

Remove the right chain guard by removing rear shock absorber bolt and the swingarm nut and washer.

TOOLS: 17mm open end wrench, 17mm socket, 19mm socket

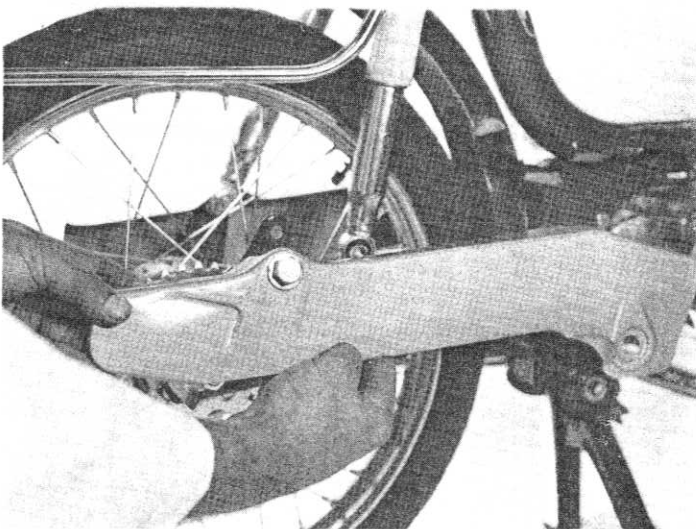

9. ENGINE REMOVAL

Break chain by removing master link.

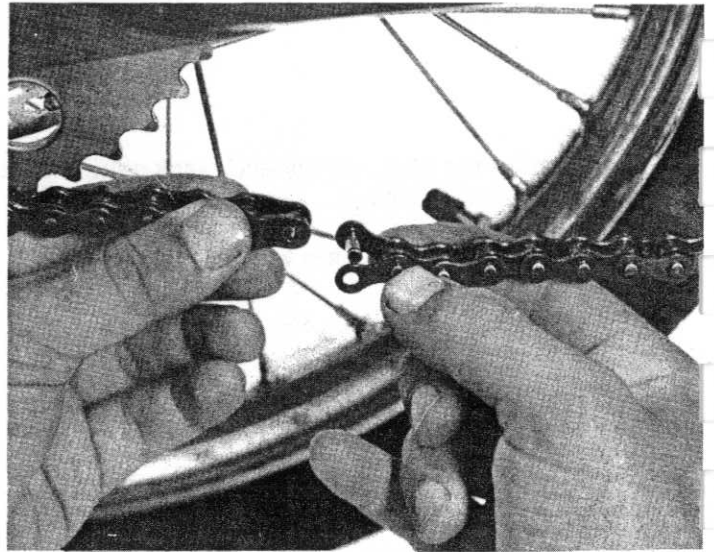

Remove the 2 rear and one front engine mounting bolts.

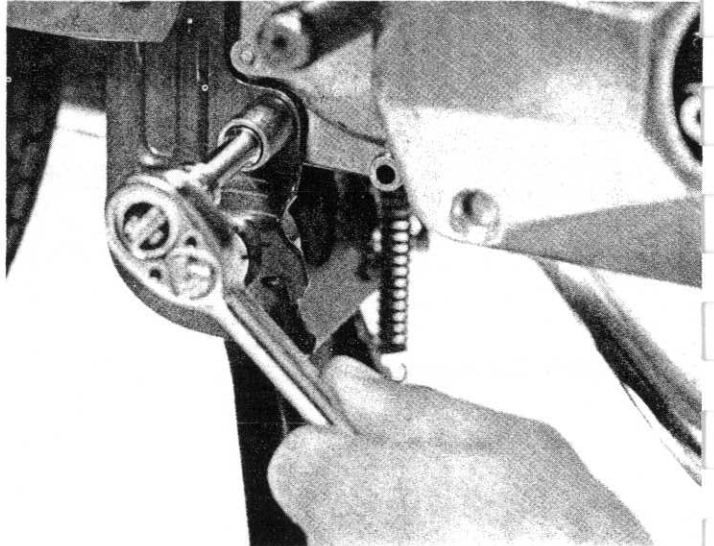

TOOLS: 13mm open end wrench, 13mm socket

Drop engine forward and down to remove.

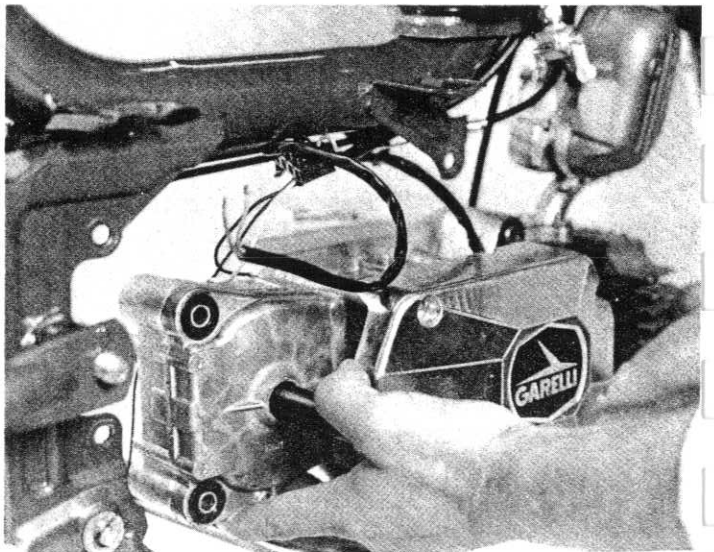

10. ENGINE DISASSEMBLY

After removing the spark plug, carburetor and pedals, for which no special tools or procedures are required, proceed as follows to dismantle the engine.

After removing the right side cover, remove the flywheel retaining nut and spring washer using special tool #1040 to hold the flywheel.

CAUTION: Do not scratch the coils with tool.

TOOLS: Special tool #1040, 12mm socket

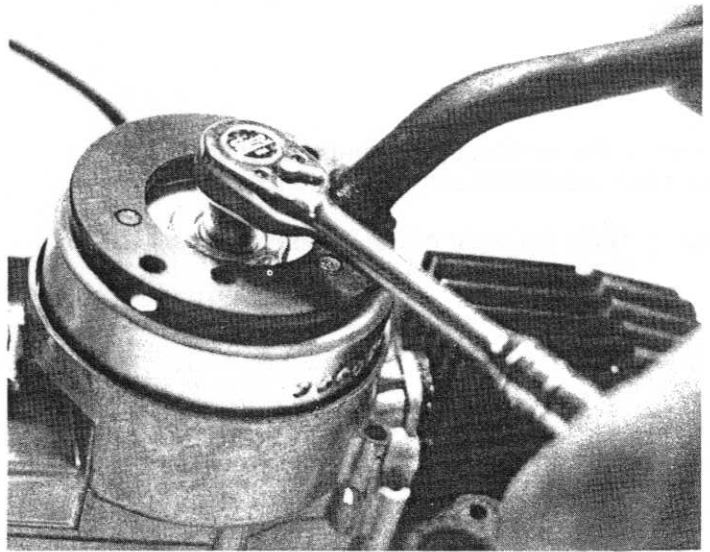

Screw the flywheel extractor into the threads of the flywheel, then turn the extractor center bolt in a clockwise direction to pull the flywheel off the taper. Remove the Woodruff key from the crankshaft.

CAUTION: Make certain that the external thread of the extractor is screwed fully into the flywheel.

TOOLS: Special tool #1050 (flywheel extractor), 14mm open end wrench, adjustable wrench

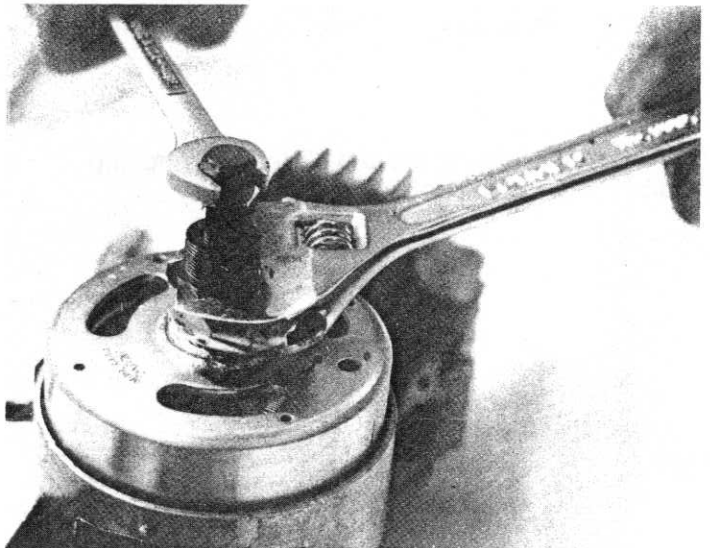

Make a scribe mark (s) across the bottom of the stator plate and the crankcase boss in order to facilitate re-timing on assembly. Remove the 2 screws (v) holding the stator plate to the crankcase. Lift the stator assembly from the engine.

TOOLS: Screwdriver

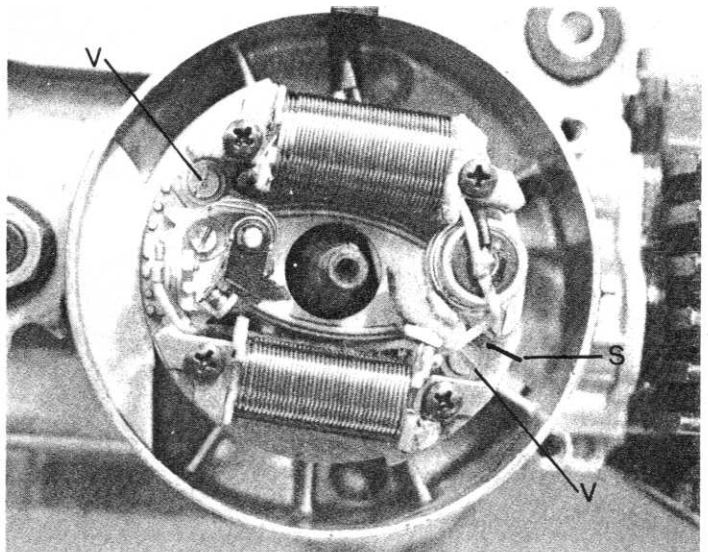

10. ENGINE DISASSEMBLY

Remove the nut from the countershaft sprocket, then pull the sprocket from the shaft.

NOTE: Note the order of the 2 spline washers and the spring washer.

TOOLS: Special tool #1060, 17mm wrench

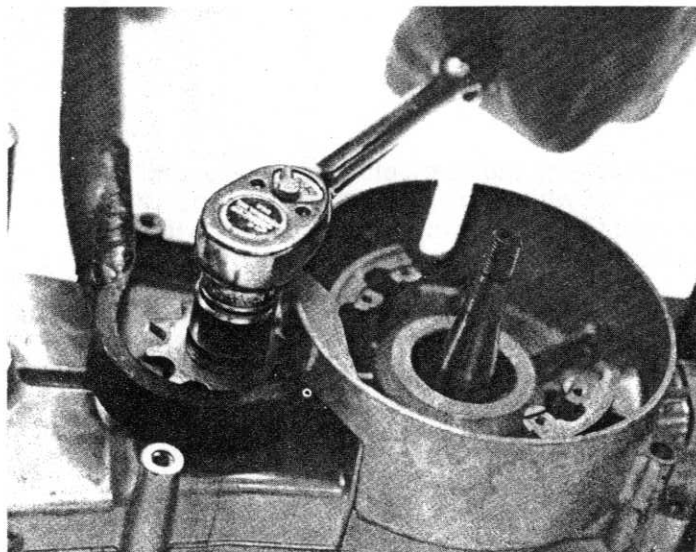

Drain oil from the gearbox and clutch by removing the drain plug on the bottom of the engine.

TOOLS: 17mm wrench

Remove the left sidecover and its' gasket.

TOOLS: Screwdriver

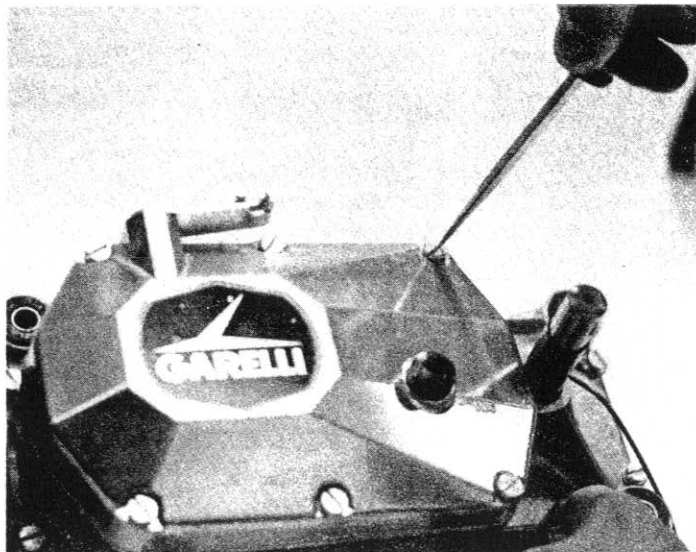

10. ENGINE DISASSEMBLY

After removing the circlip, the pressure plate and the spring from the clutch assembly, remove the nut and washer.

TOOLS: Special tool #1090, 17mm socket, circlip pliers

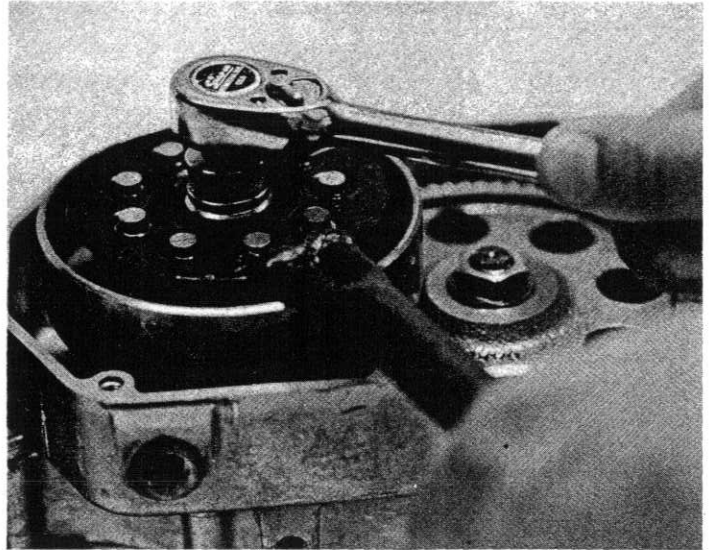

Slide the clutch hub, spline washer, and clutch housing from the crankshaft.

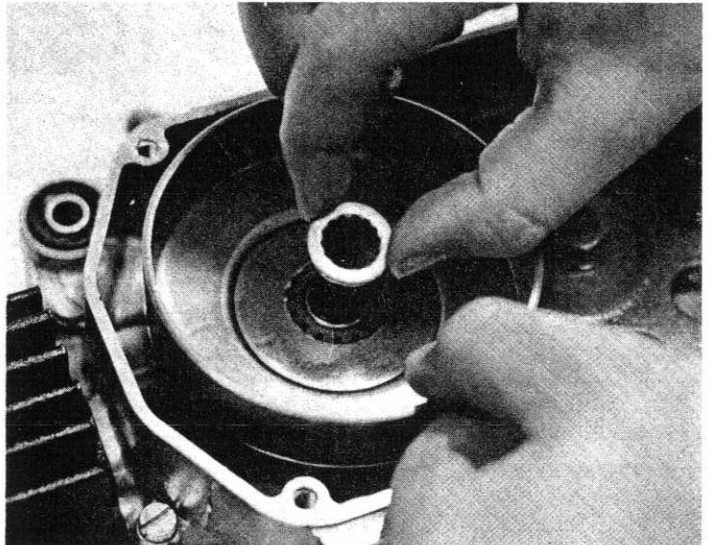

Arrange the screws in tool #1040 to fit the driving gear. Use this tool to hold the gear while unscrewing the nut. Remove the spring washer.

TOOLS: Special tool #1040, 17mm socket

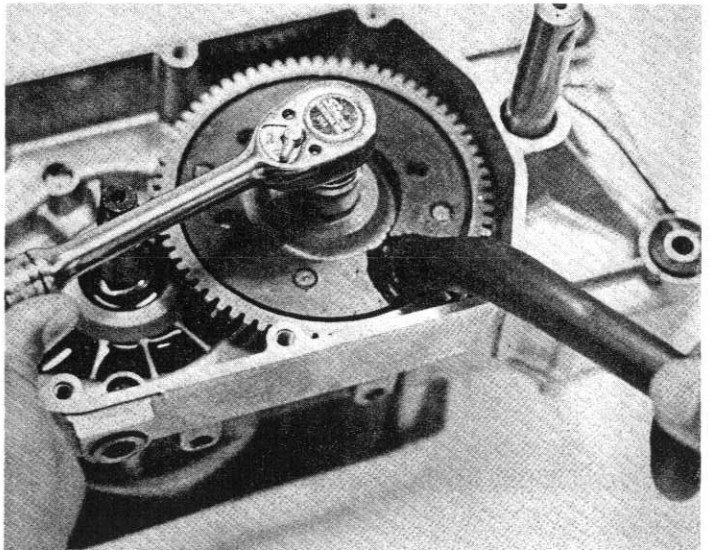

10. ENGINE DISASSEMBLY

Use extractor tool #1070 to remove the driving gear.

NOTE: This gear is on a tapered shaft, therefore, it will have a tendency to "snap" off. If any difficulty is encountered, a rubber mallet may be used to lightly tap around the edge of the driving gear while pressure is being exerted by the puller.

TOOLS: Special tool #1070, 19mm wrench

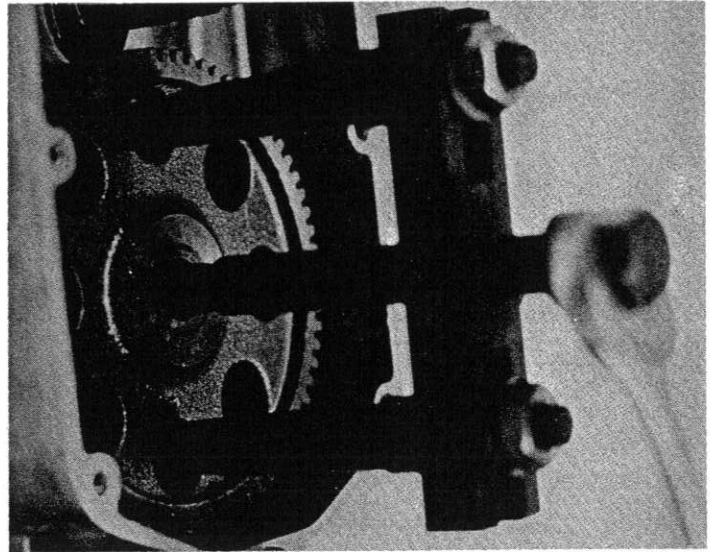

Remove the 4 nuts holding the cylinder head. Lift the head and cylinder over the 4 studs and remove the cylinder base gasket.

NOTE: If the cylinder is stuck to the crankcase, a mallet may be used to lightly tap around the cylinder to break it loose.

TOOLS: 11mm socket

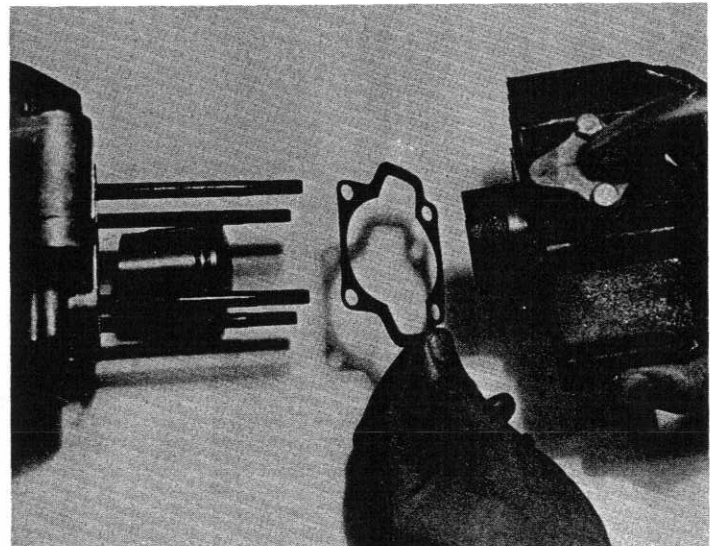

Remove the 2 circlips from the piston.

TOOLS: Needlenose or circlip pliers

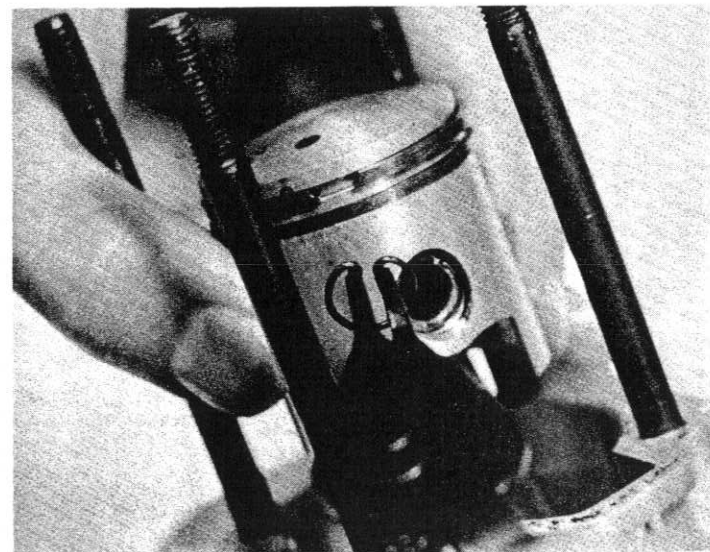

10. ENGINE DISASSEMBLY

Remove the piston gudgeon pin, the piston, and the needle bearing.

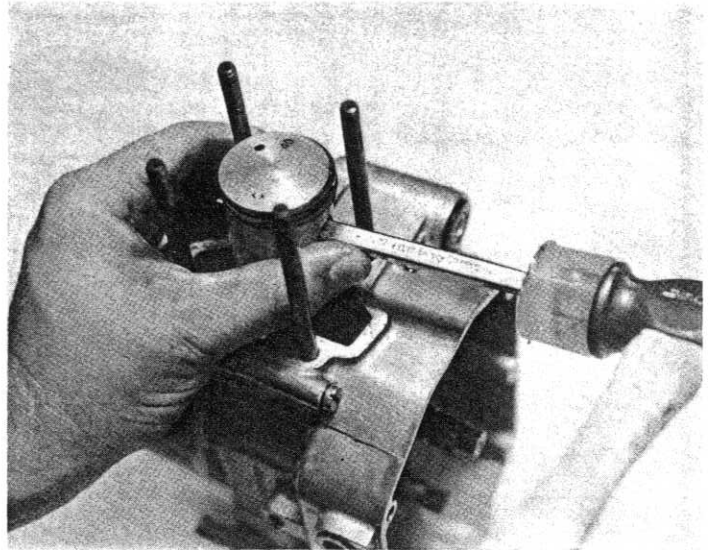

TOOLS: Gudgeon pin extractor, mallet

Remove the plastic protectors from the pedal shaft.

Remove the 10 crankcase screws from the right hand crankcase.

Strike the ends of the crankshaft (A), the primary shaft (B), and the pedal shaft (C) alternately with a mallet until the two halves of the crankcase separate.

TOOLS: Screwdriver, mallet

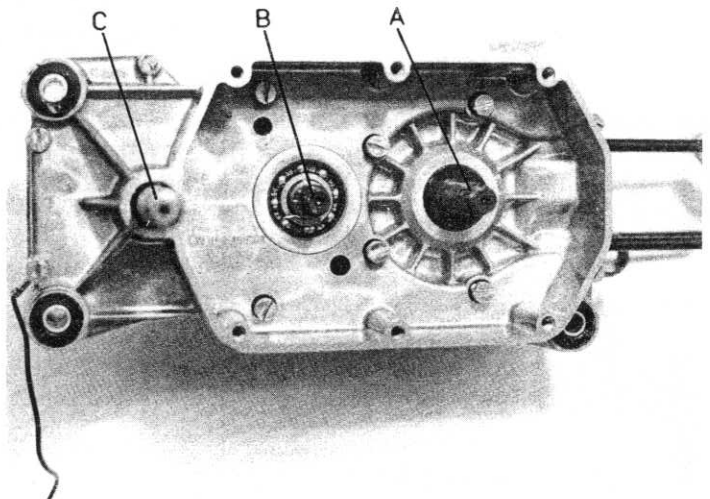

The gearbox components and crankshaft will slide out, or may be tapped out. The pedal shaft (C) and the primary shaft (B) are connected by an endless chain so both shafts will have to be slid out together.

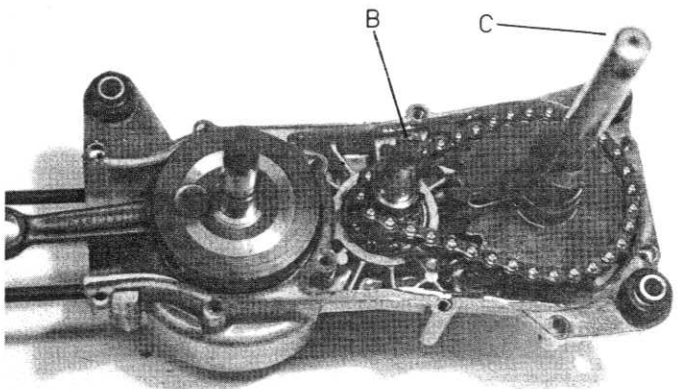

TOOLS: Mallet

11. CHECKS & VERIFICATIONS

Piston to cylinder clearance
Minimum - .0016" (.04mm)

Piston to cylinder clearance
Minimum - .0016" (.04mm)
Maximum - .002" (.05mm)
Limit - .004" (.1mm)

Piston ring end gap
Minimum - .012" (.3mm)
Maximum - .039" (.1mm)

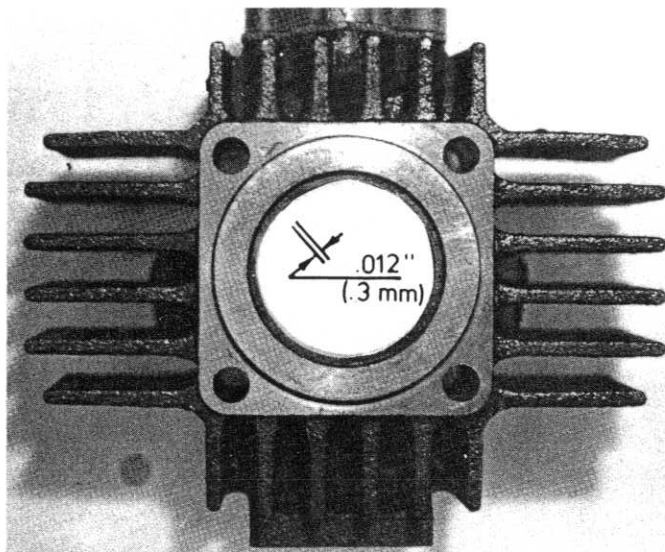

All Garelli cylinders have a dot of paint at the base of the intake port. The color of the dot of paint on the top of the piston should be the same as the color dot on the cylinder.

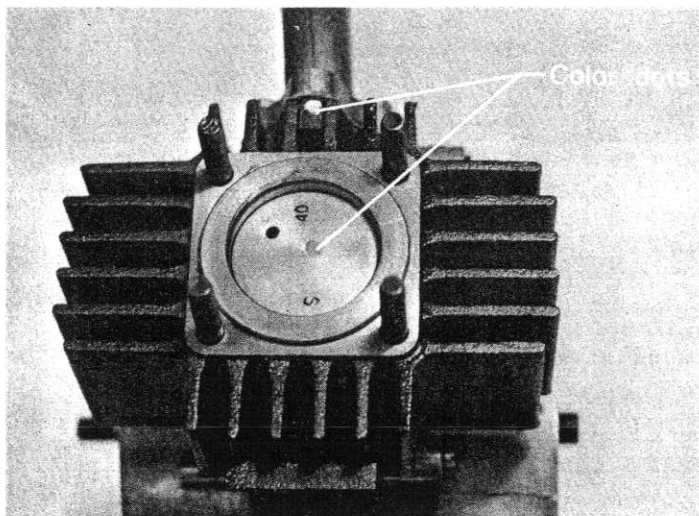

12. ENGINE REASSEMBLY

Insert the crankshaft (A) into the right hand crankcase.

CAUTION: Make certain that the tapered end of the crankshaft is toward the flywheel side.

Fit the primary shaft (B) along with the pedal shaft with the chain and the starting assembly, taking care that the spring (D) fits in its seat.

CAUTION: Make certain that the spring (D) remains in the seat.

TOOLS: Mallet

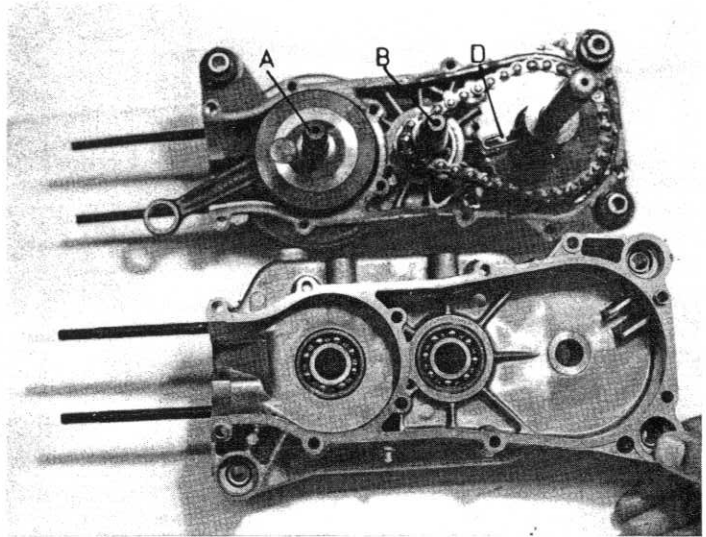

Join the left crankcase with the right one, acting as follows:

- A. Make sure that the faces of the cases are clean and free from burrs and that the dowels are in position.
- B. Slightly grease a new gasket on both sides, which is to be inserted between the two crankcase halves.
- C. Press the two crankcases by hand and then lightly tap them together with a mallet.
- D. Insert the 6 short screws in the inner holes and the 4 longer screws in the outer holes. Slowly tighten the screws in the order indicated in the illustration.
- E. Check that the crankshaft, the primary shaft and the pedal shaft turn freely.

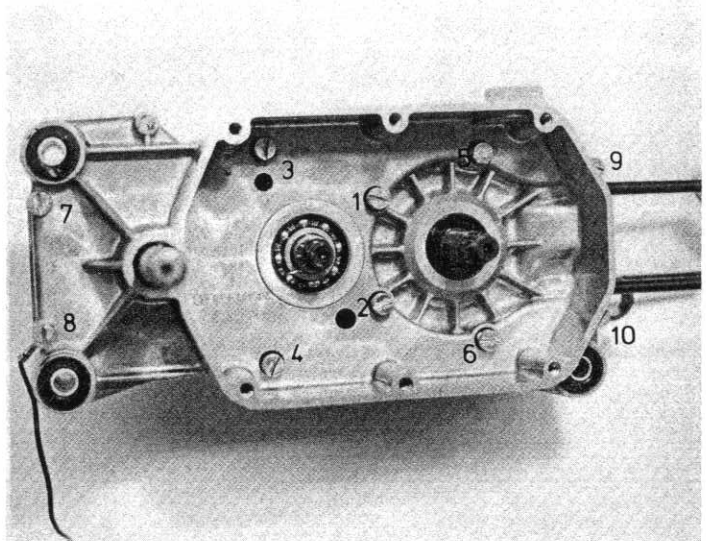

Insert needlebearing and gudgeon pin in crankshaft and refit piston, making certain that the "S" on the piston is toward the exhaust port or downward.

CAUTION: The piston circlips should be properly inserted and fully expanded in their grooves.

TOOLS: Circlip pliers or needlenose pliers

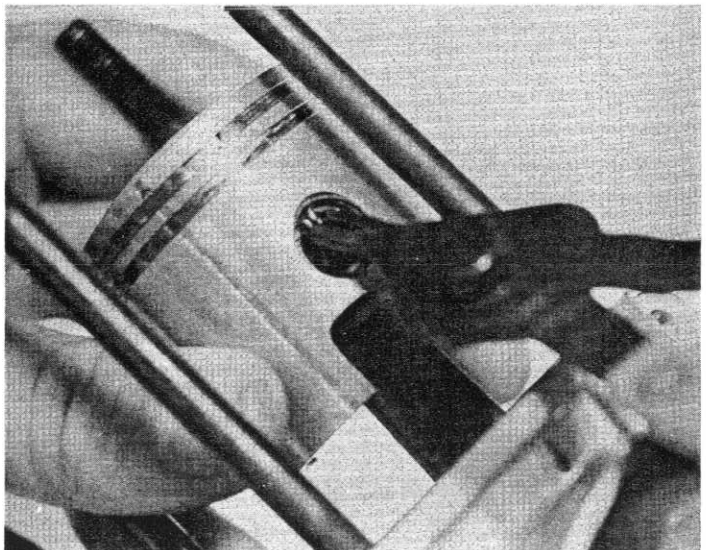

12. ENGINE REASSEMBLY

Check that the crankcase upper face and the cylinder base are clean and free from burrs. Lightly grease a new gasket on both sides and lay it on the crankcase face. Oil the cylinder bore and the piston skirt. Lower the cylinder onto the piston with fingers compressing the rings into the bore.

CAUTION: Make sure the ends of the piston rings are properly fitted in position against the pegs of the ring grooves.

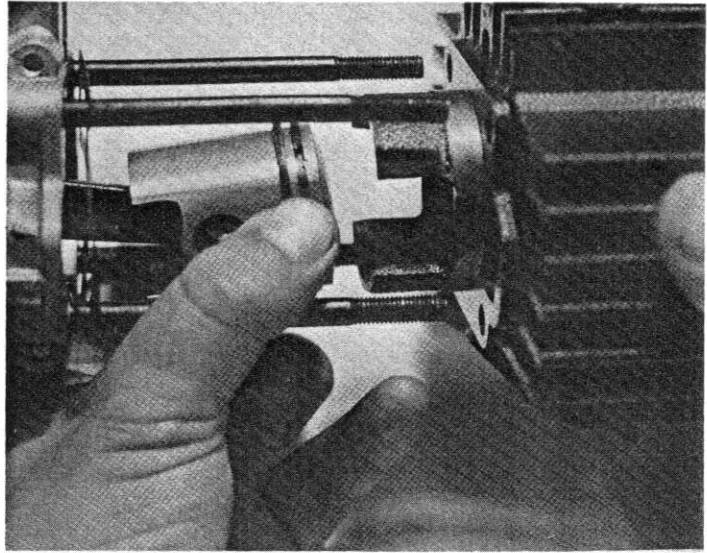

Check that the top of the cylinder and the face of the head are clean and undamaged. Fit the head over the studs and place the 4 washers and nuts on the studs. Tighten the nuts gradually in a cross pattern. The final torque should be 12 ft./lbs. (1.6 kgm.).

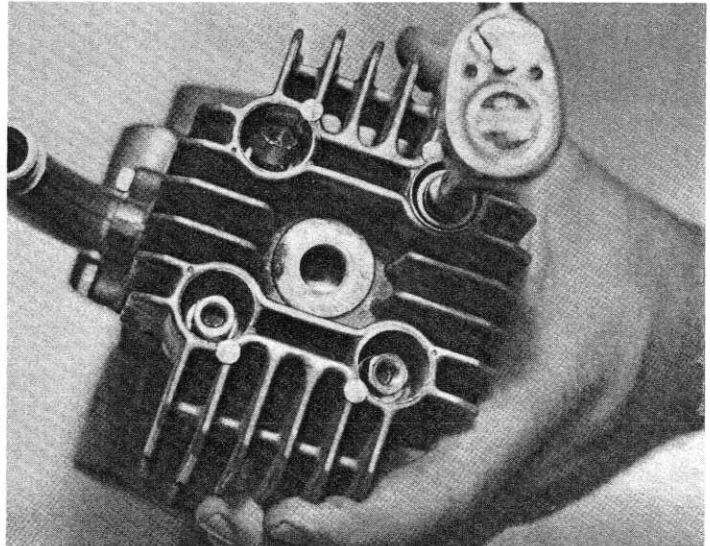

TOOLS: 11mm socket, torque wrench

Refit the driving gear to the tapered shaft placing the washer and nut. Tighten the nut to 35 ft./lbs. (5 kgm.).

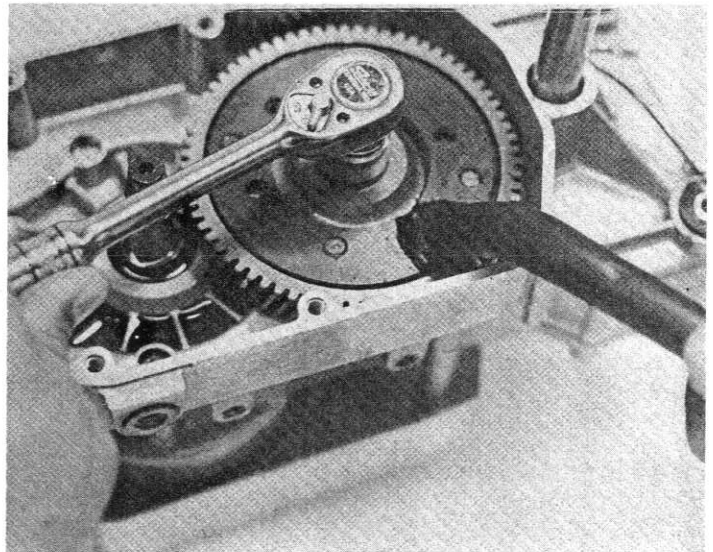

TOOLS: Special tool #1040, torque wrench, 17mm socket

12. ENGINE REASSEMBLY

Center punch the shaft to lock the nut into place.

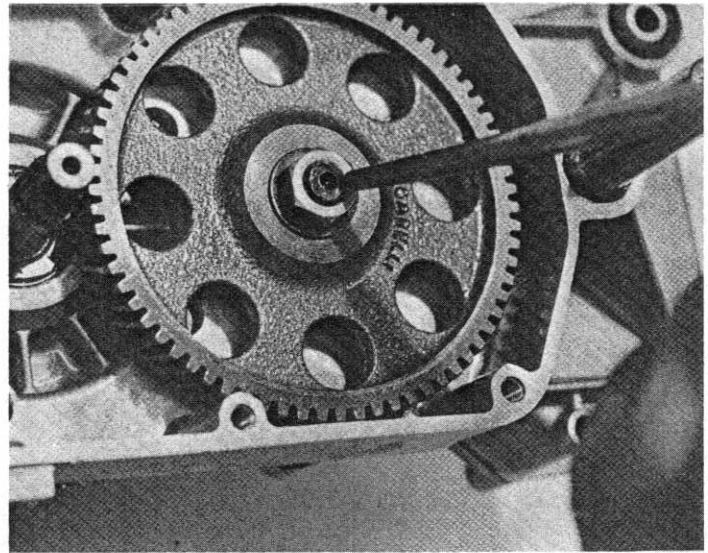

TOOLS: Hammer, center punch

Place washer and spring washer on the crankshaft. Slide the clutch housing and spline washer onto the crankshaft.

CAUTION: The flat side of the spline washer should face toward the center of the engine.

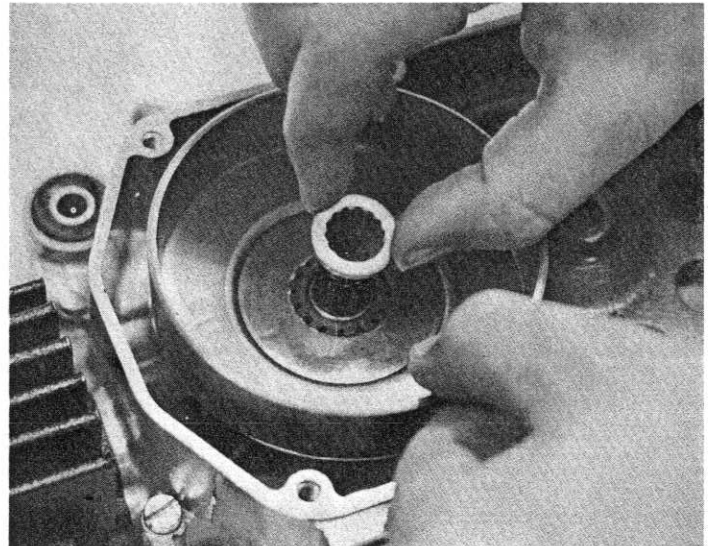

Mount the clutch hub with the spring washer and nut. Tighten to 23 ft./lbs. (3 kgm.).

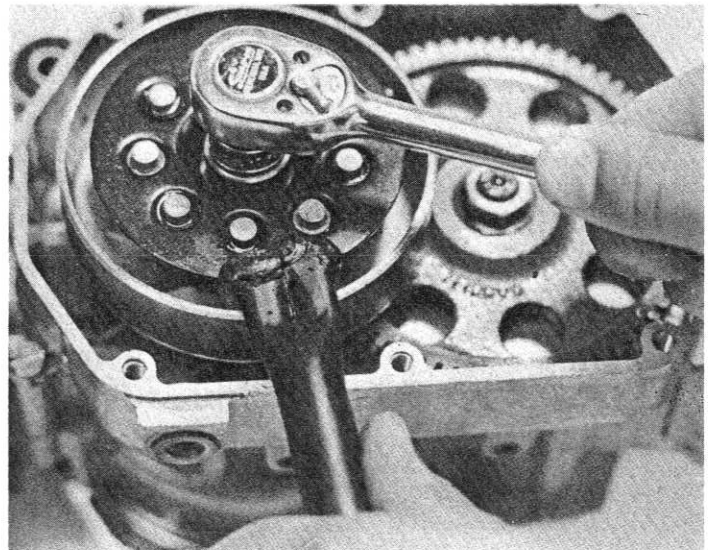

TOOLS: Special tool #1090, 17mm socket, torque wrench

12. ENGINE REASSEMBLY

Check to see that the clutch housing turns independently of the clutch hub and crankshaft. The axial play of the clutch assembly should be as little as possible, taking care, however, that it will still turn free from the crankshaft. To reduce possible excessive play, the spline washer (part #2350) may be fitted with the chamfer side towards the engine center line.

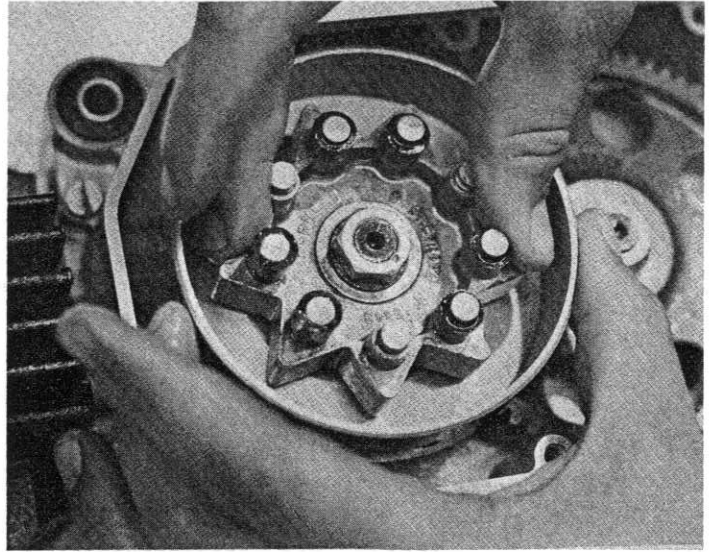

Insert the spring over the clutch hub nut.

NOTE: The spring will fit only in one direction.

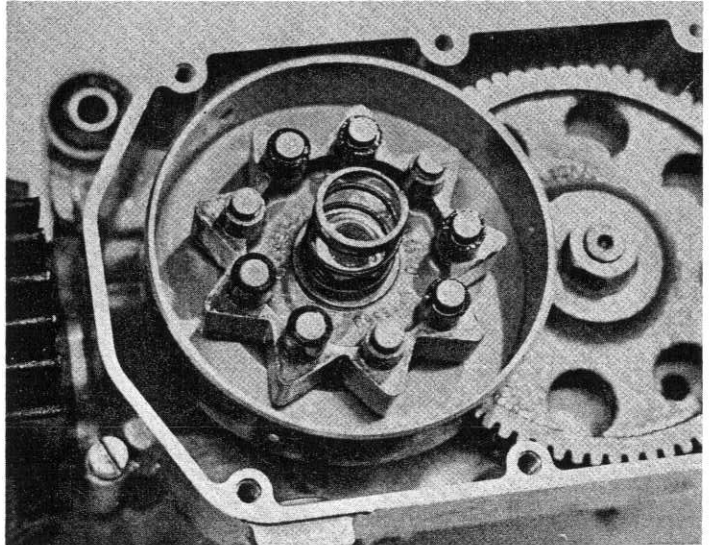

Place clutch body and pressure plate over clutch hub. Insert clutch circlip while maintaining pressure on the pressure plate.

CAUTION: Tap the circlip to make certain that it is well seated.

TOOLS: Needlenose or circlip pliers

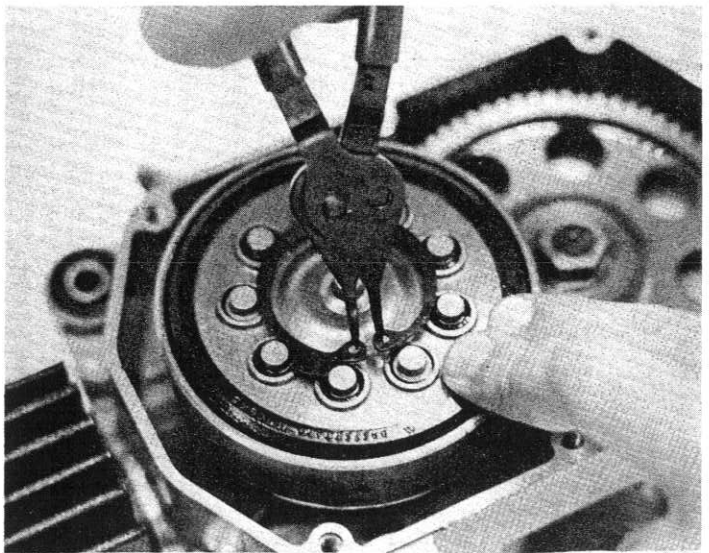

12. ENGINE REASSEMBLY

Check that the surfaces of the left side cover and the crankcase are clean. Lightly grease both sides of the cover gasket and insert.

CAUTION: The gasket has an indentation to clear the pedal shaft.

Screw the side cover down.

TOOLS: Screwdriver

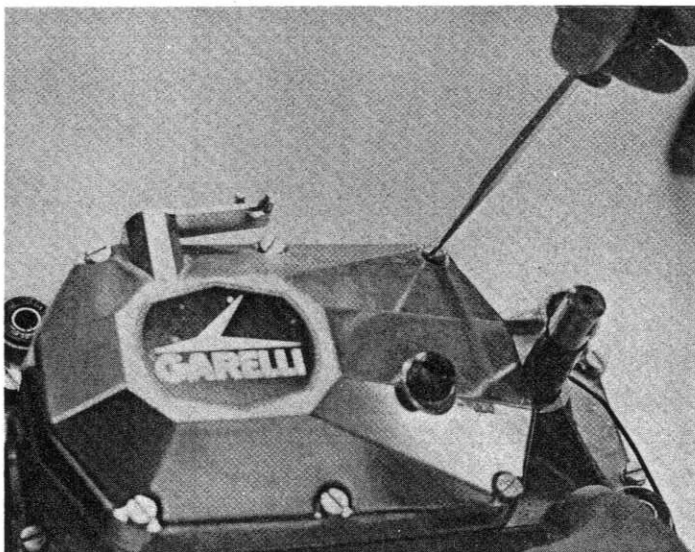

Fit the Woodruff key in position on the tapered end of the crankshaft.

NOTE: A small amount of grease may be used to hold the Woodruff key in place.

Fit the stator plate so that the scribed mark (S) previously made is in line, and lightly tighten the 2 mounting screws.

Slip the flywheel onto the crankshaft taking care that the Woodruff key is still correctly seated. The spring washer and flywheel nut may now be inserted and tightened to 12 ft./lbs. (3 kgm.).

TOOLS: Special tool #1040, 12mm socket, torque wrench

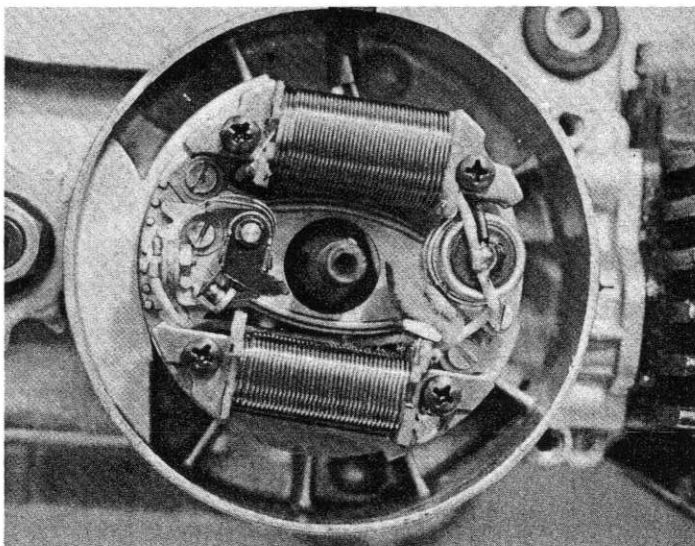

Rotate the flywheel until the points gap is the widest position. At this position check the gap with a feeler gauge, resetting if necessary to .014" — .018" (.35 - .45mm).

NOTE: For more detail see Electrical System (section 13).

12. ENGINE REASSEMBLY

To check the timing rotate the flywheel in the counterclockwise direction until the contact points just begin to open. At this instant the timing marks on the flywheel and crankcase should line up. If they do not, the stator plate may be rotated by loosening the 2 fastening screws. This can be done through the windows of the flywheel so that it is not necessary to remove the flywheel. After obtaining correct timing retighten the 2 fastening screws.

Replace the right side cover.

13. ELECTRICAL/IGNITION SYSTEM

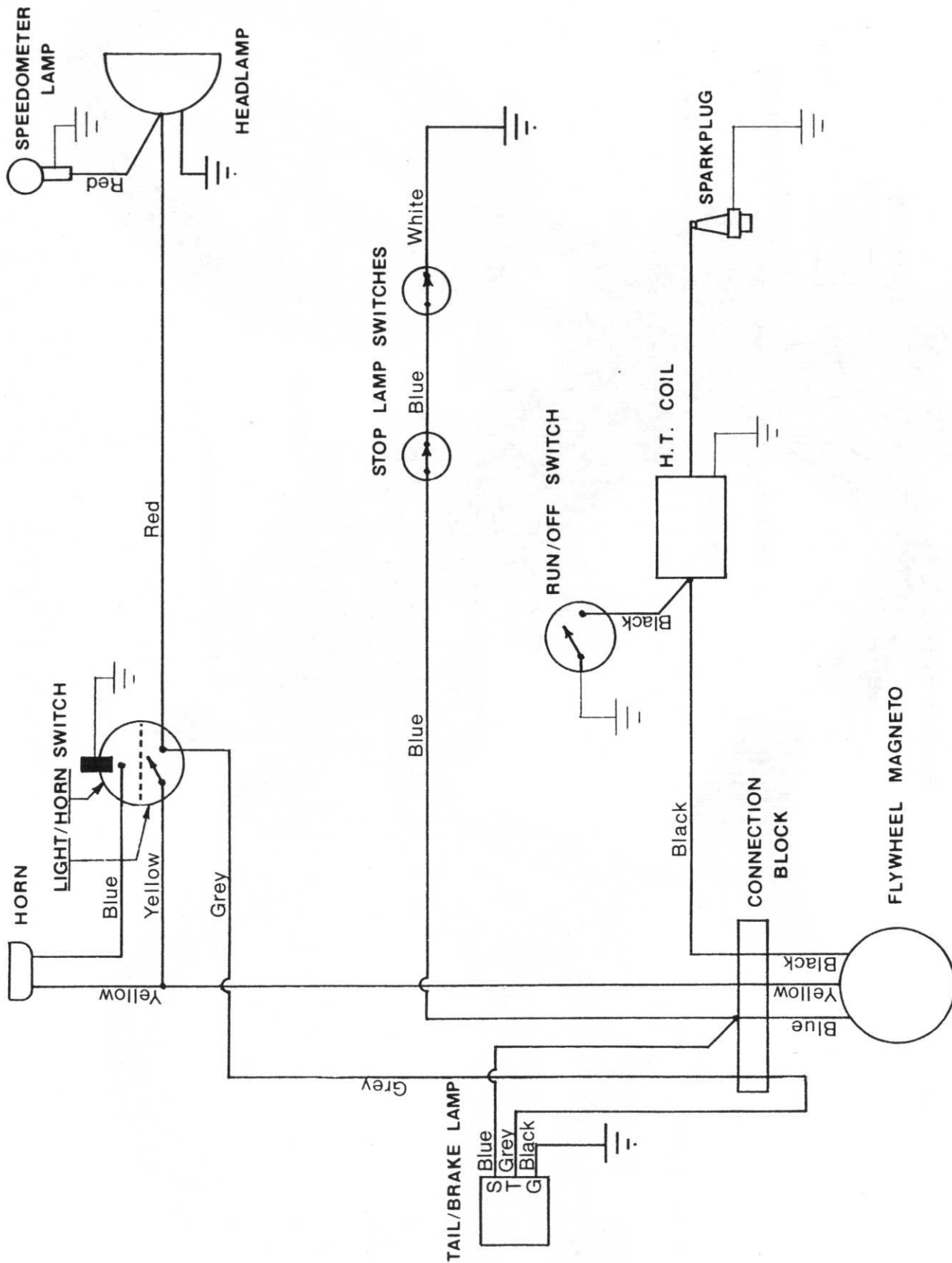

13. ELECTRICAL/IGNITION SYSTEM

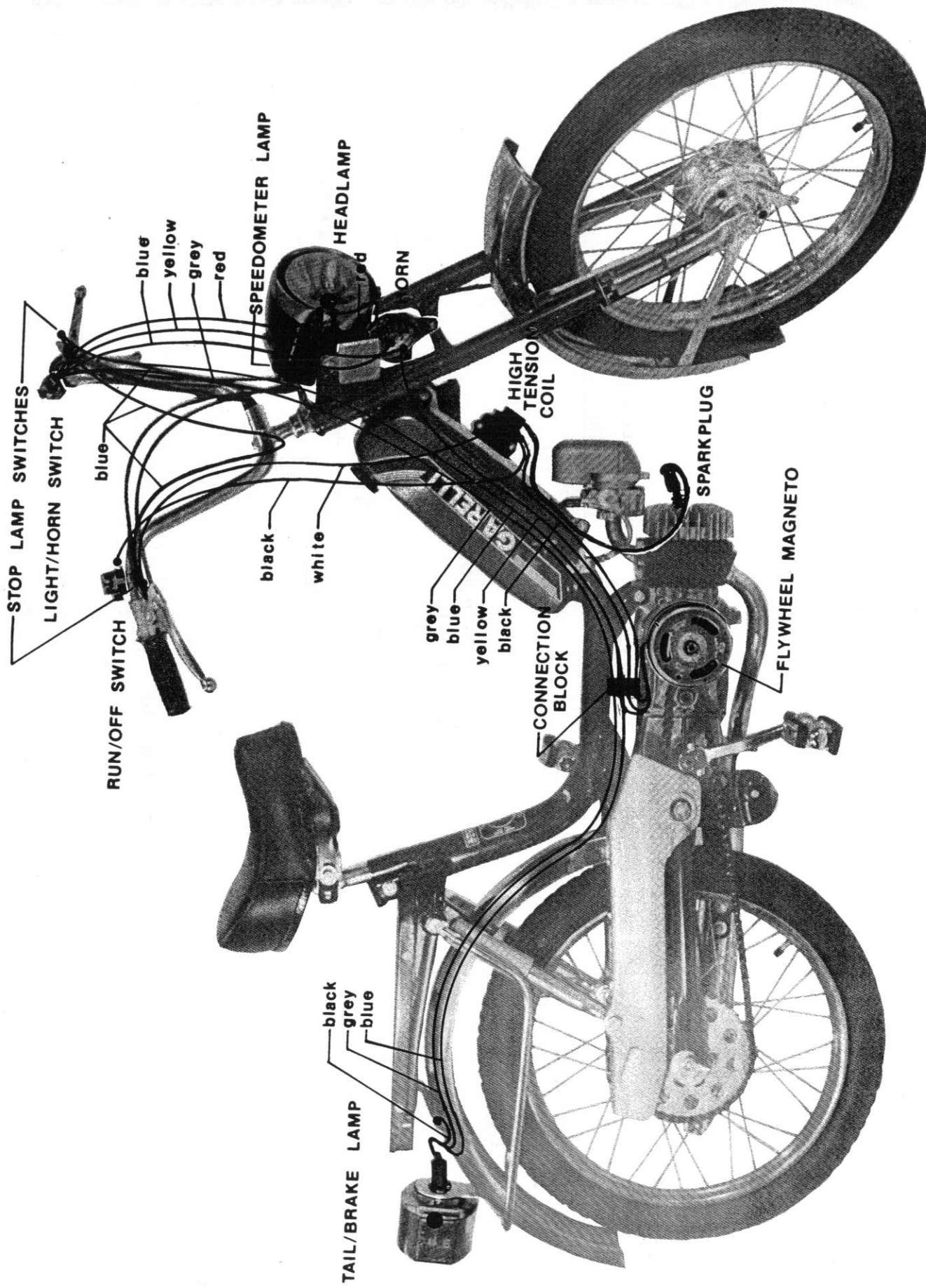

13. ELECTRICAL/IGNITION SYSTEM

FLYWHEEL MAGNETO SYSTEM

1. Stator plate assembly
 - A. low tension (L.T.) coil
 - B. lighting coil
 - C. contact points
 - D. adjusting screw
 - E. condenser
2. High tension (H.T.) coil
3. Flywheel

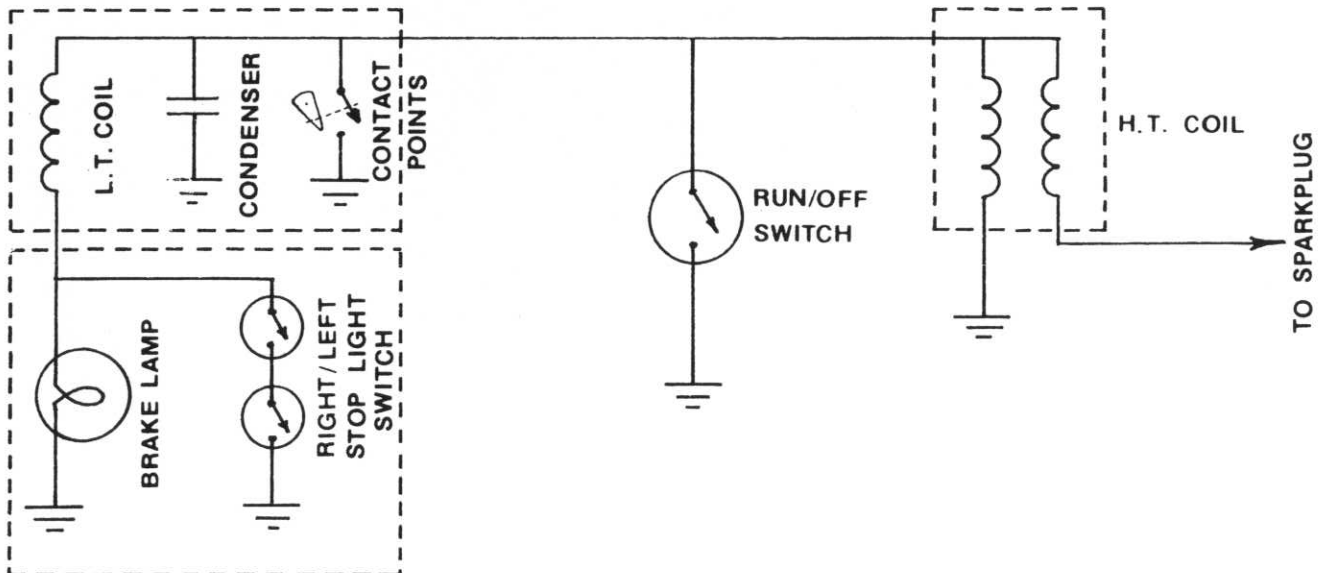
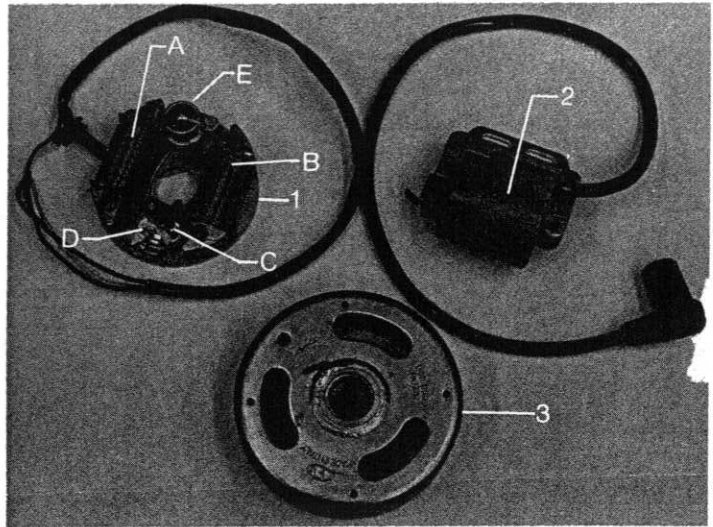

Voltage is generated by the low tension coil (LT coil). This voltage charges the condenser allowing, when the contact points open, a pulse of voltage to the high tension coil (HT coil). This voltage is magnified by the HT coil to provide an arc across the spark plug. The current of the ground side of the LT coil is routed through either the stop lamp filament or the stop lamp switches, depending on the state of the switches.

13. ELECTRICAL/IGNITION SYSTEM

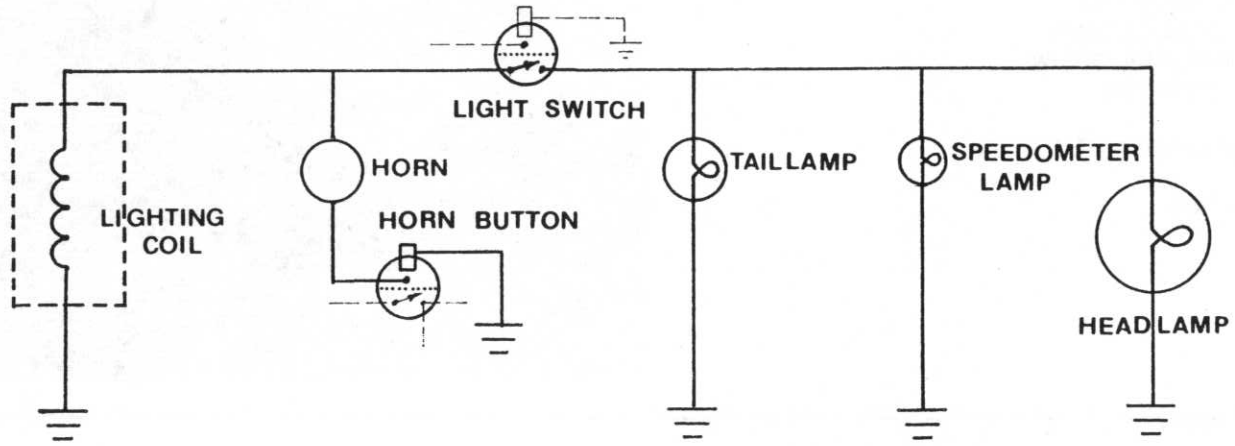

The 25 watt lighting coil generated alternating current (A.C.) which supplies the running lights and horn. The lamps are connected in parallel with the speedometer lamp in the deluxe unit only.

13. ELECTRICAL/IGNITION SYSTEM

SPARK PLUG MAINTENANCE

Every 750 to 1,000 miles the spark plug should be carefully cleaned and gapped. The spark plug gap tolerance is .020" to .024" (.5 to .6 mm). Since the gap will widen under normal use, it is best to set it at its lower setting of .020" (.5 mm).

The plug heat value greatly depends on how the engine is employed. It may be necessary to use a value other than that suggested.

Speed	Bosch	NGK	Champion
17mph	W145T1	B5HS	L-89CM
20mph	W145T1	B5HS	L-89CM
25mph	W175T1	B6HS	L-82
30mph	W225T1	B7HS	L-82

FLYWHEEL MAGNETO MAINTENANCE

Premature wear on the rubbing block causes the contact points gap to narrow. It is therefore very important to perform the proper maintenance to the magneto.

If the flywheel cam is properly cleaned and greased, the rubbing block on the points will suffer very little wear. However, if dust or dirt is allowed to mix with the grease it will create an abrasive substance which will cause premature rubbing block wear. Also if not enough lubrication is provided, the surfaces will become dry, creating friction causing the rubbing block to burn.

- A-Contact points
- B-Cam rider
- C-Grease this surface

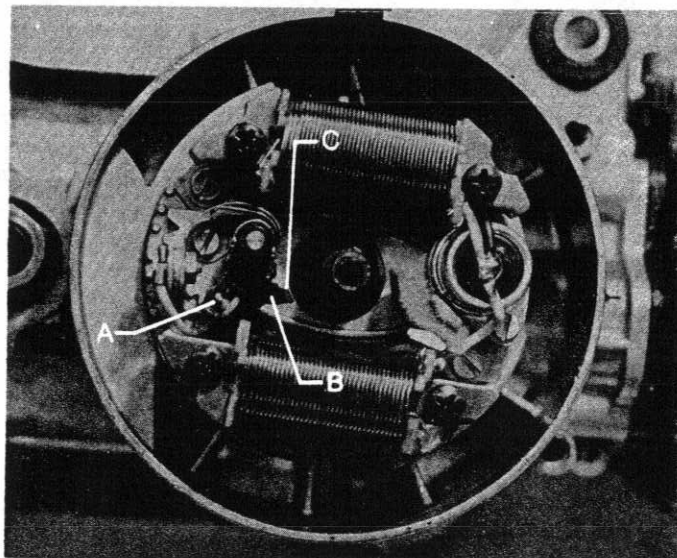

During normal operation burns and pits may develop on the contact points. As a general rule, this does not interfere with operation. However, if the ignition should malfunction as a result of more seriously burned contacts, the contact points must be replaced.

13. ELECTRICAL/IGNITION SYSTEM

SETTING IGNITION CONTACT POINTS AND TIMING

The points and timing are adjusted through the flywheel windows with the flywheel remaining on the engine.

Rotate the flywheel until the points gap is in the widest position. At this point measure the points gap.

Points Gap—.014—.018" (.35 - .45 mm).

To change the point setting loosen the set screw (see illustration). Wedge a small-bladed screwdriver between the notch on the points and the pins on the stator plate. Turning the screwdriver clockwise will open the points gap and turning counter-clockwise will close it. When satisfied that the gap is set correctly, tighten setscrew and check the gap once again.

NOTE: It is helpful to have the bike at the comfortable working level with good lighting.

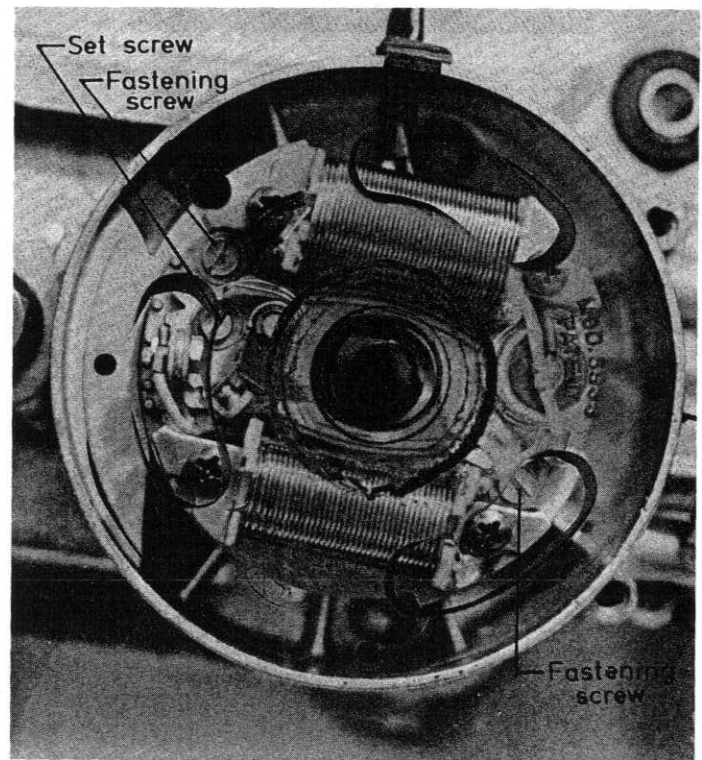
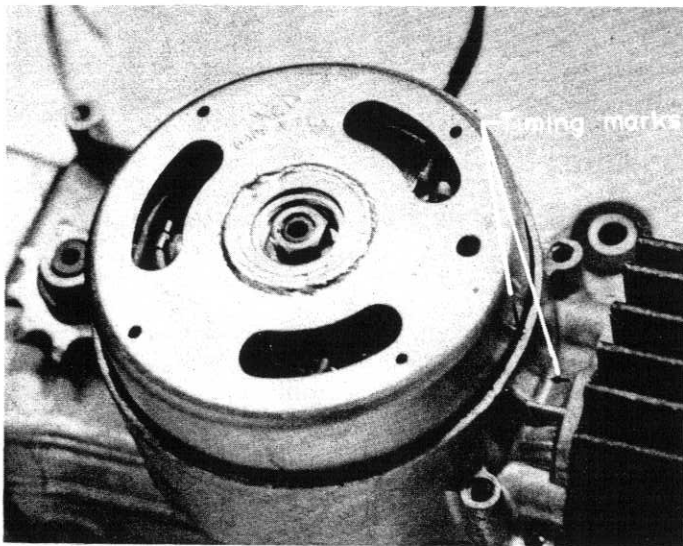

To check the timing rotate the flywheel in the counter-clockwise direction until the contact points just begin to open. This position may be more closely determined with a test light, buzzer, or ohm meter. Connect one lead to the low tension wire that connects to the high tension coil and the other lead to ground. Be certain the run/off switch is in the run position. Rotate the flywheel by hand. The points will be closed when: the test light brightens or the buzzer gets louder or the ohm meter needle deflects to zero. Otherwise the points are in the open position.

When the points just begin to open the timing marks on the flywheel and the crankcase should line up. If they do not, the stator plate may be rotated by loosening the 2 fastening screws (see illustration). This can be done through the windows of the flywheel so that it is not necessary to remove the flywheel. After obtaining the correct timing retighten the 2 fastening screws.

14. CARBURETTOR

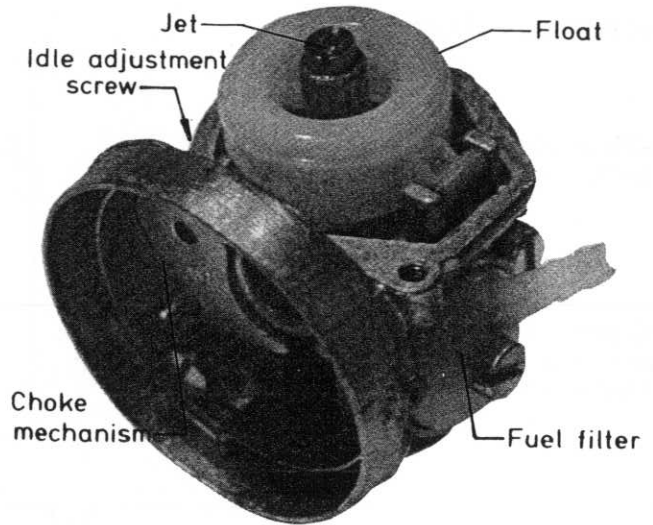
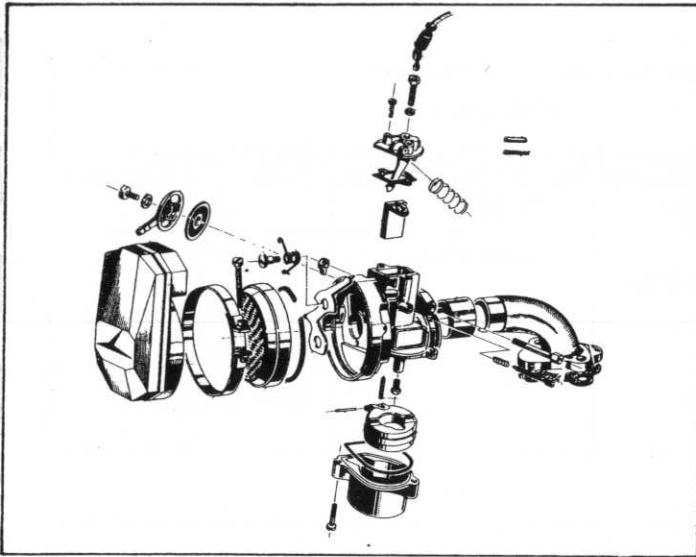

AIR FILTER

The air filter system is designed to regulate the amount of air that flows into the carburetor. It is therefore imperative that the filter and entire filter cover be installed to insure proper air/fuel mixture.

CHOKE

This is a mechanical choke which is mechanically engaged to reduce the throat size so as to restrict the amount of air flowing into the carburetor. This results in an increase in the amount of fuel flowing through the jet.

IDLE ADJUSTMENT

The idle adjustment operates mechanically so as to control how far the carburetor slide will close when in the throttle off state.

The throttle cable should have about 1/8" of slack when turned all the way off. If the cable is adjusted too tight it will interfere with the operation of the idle adjustment.

JET

The carburetor jet vaporizes the fuel in order to get the air/fuel mixture. To insure proper engine performance the jet must be clear of any foreign particles.

Carburetor jet sizes	
17 mph	#48
20 mph	#48
25 mph	#50
30 mph	#50 or 52

FLOAT/NEEDLE AND SEAT

The float is factory set for the proper fuel level and is not adjustable. When cleaning the carburetor the needle and seat should be cleaned and checked for proper seating.

15. TROUBLE SHOOTING

What is trouble shooting?

Trouble shooting is an organized way of determining the cause of malfunction.

This diagram illustrates how a gas engine performs. If there is a problem with an engine, it must be in one of these sections.

FUEL/AIR CARBURETOR/CRANK SEALS/CYLINDER GASKET		
Symptom	Problem	Reason
engine bogs	carburetor	clogged jet
	low vacuum	left or right crank shaft seal base gasket

IGNITION LT COIL/HT COIL/POINTS/ CONDENSER/SPARK PLUG		
Symptom	Problem	Reason
difficult starting	Insufficient spark in combustion chamber	plug gap point gap HT coil bad connection of plug wire to plug cap

COMBUSTION CHAMBER RINGS/CYLINDER/HEAD GASKET/HEAD		
Symptom	Problem	Reason
low power overall poor performance	low compression	worn rings scarred cylinder walls leaking head gasket cracked head

EXHAUST EXHAUST PORT/BAFFLE		
Symptom	Problem	Reason
low power low top speed	restricted exhaust	clogged exhaust port clogged baffle

When trouble shooting an engine it should always be thought of in this perspective. If the section that the trouble lies is not known, then steps of elimination must be taken. For example, when you pull out the spark plug to see if it has fire, you are taking an elimination process. Here you will find out if the ignition process is performing. If the ignition is performing, then you know to check another section. If the ignition section is not performing properly then further steps of elimination must be taken to determine which part of the ignition section is failing. The same is true if another section is found to be malfunctioning.

15. TROUBLE SHOOTING

The following is an actual example of how the problem of no starting or difficult starting should be approached.

