

CLYMER
PUBLICATIONS

PEUGEOT MOPED

OWNER SERVICE / REPAIR

1976-1978

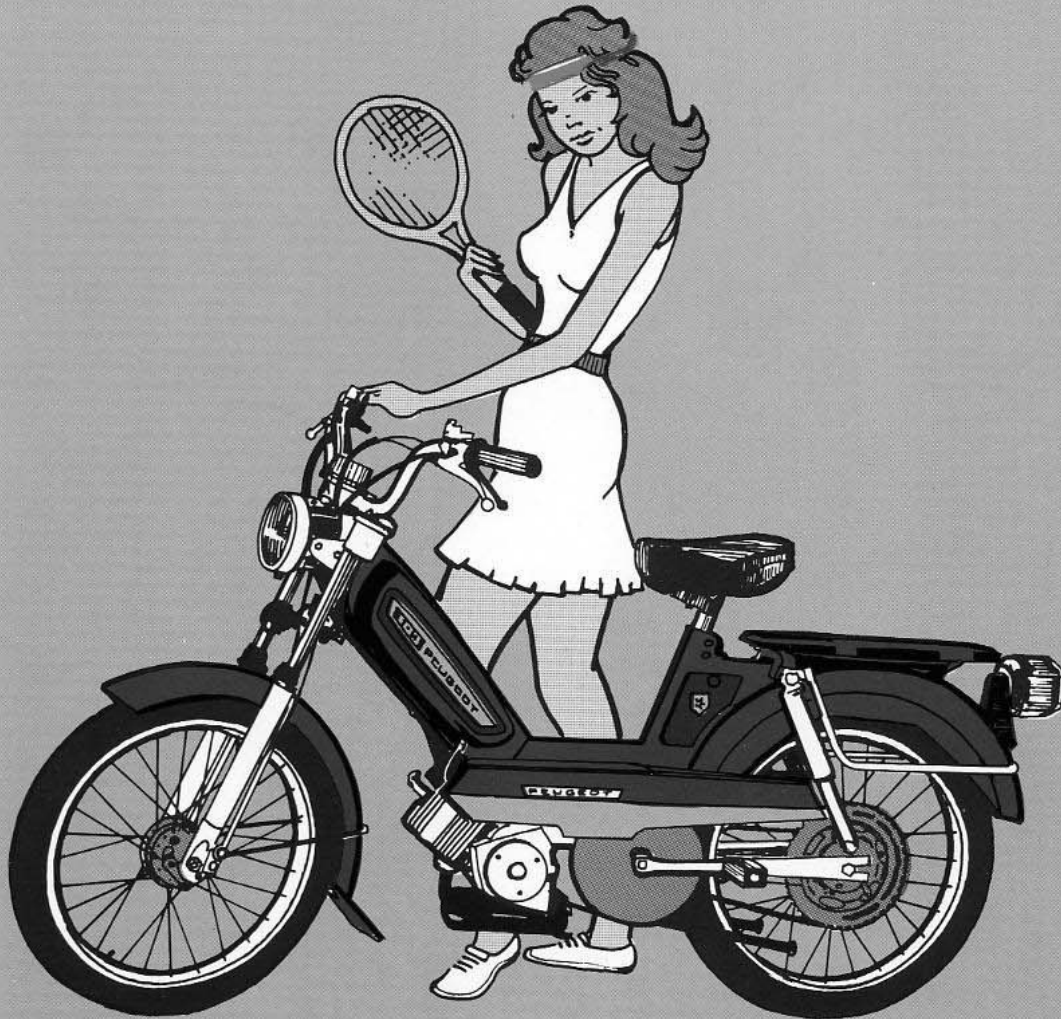

PEUGEOT MOPED

OWNER SERVICE / REPAIR
1976-1978

By
ED SCOTT

ERIC JORGENSEN
Editor

JEFF ROBINSON
Publisher

CLYMER PUBLICATIONS

*World's largest publisher of books devoted exclusively to
automobiles, motorcycles, and boats.*

222 NORTH VIRGIL AVENUE, LOS ANGELES, CALIFORNIA 90004

CONTENTS

CHAPTER ONE

GENERAL INFORMATION 1

- | | |
|---------------------|---------------------|
| Basic components | Safety first |
| Manual organization | Parts replacement |
| Service hints | Expendable supplies |

CHAPTER TWO

BASIC HAND TOOLS 7

- | | |
|--------------------------------|-----------------|
| Fasteners | Torque wrench |
| Screwdrivers | Impact driver |
| Pliers | Ignition gauge |
| Box and open-end wrenches | Tire lever |
| Adjustable (crescent) wrenches | Spoke wrench |
| Socket wrenches | Mechanic's tips |
| Cone wrenches | |

CHAPTER THREE

TUNE-UP, LUBRICATION, AND MAINTENANCE 15

- | | |
|-------------------|----------------------|
| Engine tune-up | Periodic lubrication |
| Lubricants | Periodic maintenance |
| Cleaning solvents | |

CHAPTER FOUR

TROUBLESHOOTING 30

- | | |
|---------------------------|------------|
| Operating requirements | Brakes |
| Emergency troubleshooting | Electrical |
| Engine | Suspension |
| Clutch | |

CHAPTER FIVE

ENGINE 34

- | | |
|-------------------------|--------------------------------|
| Principles of operation | Piston cleaning and inspection |
| Lubrication | Piston ring |
| Cooling | Decompressor valve |
| Removal/installation | Crankshaft seal |
| Cylinder head | Intake valve |
| Cylinder | Splitting the crankcase |
| Piston and wrist pin | |

INDEX

- A**
- Air filter60-61
- B**
- Bicycle chain27, 53-54
- Bolts8, 12-14
- Brakelight 67
- Brakes
- Adjustment27-28
- Cable71-72
- Drum 73
- Lining72-73
- Troubleshooting 33
- Breaker points22-23, 64-65
- C**
- Carburetor
- Cleaning 58
- Overhaul 58
- Removal and installation57-58
- Tune-up adjustment 23
- Chains26-27, 53-55
- Clutch
- Assembly48-50
- Disassembly46-48
- Inspection 48
- Installation50-51
- Removal45-46
- Troubleshooting 33
- Components, description 1-4
- Condenser 64
- Cooling system 34
- Crank arm52-53
- Crankcase splitting 44
- Crankshaft seal 43
- Cylinder38-40
- Cylinder head36-38
- D**
- Decarbonizing24-25
- Decompressor valve 42
- Description 1-4
- Drive chain26, 53-55
- Drive pulley28, 55-56
- E**
- Electrical system
- Accessories and instruments65-70
- Magneto63-65
- Troubleshooting 33
- Emergency troubleshooting 31
- Engine**
- Cooling 34
- Crankcase splitting 44
- Crankshaft seal 43
- Cylinder38-40
- Cylinder head36-38
- Decompressor valve 42
- Intake valve43-44
- Lubrication 34
- Operating principles 34
- Piston and wrist pin40-41
- Piston cleaning and inspection 41
- Piston ring41-42
- Removal and installation34-36
- Troubleshooting31-33
- Exhaust system61-62
- F**
- Fork, front86-88
- Frame
- Fork, front86-88
- Handlebar82-83
- Headset83-86
- Seat 90
- Wheels and hubs74-87
- Fuel system
- Air filter60-61
- Carburetor57-58
- Fuel filter 60
- Fuel shutoff valve 60
- G**
- General information 1-6
- H**
- Handlebar82-83
- Headlight 66
- Headset83-86
- Horn33, 68
- Hubs76-77
- I**
- Ignition gauge 12
- Ignition timing18-22
- Impact driver 12
- Intake valve43-44
- L**
- Lighting system33, 65-68
- Lubricants25-26
- Lubrication26, 34

CHAPTER ONE

GENERAL INFORMATION

Although mopeds have long been a favorite in Europe, it is only recently that they have become popular in the United States. Today they are more numerous and are ridden more often than ever before.

The majority of moped dealers also sell bicycles or motorcycles. The number of competent mechanics available cannot keep pace with the demand. Moped owners must often do their own maintenance and repair.

Moped maintenance and repair is not difficult if you know what tools to use and what to do. Anyone not afraid to get his or her hands dirty, of average intelligence, and with enough mechanical ability to change a light bulb can perform most of the procedures in this book.

In some cases, a repair job may require tools or skills not reasonably expected of the home mechanic. These instances are noted in each chapter and it is recommended that you take the job to your dealer, competent mechanic, or machine shop.

BASIC COMPONENTS

Basically the moped is an engine powered bicycle. It has two pedals and can be ridden as an ordinary bicycle without running the engine. **Figure 1** shows the major components of a moped.

Frame

A heavy duty, step-through bicycle frame with provisions for an engine.

Engine

The engine is a very simple one-cylinder, 2-stroke engine cooled by air. It produces approximately 2 horsepower. This is the same type of engine used on outboard motors, lawn mowers, and many motorcycles. It is very reliable and easy to maintain.

Clutch/Transmission

The clutch/transmission is automatic, that is, there are no gears to shift and no clutch pedal or lever to worry about. The engine power is transferred to the rear wheel by a drive chain just like on a bicycle or motorcycle.

Suspension

Spring-type front forks and rear shock absorbers smooth out rough roads. These are similar to those used on motorcycles but are simpler and require very little maintenance.

Brakes

The brakes are operated by levers on the handlebars similar to those used on bicycles and

PEUGEOT 103 MAJOR COMPONENTS

1

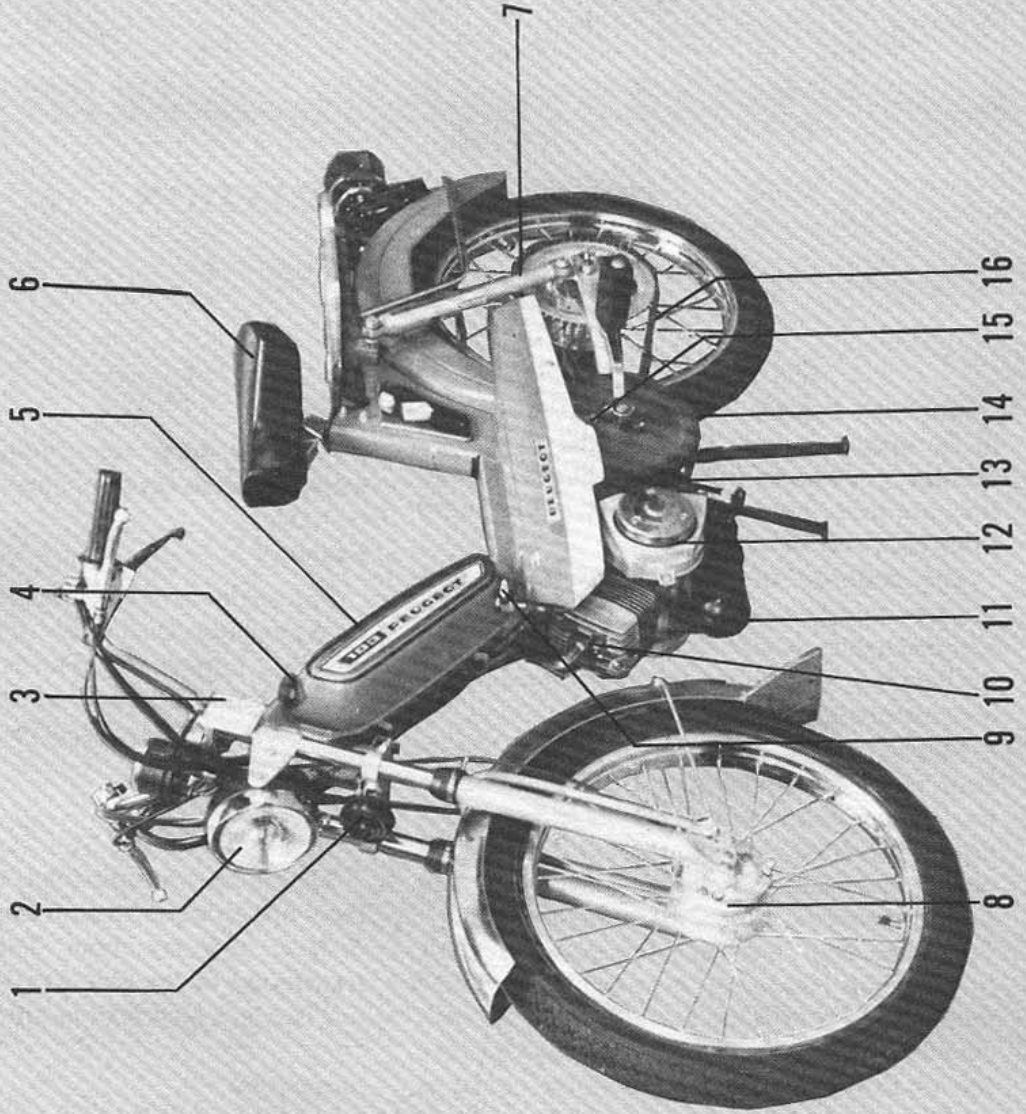

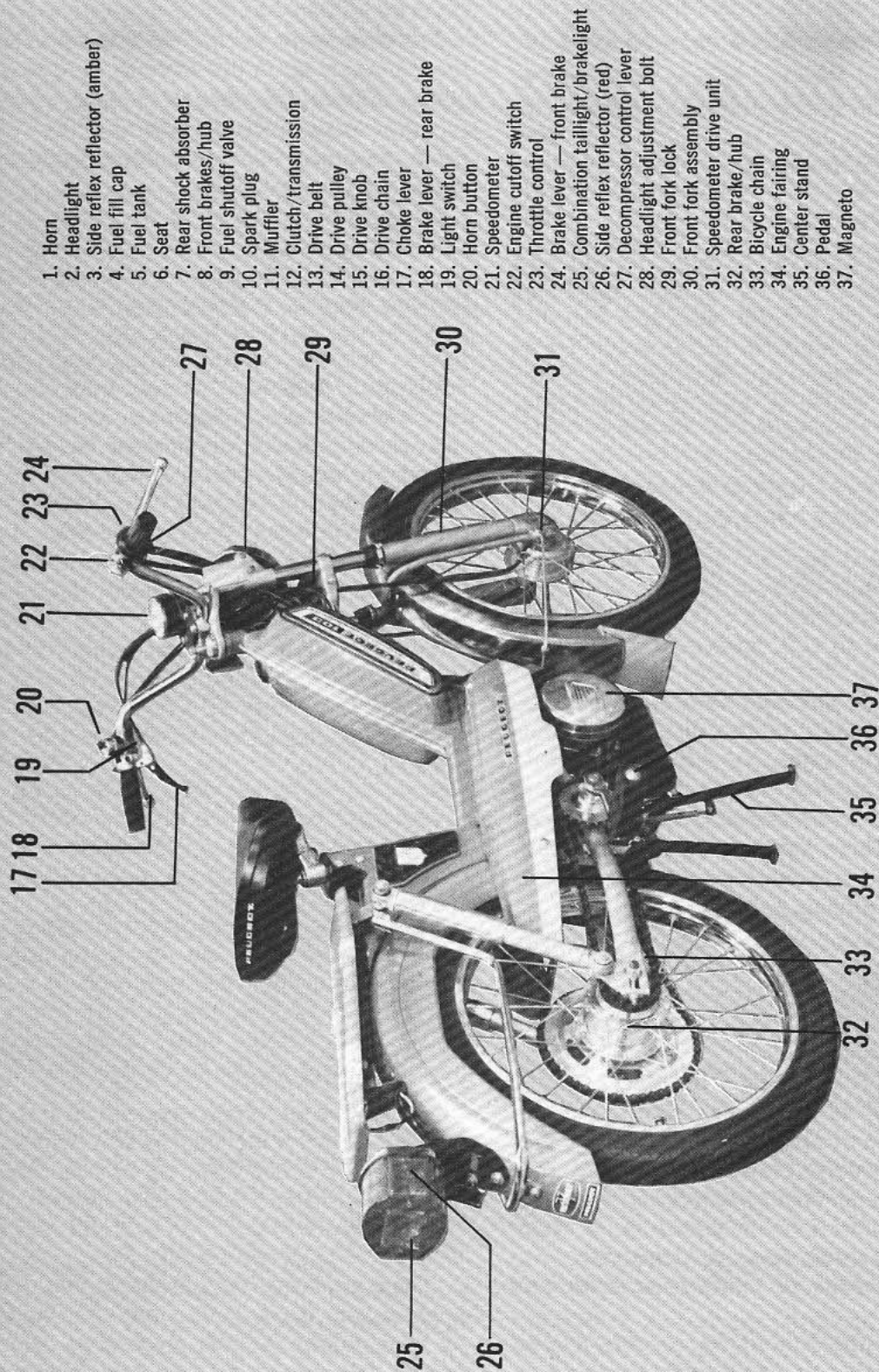

1. Horn
2. Headlight
3. Side reflex reflector (amber)
4. Fuel fill cap
5. Fuel tank
6. Seat
7. Rear shock absorber
8. Front brakes/hub
9. Fuel shutoff valve
10. Spark plug
11. Muffler
12. Clutch/transmission
13. Drive belt
14. Drive pulley
15. Drive knob
16. Drive chain
17. Choke lever
18. Brake lever — rear brake
19. Light switch
20. Horn button
21. Speedometer
22. Engine cutoff switch
23. Throttle control
24. Brake lever — front brake
25. Combination taillight/brake light
26. Side reflex reflector (red)
27. Decompressor control lever
28. Headlight adjustment bolt
29. Front fork lock
30. Front fork assembly
31. Speedometer drive unit
32. Rear brake/hub
33. Bicycle chain
34. Engine fairing
35. Center stand
36. Pedal
37. Magneto

1

1

motorcycles. The left hand operates the rear brakes and the right hand, the front brakes.

Wheels and Tires

Wheels and tires are basically the same as those used on bicycles except that they are a little heavier in order to accommodate the additional weight of the moped.

Lighting and Instruments

There is no battery to be concerned with on a moped. The electricity for lights and spark plug is provided by a small generator called a magneto. It is similar to the generator on an automobile. The only instrument is the speedometer and it is illuminated for use at night.

MANUAL ORGANIZATION

This manual provides service information and instructions for your moped. All dimensions and capacities are expressed in English units familiar to U.S. mechanics as well as in metric units.

This chapter provides general information and specifications. It also identifies and explains all of the major components.

Chapter Two explains selection and use of the tools you will need to work on your moped.

Chapter Three explains all periodic lubrication and routine maintenance necessary to keep your moped running well.

Chapter Four provides methods and suggestions for quick and accurate diagnosis and repair of problems. Troubleshooting procedures discuss typical logical methods to pinpoint the trouble.

Subsequent chapters describe specific systems such as the engine, clutch/transmission, and electrical system. Each chapter provides disassembly, repair and assembly procedures in simple step-by-step form. If repair is impractical for a home mechanic, it is indicated. It is usually faster and less expensive to take such repairs to a dealer or competent repair shop.

Some of the procedures in this manual specify special tools. In all cases, the tool is illustrated either in actual use or alone. A well-

equipped mechanic may find that he can substitute similar tools already on hand or can fabricate his own.

The terms NOTE, CAUTION and WARNING have specific meanings in this manual. A NOTE provides additional information to make a step or procedure easier or clearer. Disregarding a NOTE could cause inconvenience, but would not cause damage or personal injury.

A CAUTION emphasizes areas where equipment damage could result. Disregarding a CAUTION could cause permanent equipment damage; however, personal injury is unlikely.

A WARNING emphasizes areas where personal injury or even death could result from negligence. Mechanical damage may also occur. WARNINGS are to be taken seriously. In some cases, serious injury or death has resulted from disregarding similar warnings.

Throughout this manual keep in mind two conventions. "Front" refers to the front of the moped. The front of any component such as the engine is the end which faces toward the front of the moped. The left and right side refer to a person sitting on the seat facing forward. For example, the clutch/transmission is on the left side. These rules are simple, but even experienced mechanics occasionally become disoriented.

SERVICE HINTS

Most of the service procedures covered are straightforward and can be performed by anyone reasonably handy with tools. It is suggested, however, that you consider your own capabilities carefully before attempting any operation involving major disassembly of the engine.

1. Some operations, for example, require the use of a hydraulic press. It would be wiser to have these performed by a shop equipped for such work, rather than try to do the job yourself with makeshift equipment.

2. There are many items available that can be used on your hands before and after working on your moped. A little preparation prior to getting "all greased up" will help cleaning up later.

Before starting on your task, work Vaseline, soap, or a commercially available product like ProTek into your hands and under your fingernails and cuticles. This will make cleanup a lot easier.

3. For cleanup use a waterless hand soap, like Sta-Lube, and finish up with powdered Boraxo and a fingernail brush.

4. Repairs go much easier and faster if your moped is clean before you begin work. There are special cleaners like, Gunk Cycle Degreaser, for washing the engine and related parts. Follow the manufacturer's instructions. Clean all oily or greasy parts with cleaning solvent as you remove them.

WARNING

Never use gasoline as a cleaning solvent. It prevents an extreme fire hazard. Be sure to work in a well-ventilated area when using cleaning solvent. Keep a fire extinguisher, rated for gasoline fires, handy in any case.

5. Special tools are required for some repairs. These may be purchased at a dealer, rented from a tool rental dealer or fabricated by a mechanic or machinist, often at a considerable savings.

6. Much of the labor charge for repairs made by dealers is for the removal and disassembly of other parts in order to reach the defective unit. It is frequently possible to perform the preliminary operations yourself and then take the defective unit to the dealer for repair at considerable savings.

7. Once you have decided to tackle the job yourself, read the entire section in this manual which pertains to it. Study the illustrations, photos and text until you have a good idea of what is involved in completing the job satisfactorily. If special tools are required, make arrangements to get them before you start. It is frustrating and time consuming to get partly into a job and then be unable to complete it.

8. During disassembly of parts, keep a few general cautions in mind. Force is rarely needed to get things apart. If parts have a tight fit, like a bearing in a case, there is usually a tool designed to separate them. Never use a screw-

driver to pry apart parts with machined surfaces, such as crankcase halves. You will mar the surfaces and end up with leaks.

9. Make diagrams whenever similar-appearing parts are found. For instance, crankcase studs are not the same length. You may think you can remember where everything came from — but mistakes could be costly. There is also the possibility you may be sidetracked and not return to work for days or even weeks — in which interval carefully laid out parts may have become disturbed.

10. Tag all similar internal parts for location and mark all mating parts for position. Record numbers and thickness of any shims as they are removed. Small parts such as bolts can be identified by placing them in plastic sandwich bags. Seal and label with masking tape.

11. Wiring should be tagged with masking tape and marked as each wire is removed. Again, do not rely on memory alone.

12. Protect finished surfaces from physical damage or corrosion. Keep gasoline off of painted surfaces.

13. Frozen or very tight bolts and screws can often be loosened by soaking with penetrating oil, like Liquid Wrench or WD-40, then sharply striking the bolt head a few times with a hammer and punch (or screwdriver for screws). Avoid heat unless absolutely necessary, since it may melt, warp, or remove the temper from many parts.

14. Avoid flames or sparks when working near flammable liquids, such as gasoline.

15. No parts, except those assembled with a press fit, require force during assembly. If a part is hard to remove or install, find out why before proceeding.

16. Cover all openings after removing parts to keep dirt, small tools, etc., from falling in.

17. When assembling two parts, start all fasteners, then tighten evenly.

18. Clutch/transmission parts, wiring connections, and brake shoes should be kept clean and free of grease and oil.

19. When assembling parts, be sure that all shims and washers are replaced exactly as they came out.

20. Whenever a rotating part butts against a stationary part, look for a shim or washer. Use new gaskets if there is any doubt about the condition of the old ones. Generally you should apply gasket cement to one mating surface only so the parts may be disassembled in the future. A thin coat of oil on gaskets helps them seal effectively.

21. Heavy grease can be used to hold small parts in place if they tend to fall out during assembly. However, keep grease and oil away from electrical components, brake and clutch parts.

22. Carbon can be removed from the head and top of the piston with a dull screwdriver. Do not scratch either surface. Then wipe off the surfaces with a clean cloth.

23. Carburetors are best cleaned by disassembling them and soaking the parts in a commercial carburetor cleaner. Never soak gaskets or plastic or rubber parts in these cleaners. Never use wire to clean out the jet and air passages; they are easily damaged. Use compressed air to blow out the carburetor only if the float has been removed first.

Take your time and do the job right. Do not forget that a newly rebuilt engine must be broken in the same as a new one.

SAFETY FIRST

Professional mechanics can work for years and never sustain a serious injury. If you observe a few rules of common sense and safety, you can enjoy many safe hours servicing your own moped. You could hurt yourself or damage the moped if you ignore these rules.

1. Never use gasoline as a cleaning solvent.

2. Never smoke or use a torch in the vicinity of flammable liquids, such as cleaning solvent in open containers.

3. Use the proper sized wrenches to avoid damage to nuts and injury to yourself.

4. When loosening a tight or stuck nut, be guided by what would happen if the wrench should slip. Protect yourself accordingly.

5. Keep your work area clean and uncluttered.

6. Wear safety goggles during all operations involving drilling, grinding, or use of a cold chisel.

7. Never use worn tools.

8. Keep a fire extinguisher handy and be sure it is rated for gasoline and electrical fires.

PARTS REPLACEMENT

Manufacturers make frequent changes during the model year; some relatively major. When you order parts from the dealer or other parts distributors, always order by engine and frame number. Write the numbers down and carry them with you. Compare new parts to old before purchasing them. If they are not alike, have the parts manager explain the difference to you.

EXPENDABLE SUPPLIES

Certain expendable supplies are also required. These include grease, oil, gasket cement, wiping rags, and cleaning solvent. Ask your dealer for the special locking compounds, silicone lubricants, and commercial chain cleaners and lubrication products which make moped maintenance simpler and easier. Solvent is available at most service stations.

CHAPTER TWO

BASIC HAND TOOLS

A number of tools are required to maintain a moped in top condition. You may already have some around for other work such as home and car repairs. There are also tools made especially for moped repair; these you will have to purchase. In any case, a wide variety of quality tools will make moped repairs more effective and convenient.

Top quality tools are essential — and also more economical. Poor grade tools are made of inferior materials, and are thick, heavy, and clumsy. Their rough finish makes them difficult to clean and they usually don't stand up long.

Quality tools are made of alloy steel and are heat treated for greater strength. They are lighter and better balanced than inferior ones. Their surface is smooth, making them a pleasure to work with and easy to clean. The initial cost of top quality tools may be relatively high, but longer life and ease of use make them less expensive in the long run.

It is aggravating to search for a certain tool in the middle of a repair, only to find it covered with grime. Keep your tools in a tool box. Keep wrench sets, socket sets, etc., together. After using a tool, wipe off dirt and grease with a clean cloth and replace the tool in its correct place.

This chapter describes various hand tools required to perform virtually any repair job on a

moped. Each tool is described and recommendations as to proper size are made for those not familiar with hand tools. **Table 1** includes tools for emergency repairs on the road. **Table 2** includes tools which should be on hand at home for simple repairs or major overhaul.

FASTENERS

In order to better understand and select basic hand tools, a knowledge of various fasteners used on mopeds is important. This knowledge will also aid selecting replacements when fasteners are damaged or corroded beyond use.

Threads

Nuts, bolts, and screws are manufactured in a wide range of thread patterns. To join a nut and bolt, it is necessary that the bolt and the diameter of the hole in the nut be the same. It is equally important that the threads on both be properly matched.

The best way to insure that threads on two fasteners are compatible is to turn the nut on the bolt with fingers only. If much force is required, check the thread condition on both fasteners. If thread condition is good, but the fasteners jam, the threads are not compatible. Take the fasteners to a hardware store or moped dealer for proper mates.

Table 1 EMERGENCY TOOL KIT

Tool	Size or Specification
Common screwdriver	Choose smallest tools possible to fit small carrying pouch.
Combination wrench 8 x 10mm	
Cone wrenches	
Tire levers	
Tire patch kit	

Table 2 HOME WORKSHOP TOOLS

Tool	Size or Specification
Screwdrivers	
Slot	$\frac{5}{16}$ x 8 in. blade
Slot	$\frac{3}{8}$ x 12 in. blade
Phillips	Size 2 tip, 6 in. blade
Pliers	
Gas pliers	6 in. overall
Vise Grips®	10 in. overall
Needle nose	6 in. overall
Channel lock	12 in. overall
Snap ring	—
Wrenches	
Box-end set	10-17, 20, 32mm
Open-end set	10-17, 20, 32mm
Crescent (adjustable)	6 and 12 in. overall
Socket set	$\frac{1}{2}$ in. drive ratchet with 10-17, 20, 32mm sockets
Allen set	2-10mm
Cone wrenches	—
Spoke wrench	—
Other Special Tools	
Impact driver	$\frac{1}{2}$ in. drive with ass't tips
Torque wrench	$\frac{1}{2}$ in. drive — 0-100 ft.-lb.
Tire levers	For moped or motorcycle tires

Most fasteners are cut so that a fastener must be turned clockwise to tighten it. These are called right-hand threads. Some moped components, such as pedals, have left-hand threads; they must be turned counterclockwise to tighten them.

NOTE: When replacing threaded components, rely on your dealer's experience; take the old part in for replacement.

Machine Screws

There are many different types of machine screws. **Figure 1** shows a number of screw heads requiring different types of turning tools. Heads are also designed to protrude above the metal (round) or to be slightly recessed in the metal (flat).

When replacing a damaged screw, take it to a hardware store or moped dealer. Match the head type, diameter, and threads exactly. In addition, match the type of metal used. For example, if the old screw is chrome plated, the new one must be chrome plated also to resist corrosion and rust.

Bolts

Commonly called bolts, the technical name for these fasteners is cap screws. They are normally specified by diameter, threads-per-inch (tpi), and length, e.g., $\frac{1}{4}$ -20 x 1 specifies a bolt $\frac{1}{4}$ in. in diameter with 20 tpi 1 in. long. The measurement across two flats on the head of the bolt indicates the proper wrench size to be used.

When replacing damaged bolts, follow the same advice given for machine screws.

Nuts

Nuts are manufactured in a variety of types and sizes. Most nuts on mopeds are hexagonal (6-sided) and fit on bolts, screws and studs with the same diameter and threads-per-inch.

Figure 2 shows several nuts usually found on mopeds. The common nut (A), is normally used with a lockwasher. The nut (B) has a nylon insert which prevents the nut from loosening and does not require a locknut. To indicate the size of the nut, manufacturer's specify the diameter of the opening and the threads-per-inch (tpi), e.g., $\frac{1}{4}$ -20 indicates a $\frac{1}{4}$ in. opening and 20 tpi. This is, of course, the same as for bolts, but with no length dimension given. In addition, the measurement across two flats on the nut indicates the proper wrench size to be used.

When replacing a damaged nut, take it to a hardware store or moped dealer. Match the type, diameter, and threads exactly. In addition, match the type of metal used, e.g., chrome plating to resist rust and corrosion.

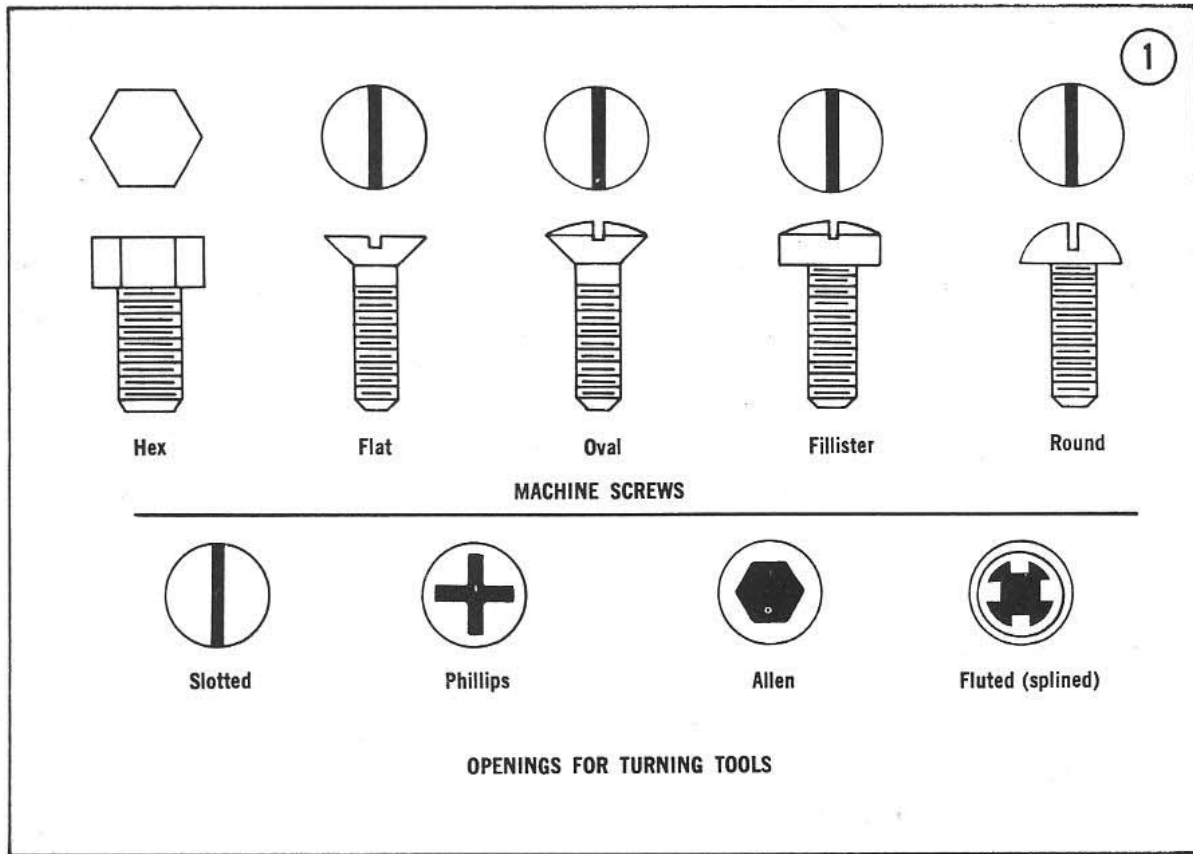

2

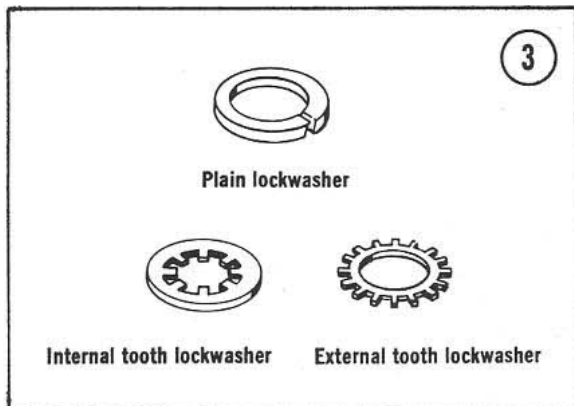
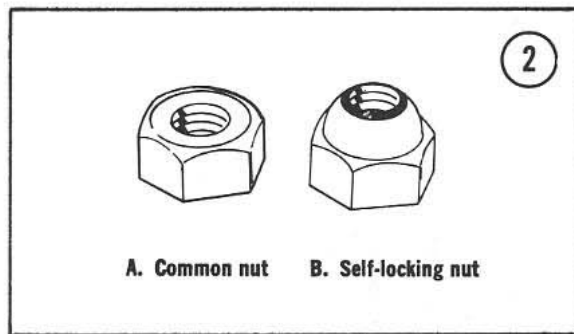

Washers

There are two major types of washers — flat washers and lockwashers. Flat washers are simple discs with a hole to fit a screw or bolt. Lockwashers are designed to prevent a fastener from working loose, due to vibration, expansion, and contraction. **Figure 3** shows several washers. Note that flat washers are often used between a lockwasher and a fastener to act as a smooth bearing surface. This permits the fastener to be turned easily with a tool.

SCREWDRIVERS

The screwdriver is a very basic tool, but many people don't use it properly and consequently, do more damage than good. The slot on a screw has a definite dimension and shape. A screwdriver must be selected to conform to that shape. A small screwdriver in a large slot will twist the screwdriver out of shape and damage the slot. A large screwdriver on a small slot will also damage the slot. In addition, since

the sides of the screw slot are parallel, the sides of the screwdriver near the tip must be parallel. If the tip sides are tapered, the screwdriver wedges itself out of the slot; this makes the screw difficult to remove and may damage the slot.

Two basic types of screwdrivers are required to repair the moped — a common screwdriver and a Phillips screwdriver. Both types are illustrated in **Figure 4**.

Screwdrivers are available in sets which often include an assortment of common and Phillips blades. If you purchase individual screwdrivers, as a minimum obtain:

- a. Common screwdriver, $\frac{5}{16}$ x 6 in. blade
- b. Common screwdriver, $\frac{3}{8}$ x 12 in. blade
- c. Phillips screwdriver, size 2, 6 in. blade

Use screwdrivers only for driving screws. Never use a screwdriver for prying or chiseling. In addition, never use a common screwdriver to remove a Phillips or Allen head screw; you can damage the head so that even the proper tool cannot remove the screw.

Keep screwdrivers in proper condition and they will last longer and perform better. Always keep the tip in good condition. **Figure 5** shows how to grind the tip to proper shape if it is damaged. Note the parallel sides at the tip.

PLIERS

Pliers come in a wide range of types and sizes. Pliers are useful for cutting, bending, and crimping. They should never be used to cut hardened objects or to turn nuts or bolts. **Figure 6** shows several pliers useful in moped repairs.

Each type of pliers has a specialized function. Gas pliers are general purpose and are used mainly for holding things and bending. Vise Grips are used as pliers or to grip objects very tightly like a vise. Needle nose pliers are used to hold or bend small objects. Channel lock pliers can be adjusted to hold various size objects; the jaws remain parallel to grip round objects such as pipe or tubing. There are many more types of pliers. The ones described here are most suitable for moped repairs.

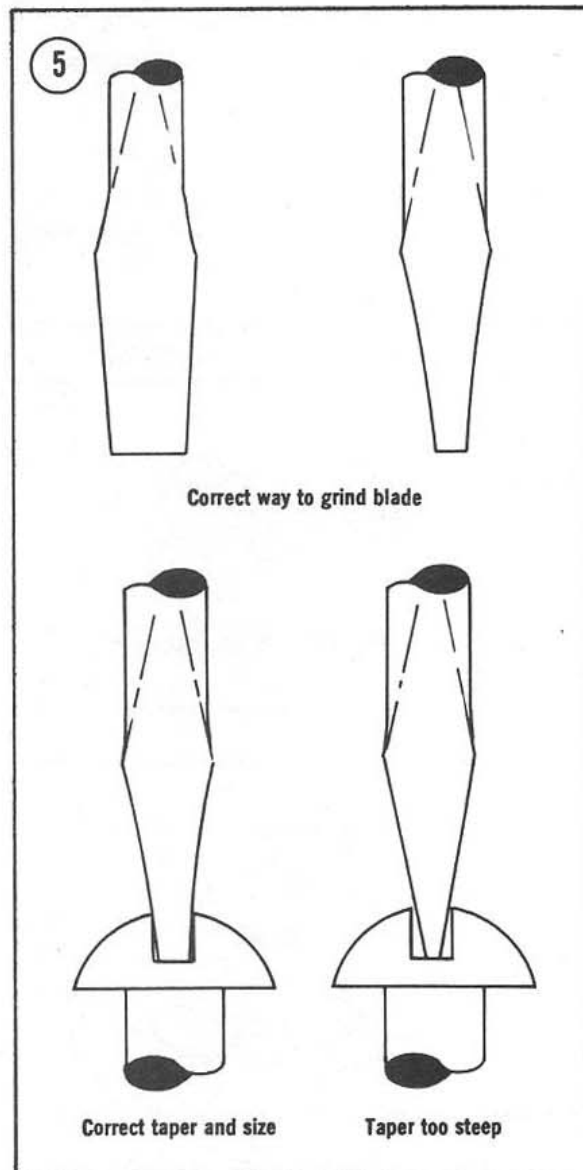
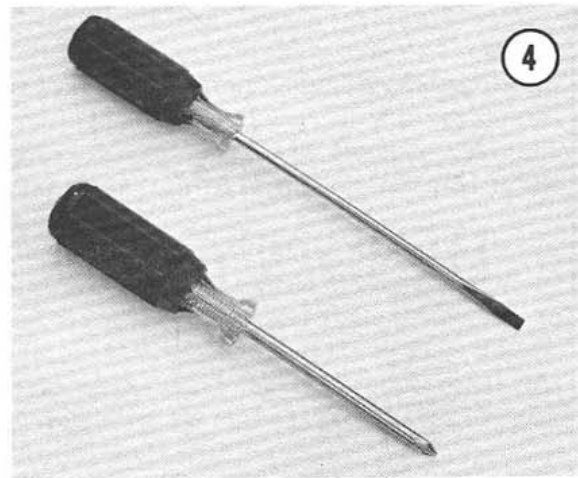

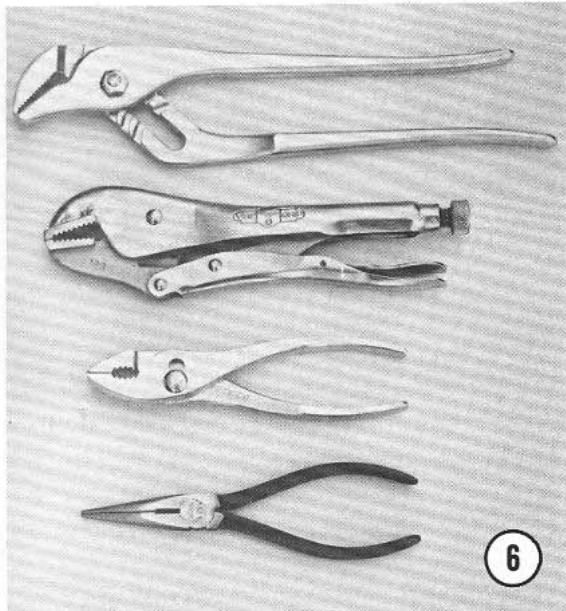

6

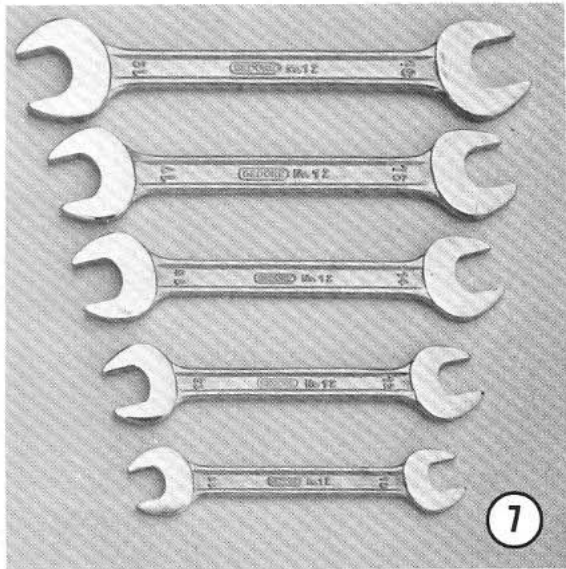

7

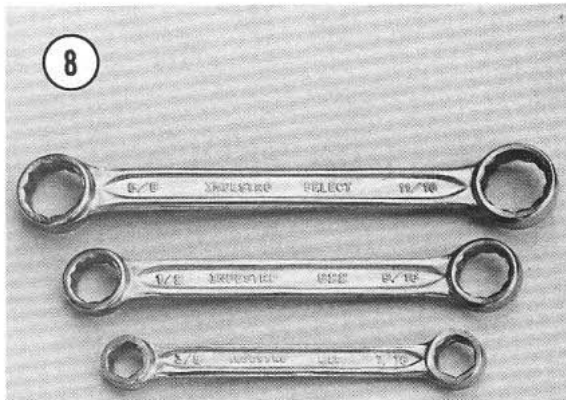

8

BOX AND OPEN-END WRENCHES

Box wrenches and open-end wrenches are available in sets or separately in a variety of sizes. See **Figure 7 and 8**. The size stamped near the end refers to the distance between two parallel flats on a hex head bolt or nut.

A set covering 10 to 17mm and 21mm is adequate for service on the moped.

Box wrenches are usually superior to open-end wrenches. Open-end wrenches grip a nut on only 2 flats. Unless it fits well, it may slip and round off the points on the nut. The box wrench grips all 6 flats. Both 6-point and 12-point openings on box wrenches are available. The 6-point gives superior holding power; the 12-point allows a shorter swing.

Combination wrenches which are open on one end and boxed on the other are also available. Both ends are the same size.

ADJUSTABLE (CRESCENT) WRENCHES

An adjustable wrench (also called crescent wrench) can be adjusted to fit nearly any nut or bolt head. See **Figure 9**. However, it can loosen and slip, causing damage to the nut. Use only when other wrenches are not available.

Crescent wrenches come in sizes ranging from 4-18 in. overall. A 6 or 8 in. wrench is recommended as an all-purpose wrench.

SOCKET WRENCHES

This type is undoubtedly the fastest, safest, and most convenient to use. See **Figure 10**. Sockets which attach to a ratchet handle are available with 6-point or 12-point openings and 1/4, 3/8, 1/2, and 3/4 inch drives. The drive size indicates the size of the square hole which mates with the ratchet handle. Sockets are available in metric and inch sizes.

CONE WRENCHES

Cone wrenches are nothing more than especially thin open-end wrenches. See **Figure 11**. These wrenches are available separately or in sets of metric or inch sizes. Obtain the size required for your moped; they are available at most moped and bicycle dealers.

TORQUE WRENCH

Torque wrench is used with a socket to measure how tight a nut or bolt is installed. See **Figure 12**. They come in a wide price range and with either $\frac{3}{8}$ or $\frac{1}{2}$ in. square drive. The drive size indicates the size of the square drive which mates with the socket. An inexpensive one that measures from 1-100 ft.-lb. (0-140 N·m) retails for about \$15.

IMPACT DRIVER

This tool might have been designed with the moped in mind. See **Figure 13**. It makes removal of engine and clutch parts easy and eliminates damage to bolts and screw slots. A good one runs about \$15 at large hardware or auto parts stores.

IGNITION GAUGE

This tool measures point gap. It also has round wire gauges for measuring spark plug gap. See **Figure 14**. A good one runs about \$3 and is available at most auto or motorcycle supply stores.

TIRE LEVER

These are used to remove or install moped tires. See **Figure 15**. Check the working end of the tool before use and remove any burrs. Never use a screwdriver in place of a tire lever. Chapter Ten explains its use.

SPOKE WRENCH

This special wrench is used to tighten spokes (**Figure 16**). It is available at most moped or motorcycle supply shops.

MECHANIC'S TIPS

Removing Frozen Nuts and Screws

When a fastener rusts and cannot be removed, several methods may be used to loosen it. First, apply penetrating oil such as Liquid Wrench or WD-40 (available at any hardware or auto supply store). Apply it liberally. Rap the fastener several times with a small hammer; don't hit it hard enough to cause damage.

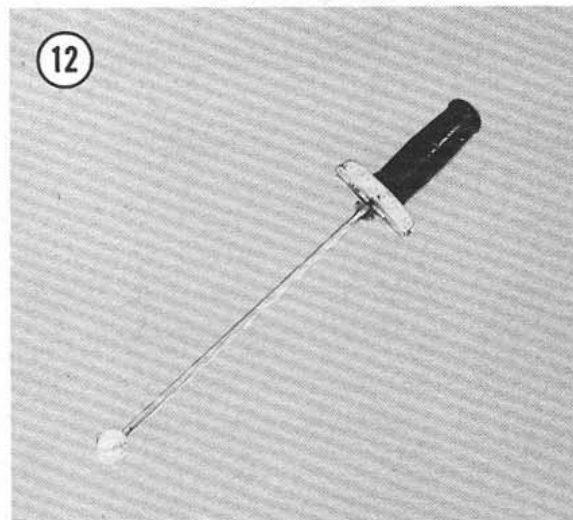
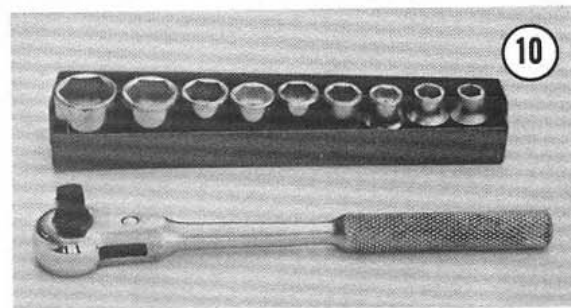
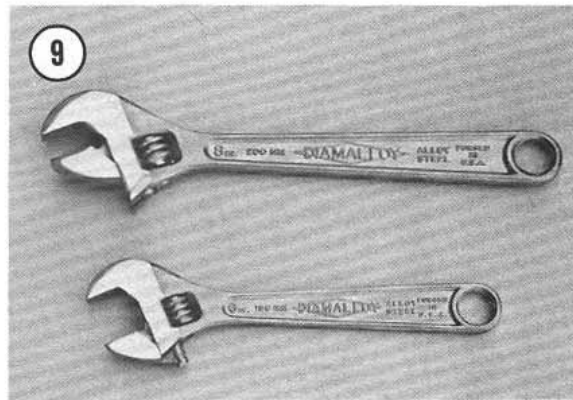

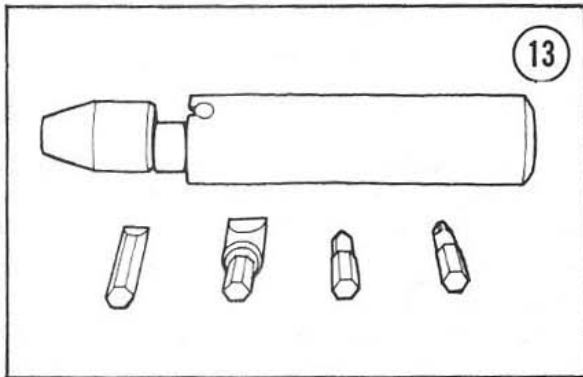

For frozen screws, apply oil as described, then insert a screwdriver in the slot and rap the top of the screwdriver with a hammer. This loosens the rust so the screw can be removed in the normal way. If the screw head is too chewed up to use a screwdriver, grip the head with Vise Grip pliers and twist the screw out.

For a frozen bolt or nut, apply penetrating oil, then rap it with a hammer. Remove with a proper size wrench. If the points are rounded off, grip with Vise Grip pliers as described for screws.

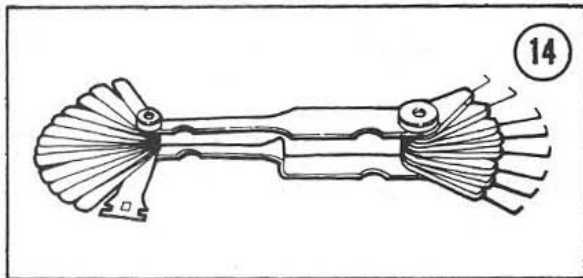

Remedying Stripped Threads

Occasionally, threads are stripped through carelessness or impact damage. Often the threads can be cleaned up by running a tap (for internal threads on nuts) or die (for external threads on bolts) through the threads. See Figure 17.

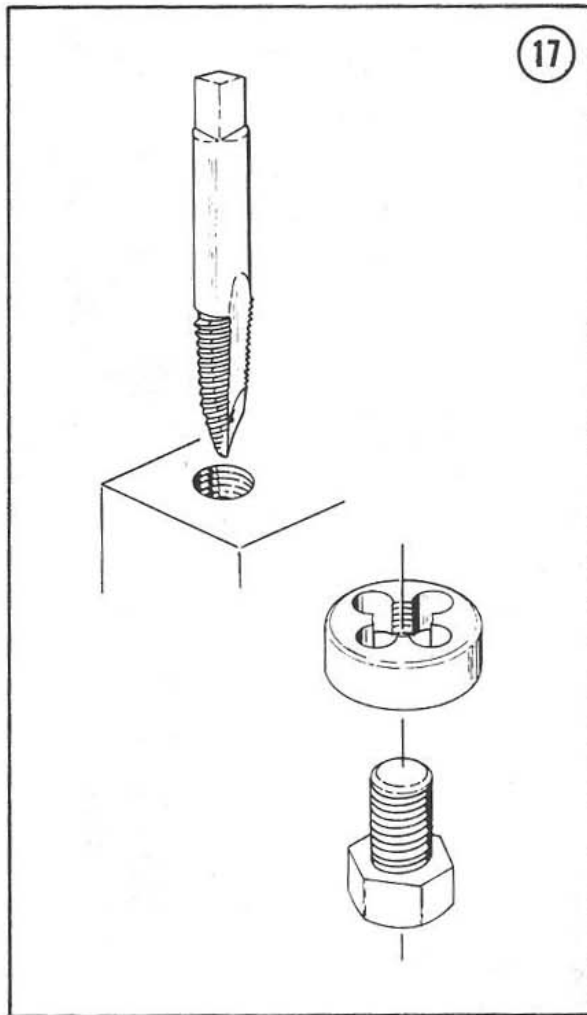
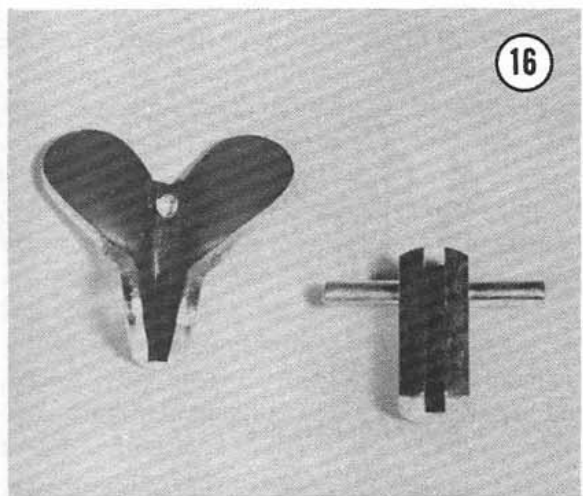
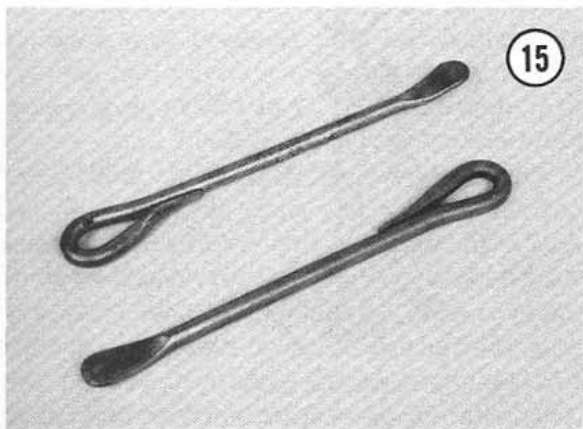

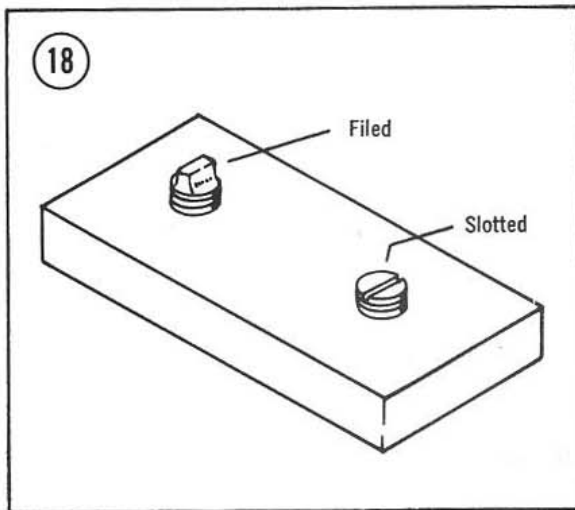

Removing Broken Screws or bolts

When the head breaks off a screw or bolt, several methods are available for removing the remaining portion.

If a large portion of the remainder projects out, try gripping it with Vise Grips. If the projecting portion is too small, try filing it to fit a wrench or cut a slot in it to fit a screwdriver (Figure 18).

If the head breaks off flush, try using a screw extractor. To do this, center punch the exact center of the remaining portion of the screw or bolt. Drill a small hole in the screw and tap the extractor into the hole. Back the screw out with a wrench on the extractor. See Figure 19.

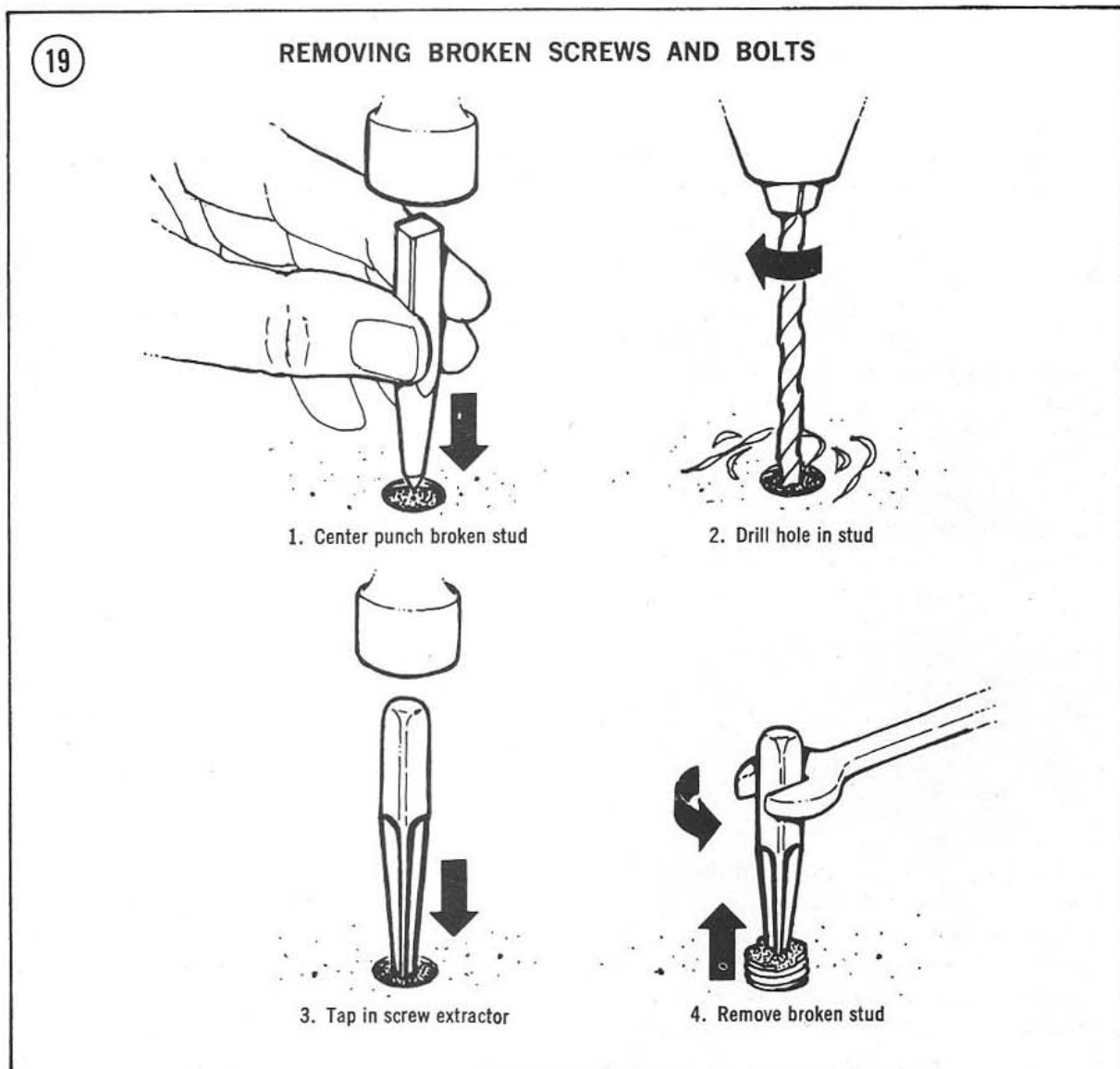

CHAPTER THREE

TUNE-UP, LUBRICATION, AND MAINTENANCE

If this is your first experience with a vehicle that is engine-powered you should become acquainted with products that are available in auto or motorcycle parts and supply stores. Browse around and check out what there is to choose from. Look into the tune-up tools and parts, check out the different lubricants such as 2-stroke motor oil, chain cleaner, and oils and greases. Also check engine degreaser, like Gunk Cycle Degreaser, for cleaning your moped prior to working on it. See what is available to maintain the appearance properly such as polish and wax for the painted surfaces, Armor All for rubber and vinyl and Simichrome for all plated, polished, and stainless parts.

The more you get involved with your moped, the more you will want to work on it. Start out by doing the simple tune-up, lubrication, and maintenance. Tackle more involved jobs as you gain experience so that you will not get frustrated and discouraged.

A moped is a relatively simple machine, but it does require periodic attention to keep it working properly. Without proper attention, you may soon face a number of expensive repairs.

Most expensive repairs can be prevented. A regular program of periodic inspection, lubrication, and maintenance will help find trouble before it becomes major and actually prevent most trouble due to wear.

This chapter explains tune-up, periodic adjustments, maintenance, inspection, and lubrication required on all mopeds.

You can perform all of the procedures in less than one day. Considering the number of care-free, safe, and enjoyable hours of riding possible with a well-maintained moped, maintenance time represents a "bargain" investment.

ENGINE TUNE-UP

The number of definitions of the term "tune-up" is probably equal to the number of people defining it. For purposes of this book, a tune-up is general adjustments and maintenance to ensure peak engine power.

The following paragraphs discuss each facet of a proper tune-up which should be performed in the order given. Unless otherwise specified, the engine should be thoroughly cooled before starting any tune-up service.

Spark Plug

Every 1,000 miles, or sooner if necessary, remove the spark plug. To remove the spark plug, first clean the area around its base to prevent dirt or other material from entering the cylinder. Next, remove the spark plug wire from the top of the spark plug (**Figure 1**) by

pulling straight off. Unscrew the spark plug, using the spark plug wrench furnished with your moped or use a $1\frac{3}{16}$ in. deep socket wrench. If difficulty is encountered removing the spark plug, apply penetrating oil like Liquid Wrench or WD-40 to its base and allow about 20 minutes for the oil to work in.

After removing the spark plug check its condition with those shown in **Figure 2**. If the spark plug has a light tan or gray colored deposit and no abnormal gap wear or electrode erosion is evident, the engine is running properly. Now clean the end that goes into the cylinder head with a wire brush. Inspect it for worn or eroded electrode. These are the 2 points which the spark jumps (**Figure 3**). Replace the spark plug if there is any doubt about its condition. If the spark plug is OK, file the center electrode square, then adjust the gap by bending the outer electrode only with a spark plug gapper tool (**Figure 4**). Measure the gap with a round wire spark plug gauge as shown in **Figure 5**. Do not use a flat gauge as it will indicate an incorrect reading. The proper gap is 0.016 in. (0.4mm).

Before installing the spark plug, clean the seating area on the cylinder head and always use a new gasket. Install the plug only finger tight, then tighten it an additional $\frac{1}{2}$ turn with a spark plug wrench. Wipe off the top tip of the spark plug and install the spark plug wire.

It is a good idea to carry a spare spark plug with you at all times. Keep it in its original package to protect it. The proper spark plug is a Champion L88A, AC 430Z, or NGK B6HS.

Magneto

The engine-mounted magneto generates electricity for the lights and spark plug. It works similar to a generator or alternator on an automobile, but is more compact and is attached directly to the engine.

The stator is stationary and consists of two coils of specially wound wire attached to the engine crankcase. The rotor has built-in permanent magnets which rotate with the engine crankshaft. As the magnets move past the stationary coils they induce a voltage within these coils which powers the lights, horn and spark plug.

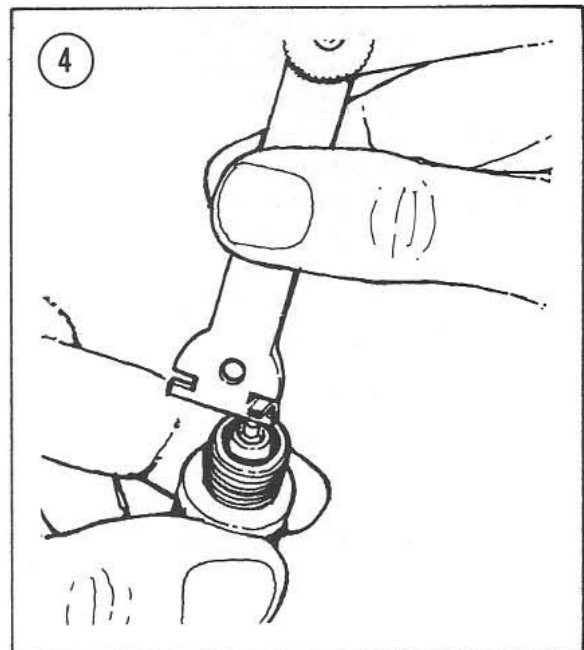
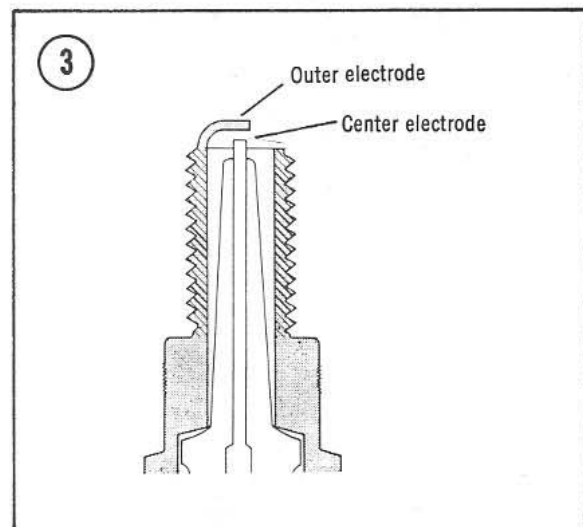
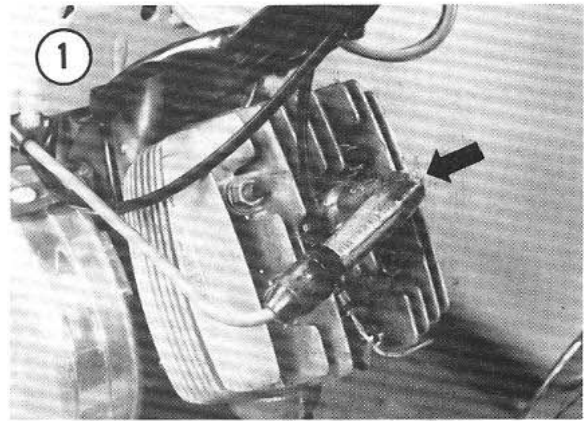

2

SPARK PLUG CONDITIONS

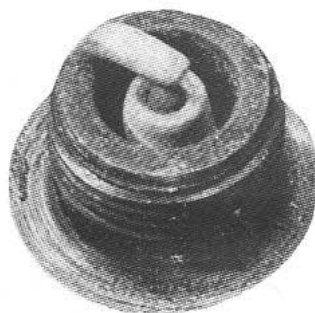

NORMAL USE



OIL FOULED



CARBON FOULED

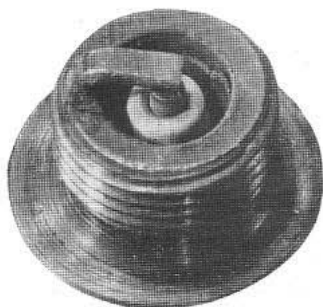

OVERHEATED



GAP BRIDGED

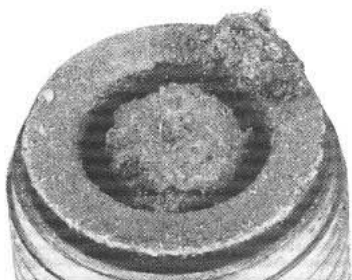

SUSTAINED PREIGNITION



WORN OUT

Photos courtesy of Champion Spark Plug Company.

3

The ignition breaker points, in the magneto, are used to regulate current flow from the ignition coil to the spark plug, at just the right time, when the piston reaches firing position. This is called *Magneto Ignition Timing*. When the breaker points are closed the current is grounded, thus no current to the spark plug. When they open the current that has built up in the coil is no longer grounded and is allowed to flow from the coil directly to the spark plug, bypassing the breaker points. This sudden burst of current jumps the spark plug gap creating the spark for igniting the fuel mixture. To prevent the points from arcing when they open, a condenser is placed in the circuit.

Figure 6 illustrates the typical ignition circuit leading to the spark plug.

Magneto Ignition Timing

For the most accurate setting of magneto timing it is necessary to know the exact position of the piston in the cylinder. This can be measured with a timing tool that screws into the spark plug hole in the cylinder head. It has a rod that goes down into the cylinder and touches the top of the piston. Outside there is a measuring device that indicates how far down the rod has traveled.

There are different types available at quite a wide price range. The one discussed in this procedure is available from a Peugeot dealer for about \$7 (**Figure 7**). The most accurate, but most expensive, is the dial indicator which retails for about \$30. See **Figure 8**. It is also possible to make your own by using an old spark plug, some metal tubing and a sliding rod with 1mm increments scribed onto it (**Figure 9**).

The following procedure is based on the Peugeot No. 69258 Ignition Advance Timing Tool (**Figure 7**). If another type is used, follow the manufacturer's instructions.

1. Remove the 2 screws securing the right-hand engine fairing (**Figure 10**) and remove fairing.
2. Remove the chrome magneto cover by pulling both rubber straps from the nylon lugs on the cover (**Figure 11**).

NOTE: The following procedure requires two people to remove the magneto rotor nut.

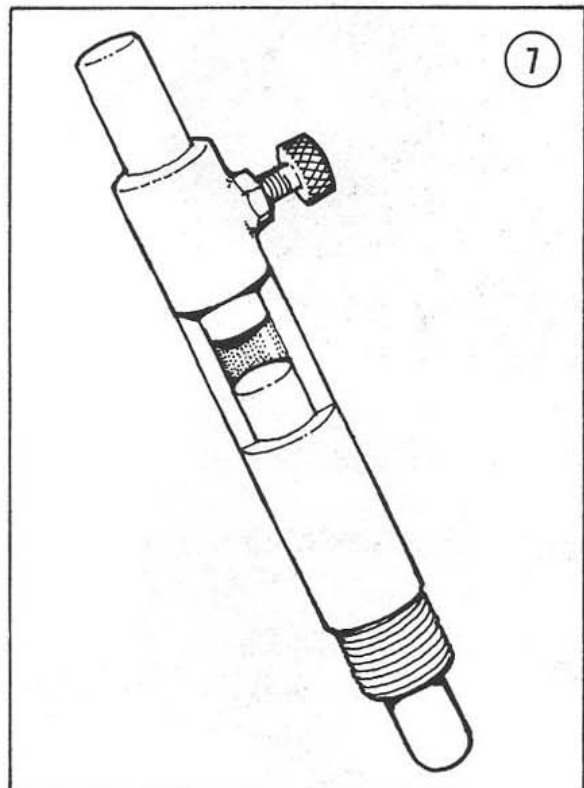
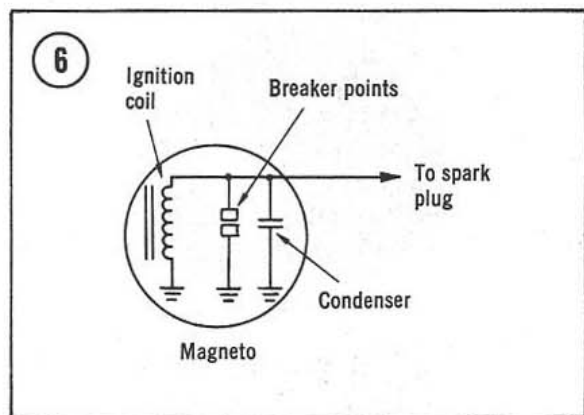
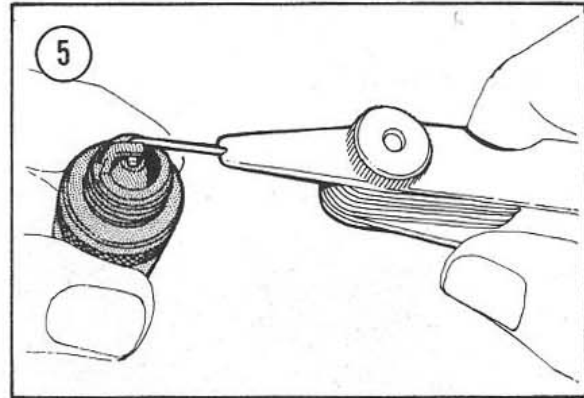

3. Remove the nut securing the rotor with an impact driver. Have your assistant hold the rotor with his hands to prevent it from turning (Figure 12).

4. Remove the rotor with a flywheel puller (Figure 13). Screw the outer body of the puller into the rotor until it stops. Screw the inner

thrust bolt in all the way until it stops. Hold the outer bolt stationary with a 21mm wrench and turn the inner bolt with a 17mm socket or wrench until the rotor disengages from the crankshaft (Figure 14). Slide the rotor out a little; it is not necessary to completely remove it. Remove the flywheel puller.

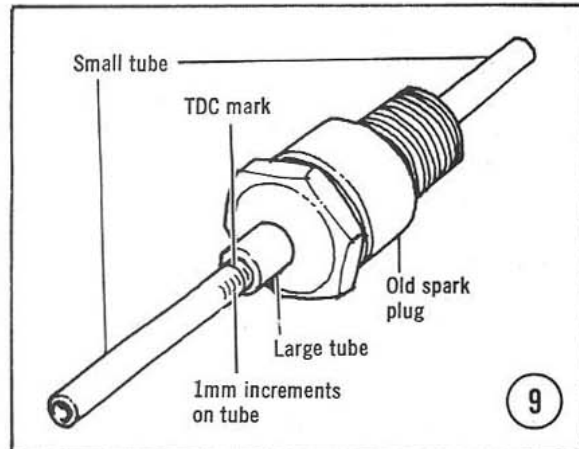
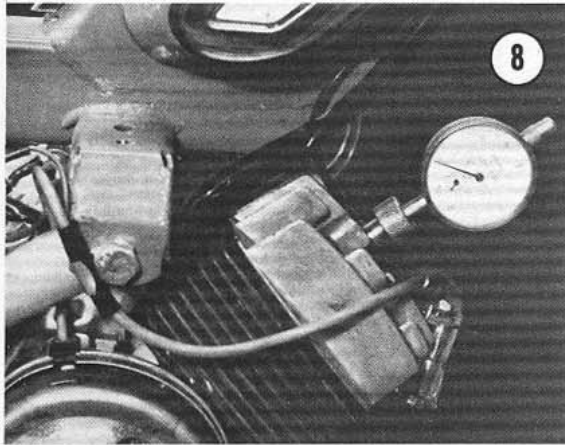

3



5. Clean the area around the spark plug and remove the spark plug. Screw in the timing tool by hand until it is in all the way. It is not necessary to tighten it with a wrench.

6. Find the top dead center of the piston position by rotating the clutch drum in the direction of *normal engine rotation* (arrow on magneto rotor indicates this direction). See **Figure 15**. Loosen the locking screw on top of timing tool and gently press the top and bottom rod down with your finger (**Figure 16**) while rotating the clutch drum. Top dead center is reached when the rod stops its upward travel as the piston has reached the top end of its travel.

7. Tighten the lock screw firmly to lock the upper rod in this position.

8. Rotate the clutch drum in the *opposite direction* and let the lower rod travel down with the piston.

9. Insert a 0.06 in. (1.5mm) feeler gauge between the upper and lower rods (**Figure 17**). Rotate the clutch drum slowly in the *normal direction* until you feel a drag on the feeler gauge when it is moved slightly in and out between the 2 rods. The piston is now in the correct position.

10. Without rotating the crankshaft, turn the rotor in your hands until the timing mark on it aligns with the one on the stator (**Figure 18**). The mark on the stator is the vertical line on the spark plug cable rubber grommet.

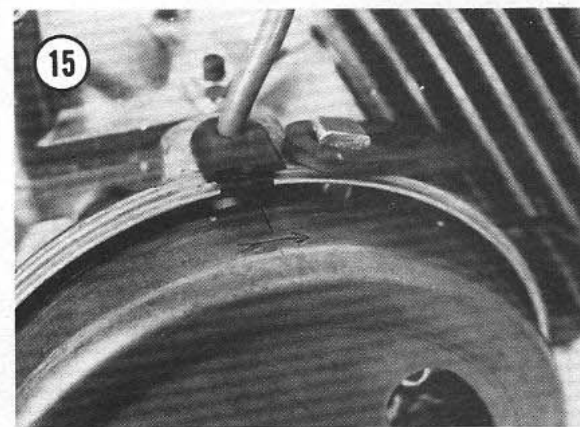
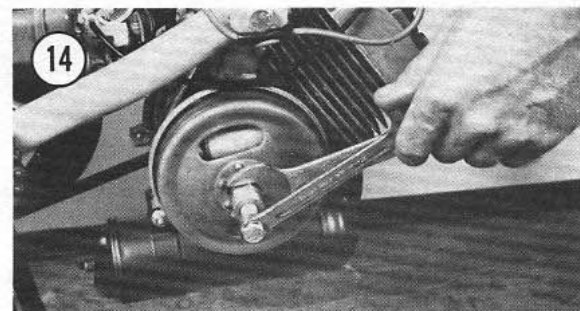
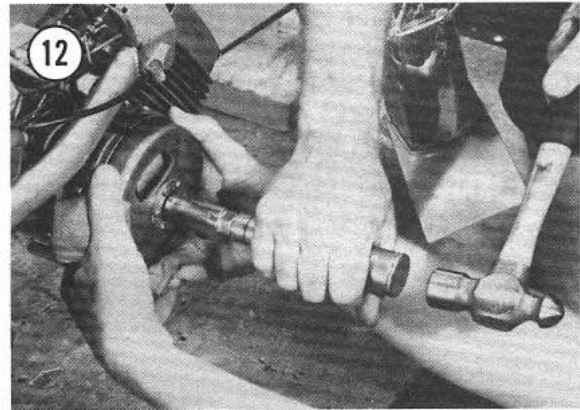
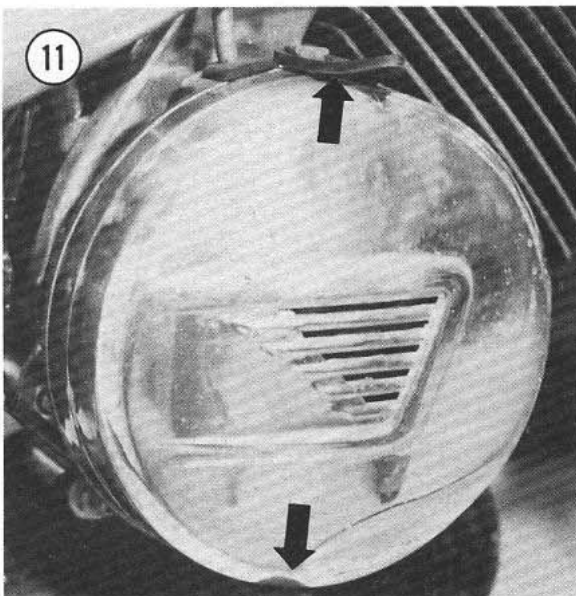

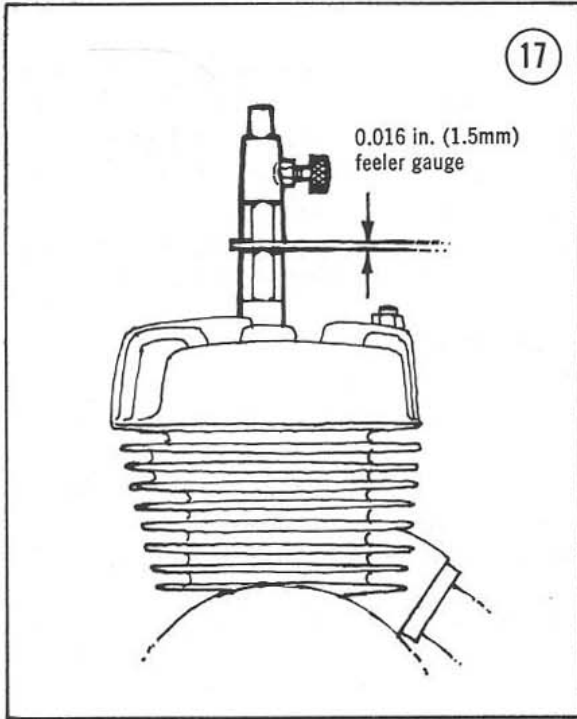
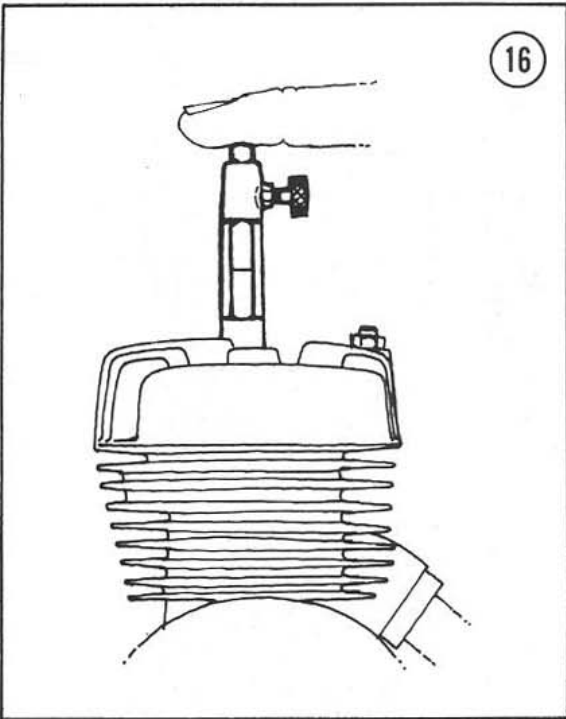

3

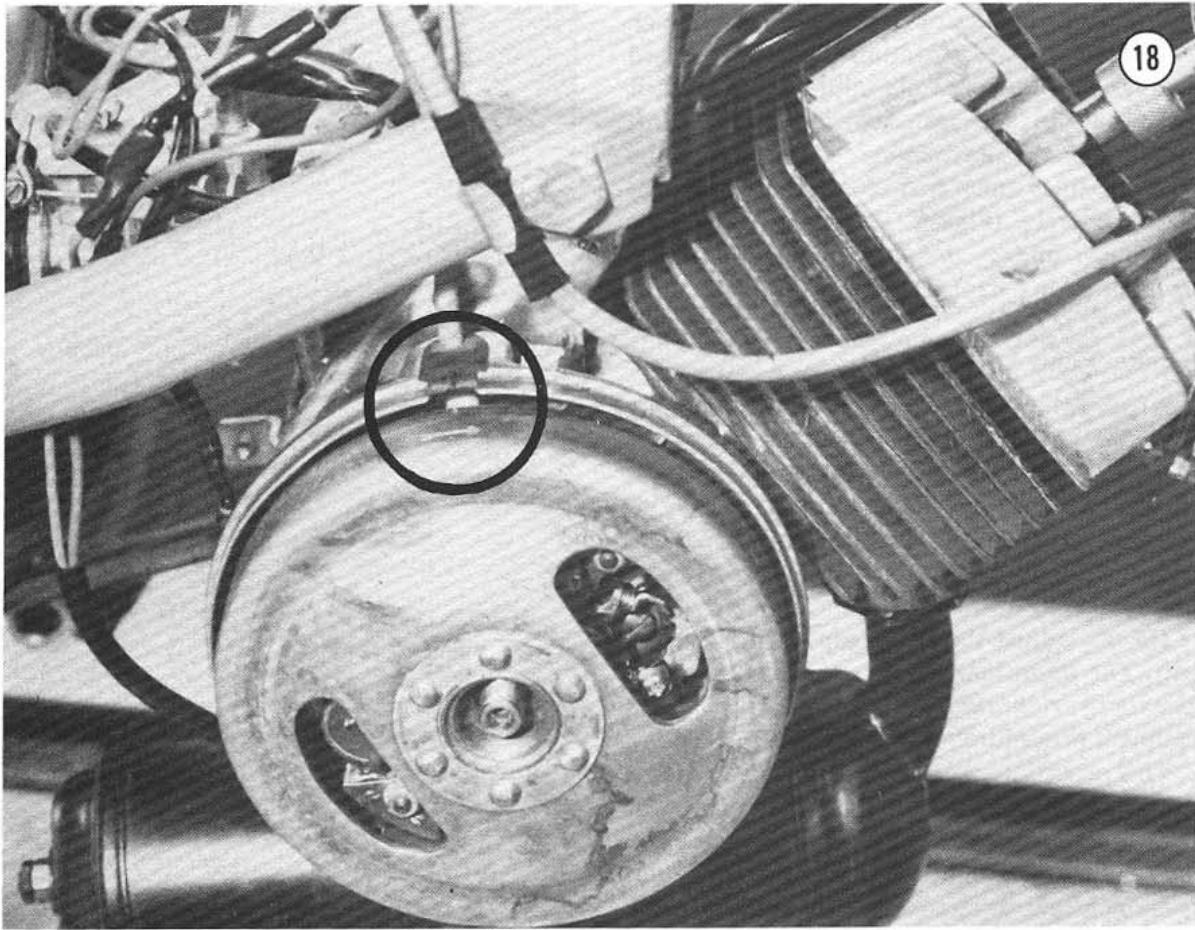

11. Install by reversing Steps 1-3. Be sure to install the rotor nut with the bevel end *in* toward the engine. Use an impact driver (**Figure 12**).

12. Be sure to recheck the setting achieved in Step 9 to make sure the rotor is positioned correctly after the nut is tightened. If it has slipped, repeat the procedure until it is correct.

Breaker Points Inspection and Cleaning

Through normal use the surfaces of the breaker points gradually pit and burn. If they are not too badly pitted, they can be dressed with a few strokes of a clean point file or Flex-Stone (available at any auto parts store). Do not use emery cloth or sandpaper, as particles remain on the points and cause arcing and burning. If a few strokes of the file do not smooth the points completely, replace them.

If points are still serviceable after filing, remove all residue with lacquer thinner. Close the points on a piece of clean white paper, such as a business card. Continue to pull the card through the closed points until no particles or discoloration are transferred to the card. Finally, rotate the engine and observe the points as they open and close. If they do not meet squarely (**Figure 19**) replace them as described under *Breaker Point Removal/Installation* in Chapter Eight.

Breaker Point Adjustment

After adjusting magneto ignition timing (described in this chapter), check the breaker point gap. When breaker point adjustment is correct the point gap will be about 0.016 in. (0.4mm). This gap may vary from 0.012-0.020 in. (0.3-0.5mm) without any performance problems.

Do not adjust the point gap to any specific gap. *The important thing is that they open at exactly the right time* as determined by this adjustment procedure.

This procedure requires a test light. It can be a homemade unit (**Figure 20**) that consists of two "C" or "D" size flashlight batteries and a light bulb, all mounted on a piece of wood, some light gauge electrical wire and 2 alligator clips. These items can be purchased from any hardware store.

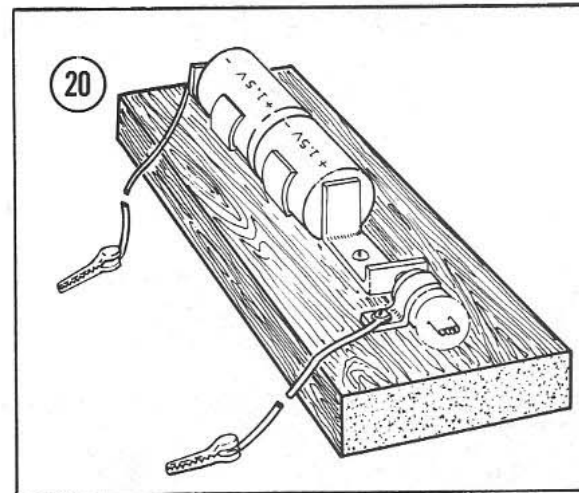
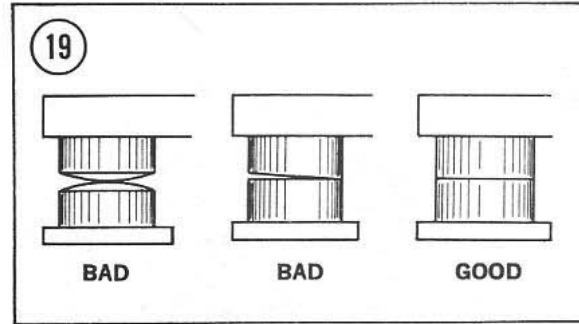

1. Rotate the rotor with your hand until the timing marks of the rotor and stator align (**Figure 18**).
2. Disconnect the brown magneto wire going to the rectifier.

NOTE: *Prior to attaching the tester, check the condition of the batteries by touching the test leads together. The light should be ON. If not, replace the batteries and/or check all connections on the tester. Be sure the tester is operating correctly before using it.*

3. Connect one lead of the test light (**Figure 20**) to a good ground, like one of the cooling fins on the cylinder, and the other to the brown magneto wire disconnected in Step 2. The test light should now be ON. If a commercial tester is used, follow the manufacturer's instructions.

NOTE: *Figure 21 is shown with the magneto rotor removed for clarity, it is not necessary to remove it to perform this adjustment procedure.*

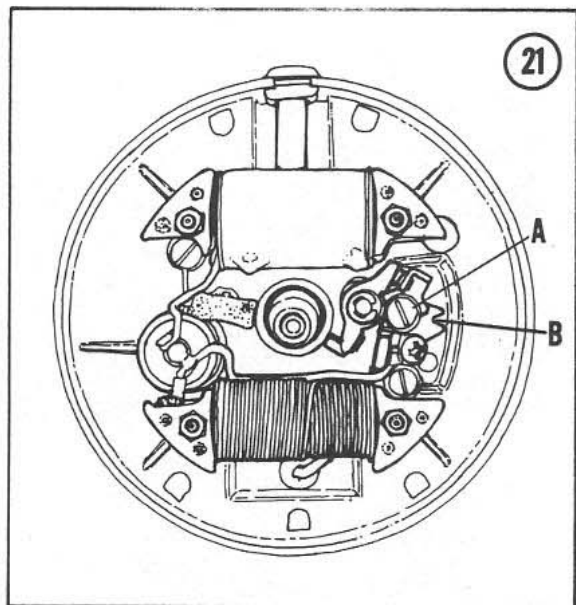

4. Slightly loosen the breaker point attachment screw "A" (Figure 21) and insert a screwdriver between the adjusting notches "B" and turn slightly until the breaker points start to open. The light will dim when the points open, then tighten adjusting screw "A" securely. The points are now adjusted correctly.

5. Disconnect the tester leads and connect the brown magneto wire to the rectifier.

Carburetor

The carburetor on the moped is similar to ones used on outboard motors, power chain saws, lawn mowers, and many motorcycles. Its function is to regulate the amount of air and fuel that is drawn into the engine. As air passes through the carburetor it picks up the right amount of fuel for proper combustion in the engine. As the throttle is opened, by the twist grip on the handlebar, it allows more fuel and air to enter the engine, allowing it to run faster.

Carburetor Idle Adjustment

1. Remove the screws securing the right-hand engine fairing and remove it (Figure 22).
2. Start the engine.
3. With a screwdriver, gently screw in the idle adjustment screw all the way (Figure 23).
4. When the engine has warmed up, slowly loosen the idle adjustment screw to reduce engine speed as much as possible so that the rear wheel does not turn. Speed up the engine a couple of times and let it slow down. Recheck to make sure the rear wheel does not turn.
5. The engine should not stall when coming to a complete stop on the road; if it does, readjust the idle adjustment screw to a higher engine speed.

Carburetor Overhaul

The carburetor should be overhauled every time the engine is decarbonized. Refer to *Carburetor Overhaul* in Chapter Seven.

Air Filter

The air filter should be removed and cleaned every 4,000 miles. Refer to *Air Filter Removal/Installation* in Chapter Seven.

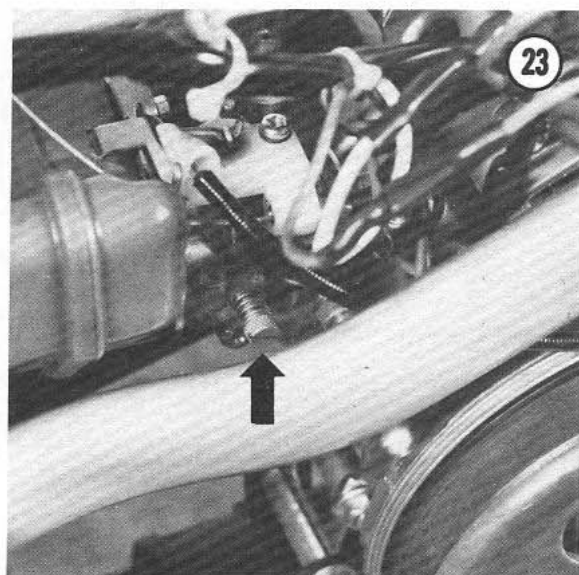
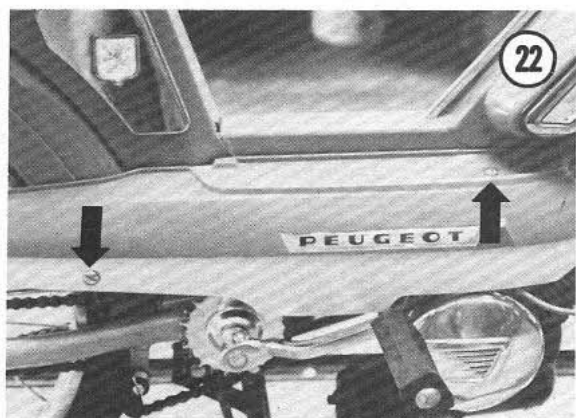

Decarbonizing

Every 4,000 miles the carbon deposits should be removed from the piston, cylinder head, and muffler. If it is not cleaned off, it will cause preignition (ping), overheating, and high fuel consumption.

Engine Decarbonizing:

1. Remove the cylinder head as described under *Cylinder Head Removal/Installation* in Chapter Five.
2. Gently scrape off carbon deposits from top of piston (**Figure 24**) and cylinder head (**Figure 25**) with a dull screwdriver. Do not scratch the surfaces.
3. Wipe the surfaces clean with a cloth dipped in cleaning solvent.
4. Clean out the decompressor exhaust port in the cylinder using a thin screwdriver and a large pipe cleaner. This port extends from the top of the cylinder to the exhaust port (**Figure 26**).
5. Remove the spark plug, clean and regap to 0.016 in. (0.4mm).
6. Install head by reversing the removal steps.

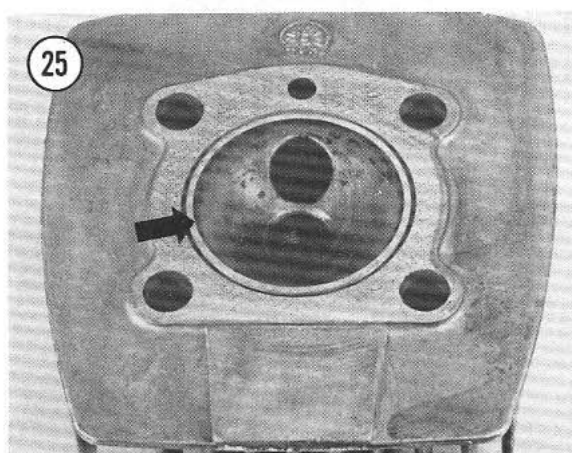
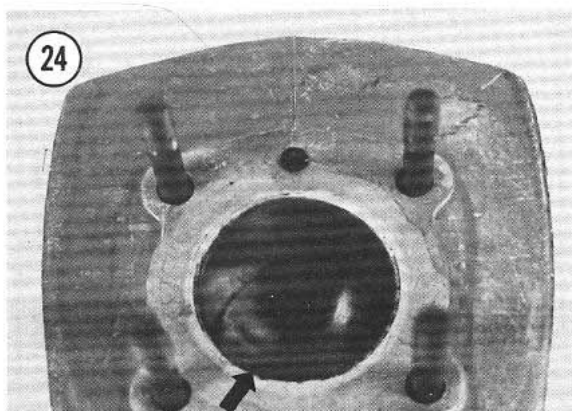

Muffler Decarbonizing:

1. Remove the muffler by unscrewing the fitting (**Figure 27**) securing the muffler to the cylinder.
2. Remove the bolt, lockwasher and nut securing the muffler to the frame mounting bracket (**Figure 28**) and remove the muffler.
3. Remove the locknut and nut from the rear cap of the muffler (**Figure 29**).
4. Remove the rear cap and inner disc with tube (**Figure 30**).
5. Scrape carbon from all accessible areas with a screwdriver blade.
6. Run a round, wire brush or old toothbrush into the inner tubes and the curved outlet tube.
7. Blow out all loose carbon deposits with compressed air.
8. Inspect the body and outlet tube to make sure there are no dents or cracks. Straighten out if possible or replace.
9. Assemble by reversing the disassembly steps.

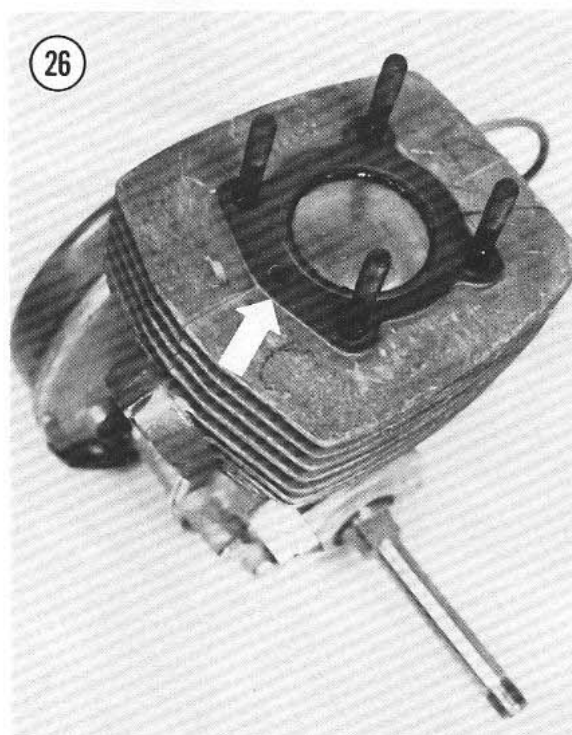

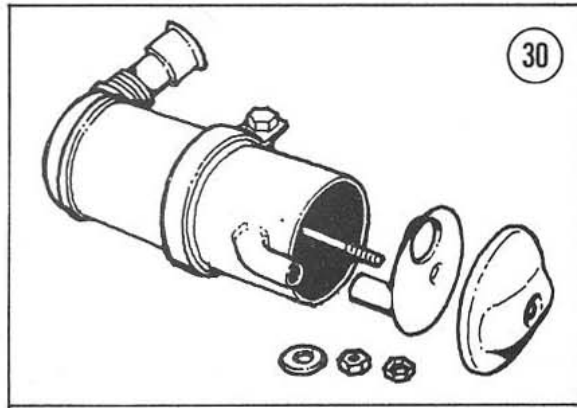
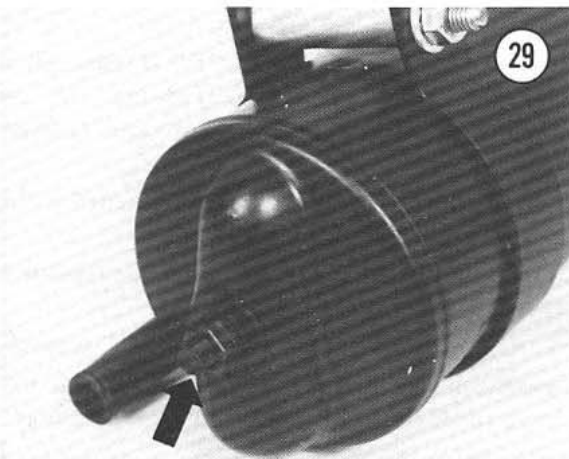
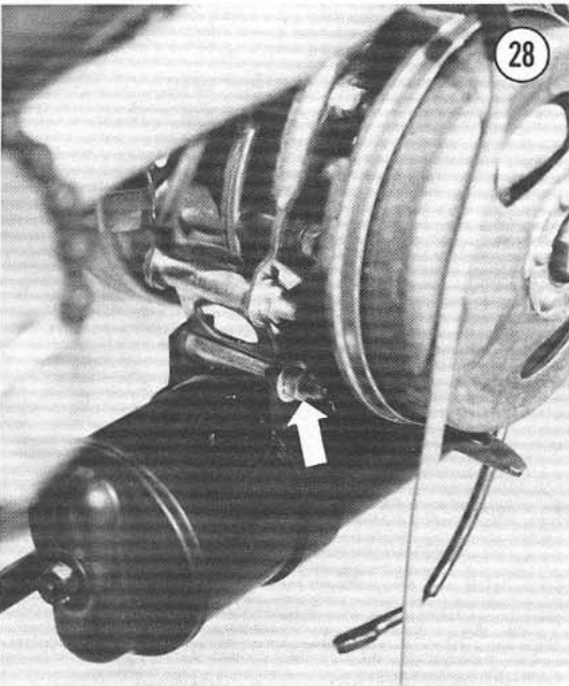
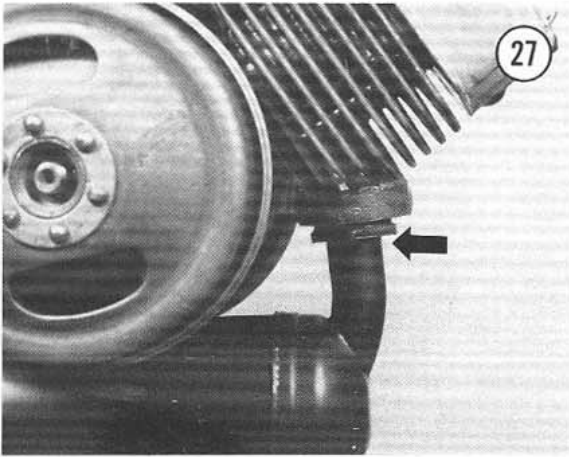

3

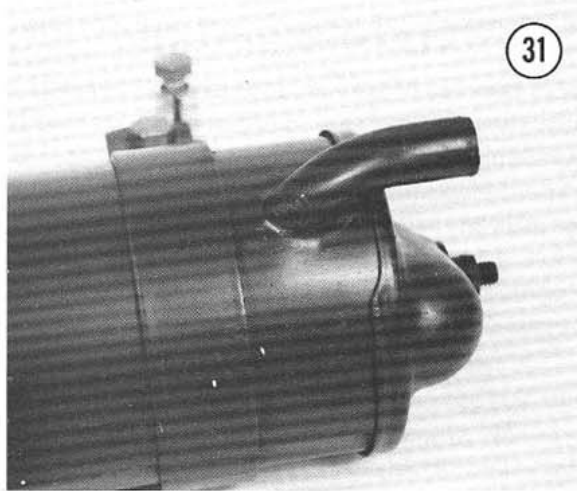
**CAUTION**

Be sure to replace the end cap with the cutout portion of flange aligned with the outlet tube. (Figure 31).

10. Install the muffler using a new ring gasket.

LUBRICANTS**Oil**

Oil is graded according to its viscosity, which is an indication of how thick it is. The Society of Automotive Engineers (SAE) system distinguishes oil viscosity by numbers, called "weights". Thick (heavy) oils have higher viscosity numbers than thin (light) oils. For example, a 5-weight (SAE 5) oil is a light oil while a 90-weight (SAE 90) oil is relatively heavy. The viscosity of an oil has nothing to do with its lubricating properties.

In this manual, many procedures specify light oil. This means a SAE 5 oil or equivalent.

Grease

Molybdenum disulphide grease is preferable as a lubricant for many parts of a moped. Water does not wash grease off parts as easily as it washes off oil. In addition, grease maintains its lubricating qualities better than oil over long distances. In a pinch, though, the wrong lubricant is better than none at all. Correct the situation as soon as possible.

A number of procedures in this manual specify thin grease. Lubriplate, a white grease, is highly satisfactory for mopeds and comes in a small tube for easy application.

CLEANING SOLVENTS

A number of solvents can be used to remove old dirt, grease, and oil. Kerosene is readily available and comparatively inexpensive. Another inexpensive solvent similar to kerosene is ordinary diesel fuel. Both of these solvents have a very high temperature flash point and can be used safely on any adequately ventilated area away from open flames.

WARNING

Never use gasoline. Gasoline is extremely volatile and contains tremendously destructive potential energy. The slightest spark from metal parts accidentally hitting, or a tool slipping, could cause a fatal explosion.

PERIODIC LUBRICATION

Front and Rear Wheel Hubs

Every 6,000 miles, completely disassemble, clean, inspect, lubricate, and reassemble the hubs as described under *Front and Rear Hubs Removal/Installation/Inspection* in Chapter Ten.

Front and Rear Brake Cams

Every 6,000 miles, remove the front and rear wheels. Remove brake plate assemblies and lubricate cams and pivot pins as described under *Brake Lining Removal/Installation* in Chapter Nine.

Cables

Every 600 miles, squirt a few drops of light oil on the brake, choke lever, and decompressor

control lever cables where they enter the cable housings.

Chains

Every month (more often in dusty areas), remove the chains. Clean and lubricate them as described under *Chain Cleaning and Lubrication* in Chapter Six.

Headset (Fork Bearings)

Every 6,000 miles, remove the upper and lower headset bearings. Clean, inspect, and lubricate them as described under *Headset Removal/Installation/Inspection* in Chapter Ten.

Pedals

Every month, squirt a few drops of 30 weight oil at the point where the pedal attaches to the crank arm.

PERIODIC MAINTENANCE

Drive Chain Adjustment

Every 2,000 miles the drive chain should be adjusted. Proper chain tension is important. If the tension is too loose, the chain may skip while traveling at high speed. If tension is too tight, pedaling, engine effort, and chain wear increase.

The correct chain tension is measured by pressing up on the bottom of the chain at midpoint. The slack should be $\frac{1}{2}$ in. (12.5mm). See **Figure 32**. If the tension is incorrect, use the following adjustment procedure.

1. Loosen the rear axle locknuts "A" (**Figure 33**).
2. Turn the adjusting nuts "B" (**Figure 33**) an equal number of turns: Turning the nut *clockwise* will increase tension and *counterclockwise* will decrease tension.
3. Check to see that the wheel is aligned within the center of the chainstays.
4. Rotate the wheel to make sure the tension in the chain is constant.
5. Tighten the rear axle locknuts "A" securely.
6. Check the rear brake operation as it may have to be adjusted. Refer to *Rear Brake Adjustment* in Chapter Nine.

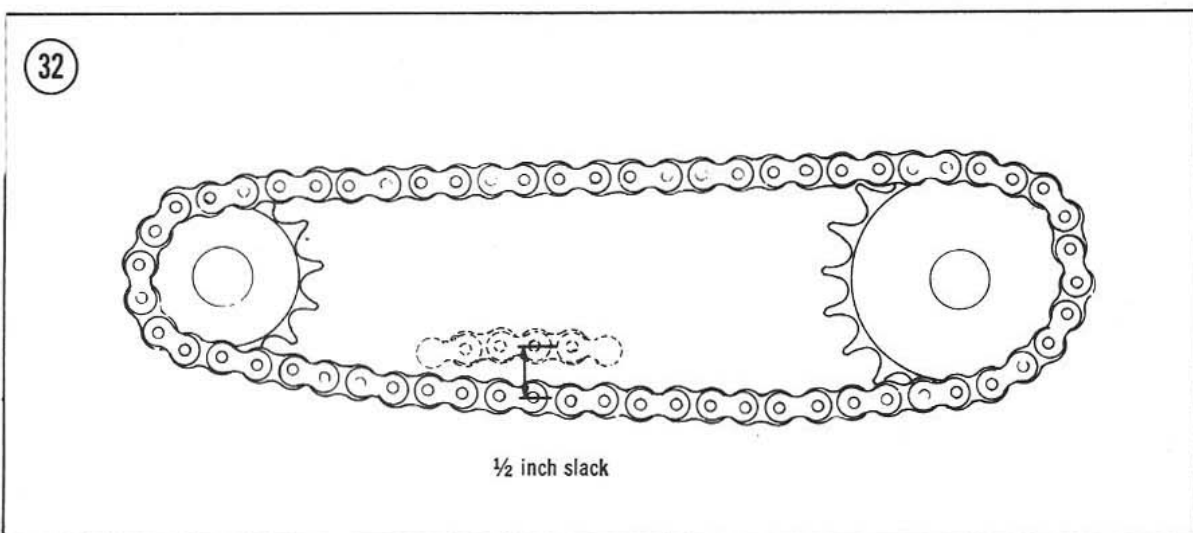
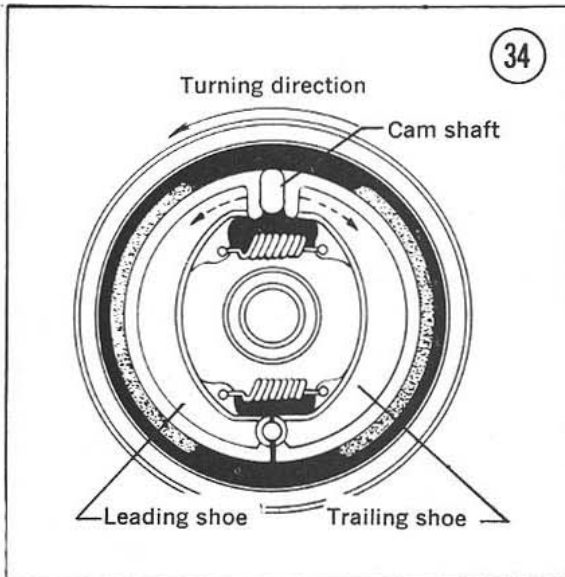
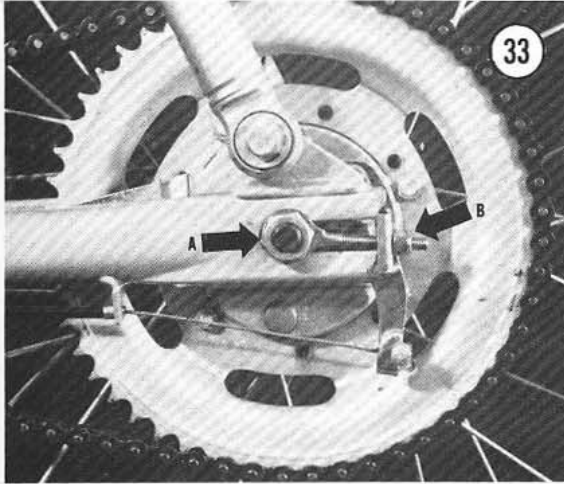

Bicycle Chain Adjustment

No adjustment is necessary due to the automatic chain tensioner (similar to a bicycle derailleur).

Drive Belt Adjustment

No adjustment is necessary to the drive belt. The engine mounting spring maintains the proper tension at all times.

Brake Adjustment

Figure 34 illustrates the major parts of the brakes. Operation of the brake lever rotates the cam, which in turn forces the brake shoes out to contact the brake drum.

Every 500 miles, adjust the front and rear brake lever free play. Free play is the distance the brake lever travels between the released position and the point when the brake shoes come in contact with the drums. Free play increases when the cables stretch with age.

1. Adjust free play by loosening locknut "A" and turn the adjusting barrel "B" clockwise to reduce the slack in the cable (Figure 35).
2. If the cable has stretched so much that this adjustment is not enough, adjustment will have to be performed at the brake arm. Screw the adjusting barrel all the way in toward the hand grip.
3. At the wheel, remove the cable and anchor bolt from the brake arm by pushing on the arm and slipping the bolt and cable out (Figure 36).

4. Mark the *lower* anchor bolt position of the cable with a piece of masking tape. Loosen the bolt and slip it *up* the cable about $\frac{1}{4}$ to $\frac{1}{2}$ inch and tighten the bolt.
5. Reinstall the cable and anchor bolt in brake arm and retest.
6. Repeat Step 4 if necessary.

Front Forks

Every 4,000 miles, disassemble, clean, and lubricate the front forks as described under *Front Fork Disassembly/Assembly* in Chapter Ten.

Wheels and Tires

Every 400 miles, check the wheels for bent or damaged rims and loose or missing spokes. Check tires for any road damage or worn tread. Refer to Chapter Ten for complete wheel information.

Spokes

Spokes should be checked periodically for looseness or bending. Check spokes for proper tension. The “tuning fork” method for checking tension is simple and works well. Tap each spoke with a spoke wrench or screwdriver shank. A taut spoke will emit a clear, ringing tone; a loose spoke will sound flat. All spokes in a correctly tightened wheel will emit tones of similar pitch, but not necessarily the same tone.

Bent, stripped, or otherwise damaged spokes should be replaced as soon as they are detected. Unscrew the nipple from the spoke at the rim, then push the nipple far enough into the rim to free the end of the spoke, taking care not to push the spoke all the way in. Remove the defective spoke from the hub, then use it to match a new one of the same length. Install by reversing the removal steps. Check the new spoke periodically; as it will stretch and must be retightened several times until it takes its final set.

Spokes tend to loosen as the moped is used. Retighten each spoke one turn, beginning with those on one side of the hub, then those on the other side. Tighten the spokes of a new moped after the first 50 miles of operation and then at 50 mile intervals until they no longer loosen.

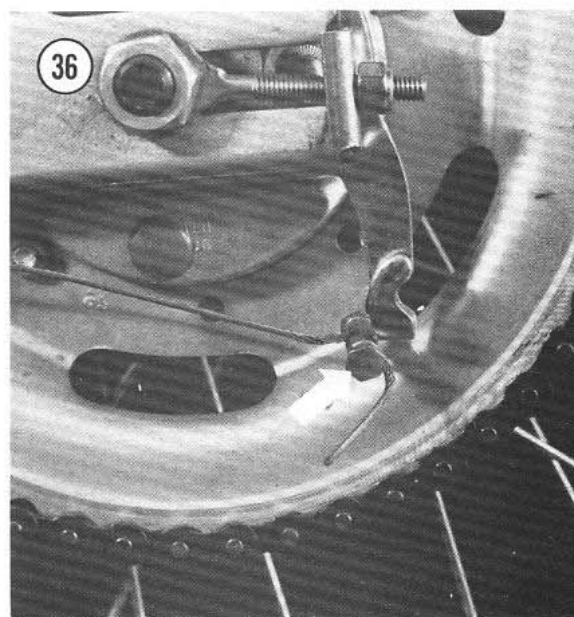
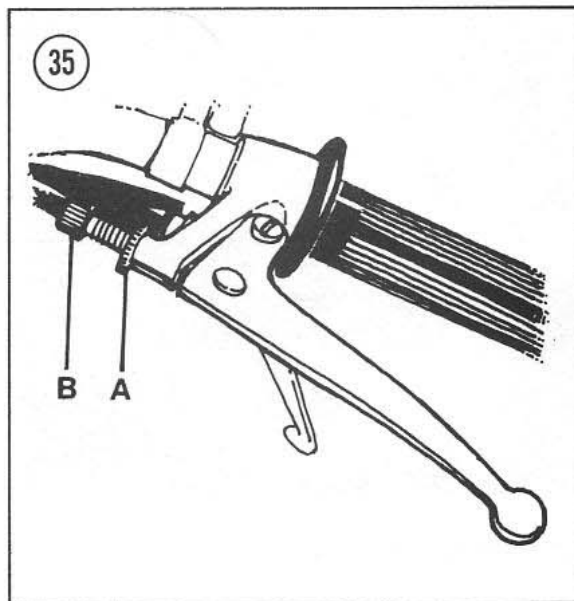

Drive Pulley

Every 6,000 miles, the drive pulley should be lubricated with multipurpose grease. The grease fitting (Figure 37) requires the use of a small grease gun. These are available from most motorcycle or automotive supply stores for about \$5.

Fasteners

Every 1,000 miles, check all nuts, screws, and bolts that secure parts to the frame, e.g. engine

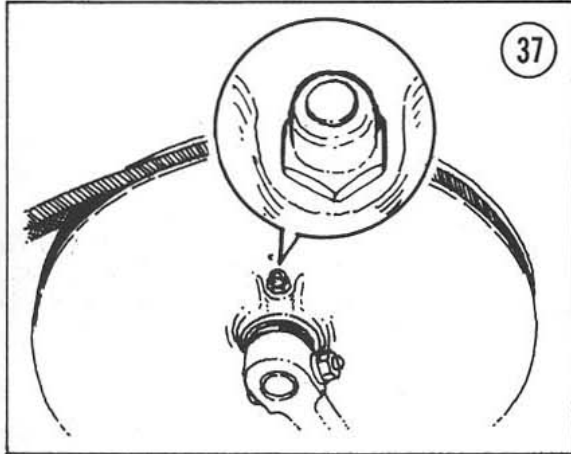

fairings, lights, fenders, etc. to make sure that they are tight.

Extended Storage

If you store the moped for an extended period of time, prepare your moped in the following way:

- a. Empty the fuel tank completely.

- b. Run the engine until the carburetor is empty.
- c. Remove the spark plug and put a few drops of oil into the cylinder.
- d. Turn the engine over by pedaling to spread the oil around in the cylinder.
- e. Install the spark plug, only finger-tight and connect the spark plug wire.
- f. Clean and lubricate all parts.
- g. Dampen a cloth with light weight oil and wipe all metal parts or spray them with a light coat of WD-40. This will help protect against rust.
- h. Cover the moped with a tarp or blanket.

After Storage

Before starting the engine after storage, remove the spark plug and squirt a small amount of fuel into the cylinder to help remove the oil coating. Install the spark plug, but do not connect the spark plug wire. Pedal the engine over a few times, then reconnect the spark plug wire and start the engine.

CHAPTER FOUR

TROUBLESHOOTING

Diagnosing mechanical problems is relatively simple if you use orderly procedures and keep a few basic principles in mind.

The troubleshooting procedures in this chapter analyze typical symptoms, and show logical methods of isolating causes. These are not the only methods. There may be several ways to solve a problem, but only a systematic, methodical approach can guarantee success.

Never assume anything. Do not overlook the obvious. If you are riding along and the moped suddenly quits, check the easiest, most accessible problem spots first. Is there gasoline in the tank? Is the fuel shutoff valve in the ON or RESERVE position? Has the spark plug wire fallen off? Check the ignition switch to make sure it is in the RUN position.

If nothing obvious turns up in a quick check, look a little further. Learning to recognize and describe symptoms will make repairs easier for you or a mechanic at the shop. Describe problems accurately and fully. Saying that "it won't run" isn't the same as saying "it quit on the road at low speed and won't start," or that "it sat in my garage for three months and then wouldn't start."

Gather as many symptoms together as possible to aid in diagnosis. Note whether the engine lost power gradually or all at once, what color

smoke (if any) came from the exhaust, and so on. Remember that the more complicated a machine is, the easier it is to troubleshoot because symptoms point to specific problems.

After the symptoms are defined, areas which could cause the problems are tested and analyzed. Guessing at the cause of the problem may provide the solution, but it can easily lead to frustration, wasted time, and a series of expensive, unnecessary parts replacement.

You do not need fancy equipment or complicated test gear to determine whether repairs can be attempted at home. A few simple checks could save a large repair bill and time lost while the moped is in a dealer's service department. On the other hand, be realistic and do not attempt repairs beyond your abilities. Service departments tend to charge heavily for putting together a disassembled engine that may have been abused. Some won't even take on such a job — so use common sense, don't get in over your head.

OPERATING REQUIREMENTS

An engine needs three basics to run properly: correct fuel/air mixture, compression, and a spark at the right time. If one or more are missing, the engine won't run. The electrical system

is the weakest link of the three basics. More problems result from electrical breakdowns than from any other sources. Keep that in mind before you begin tampering with carburetor adjustment and the like.

If a moped has been sitting for any length of time and refuses to start, check and clean the spark plug and then look to the gasoline delivery system. This includes the tank cap, tank, fuel shutoff valve, lines, and the carburetor. Rust may have formed in the tank, obstructing fuel flow. Gasoline deposits may have gummed up the carburetor jet and air passages. Gasoline tends to lose its potency after standing for long periods. Condensation may contaminate it with water. Drain old gas and try starting with fresh gasoline; don't forget to add the proper amount of 2-stroke oil.

EMERGENCY TROUBLESHOOTING

When the moped is difficult to start or won't start at all, it does not help to continue kicking the pedal down or kick the tires. Check the obvious problems even before getting out your tools. Go down the following list step-by-step. Do each one; you may be embarrassed to find your cutoff switch in the OFF position, but that is better than wearing out your legs trying to get it started. If the moped still won't start, refer to the appropriate troubleshooting procedures which follow in this chapter.

1. Is there fuel in the tank? Remove the filler cap and rock the moped, listen for the fuel sloshing around.

WARNING

Do not use an open flame to check in the tank. A serious explosion is certain to result.

2. Is the fuel shutoff valve in the ON position? Turn it to RESERVE to be sure that you get the last remaining gas.

3. Is the choke in the right position? That is, squeezed in for a cold engine and released for a warm engine.

4. Is the engine cutoff switch in the ON position?

5. Is the decompressor valve loose?

ENGINE

Starting Problems

Check first to see if there is sufficient gas. Open the gas cap and check for gas in the tank by rocking the moped and listening for the gas to slosh around. If gas is present in the tank remove the fuel line from the carburetor and see if the gas is flowing through the line. If not, check the fuel shutoff valve to make sure it is in the ON or RESERVE position. With the fuel shutoff valve in the ON position and still no gas is present there may be dirt or foreign matter in the fuel line or it may be kinked.

There also may be water in the fuel or the jet in the carburetor may be clogged. Check to see that the air holes in the fuel cap are not plugged (**Figure 1**) and that the fuel shutoff valve filter is clean (**Figure 2**). Don't forget to use the choke in trying to start a cold engine. If there is sufficient fuel to the carburetor, next check out the electrical system.

4

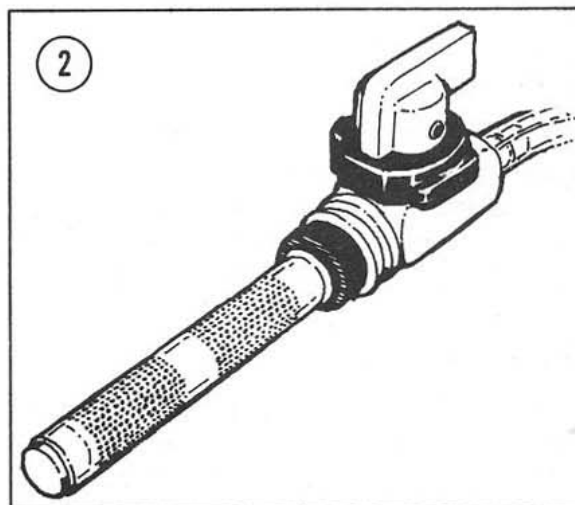
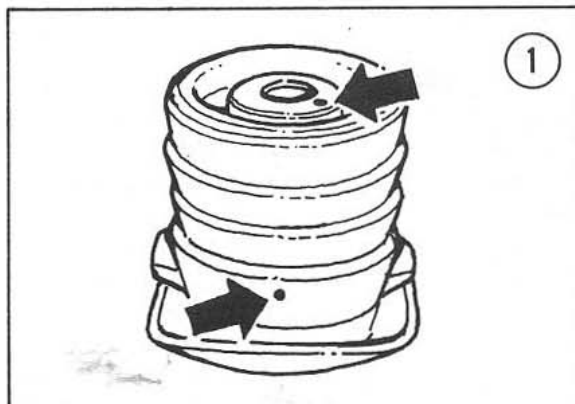

Check that the ignition switch is in the ON position and that the spark plug wire is on tight. If both are OK, remove the spark plug and inspect it, either clean and regap or replace it with a new one. Connect the spark plug wire to the spark plug, and lay the spark plug on the cylinder head; make sure that the base of the plug makes good contact. Kick the pedal as though you were trying to start the moped; there should be a big bright blue spark at the tip of the electrode. If there isn't a spark or if the spark is small, then there is an electrical problem.

Check that the spark plug wire is not broken, frayed or has a loose connection at the spark plug or magneto. If these seem to be alright, then check the magneto. The timing may be off, the contacts dirty, the condenser worn out, or the wire grounded, or the ignition coil may be shorted or open. If any of these problems are evident, refer to Chapter Eight, *Electrical* for procedures and adjustments.

If there is a good healthy spark and fuel to the carburetor, check to make sure the air cleaner is clean and that the carburetor jet is clean. Make sure that the intake manifold nuts are tight and the carburetor clamp to the intake manifold is tight. Check that the gasket between the carburetor and intake manifold is not broken or cracked, replace if necessary.

Make sure the decompressor valve is tight in the cylinder head. Check that the belt is not slipping on the drive pulley when kick starting and that the drive knob is on the right position. The correct position is toward the outside of the drive pulley (**Figure 3**).

Rough Idle

Rough idle is probably caused by incorrect ignition timing, carburetor adjustment, a clogged muffler, loose decompressor valve or a vacuum leak from loose connections at the carburetor. Check gas cap for plugged air holes.

Power Loss

The ignition system may have a defective spark plug, ignition coil or condenser or the timing may be off. The carburetor may be dirty, misadjusted or may have a dirty air filter.

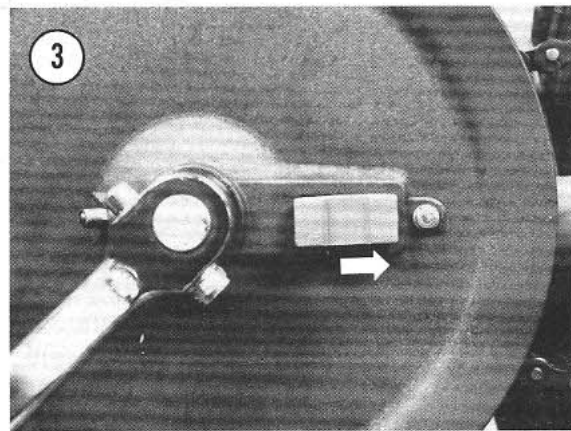

The engine may have worn piston rings, a damaged cylinder, or it may need decarbonization. The muffler opening may be clogged by mud or it may need to be decarbonized. Check also for improper chain tension and/or slipping drive belt.

Misfires

This is usually caused by a weak or fouled spark plug or a breakdown of the spark plug wire. Check to see if a spark “jumps” out from the plug wire to any part of the frame before it gets to the plug. This is best done at night or in a dark garage.

Smoking or Sputtering

This is usually caused by insufficient burning of the fuel or an improper gasoline/oil mixture. Check for a fouled spark plug, clogged muffler, or air cleaner or too much oil in the fuel mixture.

Overheating

This can be caused by too high of a spark plug heat range, the percentage of oil in fuel mixture too low, clogged or dirty cooling fins on the engine cylinder and cylinder head, incorrect ignition timing, or carbonized engine or muffler. Also check for dragging brakes, slipping clutch, or drive chain that needs oil or is adjusted too tight.

Piston and Engine Seizure

Piston seizure is caused by improper piston to cylinder clearance, broken piston rings, or

insufficient oil in the fuel/oil mixture. Engine seizure may be caused by a seized piston, broken or seized crankshaft bearings, broken intake valve, smashed flywheel magneto cover, buckled magneto, or a magneto stator screw caught between coil and rotor.

Backfiring

Ignition timing incorrect, engine too cold, defective spark plug, or contaminated fuel may be the cause of backfiring. Also, check for heavy carbon buildup on the piston and cylinder head.

Engine Noises

Abnormal engine noises are very difficult to describe and diagnose. Knocking may indicate a loose crankshaft assembly caused by bad bearings or a loose or broken engine to frame bracket. Also, the clutch drum may be loose on the crankshaft. A slapping noise usually comes from a loose piston. A slamming noise may be caused by an unriveted flywheel magneto cam, damaged cylinder caused by overheating, or faulty clutch parts. A rubbing noise may be from the flywheel magneto rotor being bent or out of true, or the cover and rotor touching each other. Pinging is caused by improper ignition timing or gasoline octane rating too low. If pinging occurs, it should be corrected immediately as it will cause piston damage. A whistling noise may come from a defective crankcase seal, loose or damaged bearings, air leaking around the carburetor, or intake manifold or magneto breaker cam needing lubrication.

Engine Vibration

Check to see if the engine mounting bracket is loose or broken. Vibration may be caused by worn engine and clutch bearings, an unbalanced rotor in the magneto, or damaged counterweights in the clutch variable drive unit.

CLUTCH

Slippage or Dragging

Clutch slippage may be due to oil or grease on the linings. Dragging may be due to a warped or defective clutch pressure plate spring or broken clutch shoe return springs. It may also be caused by the engine idle being set too high.

BRAKES

Loss of braking power is due to worn out linings or improper cable adjustment. If brakes grab, there is probably oil or grease on the linings and they will have to be replaced. If they stick, the return springs may be weak or broken, the pivot cams may need lubrication or the cables need adjusting. Brake grabbing may also be caused by out-of-round drums or broken or glazed brake shoes.

ELECTRICAL

Lighting and Horn

Dimness of lights is usually caused by a loose bulb in the socket, corroded bulb contacts, loose or corroded electrical terminal connections, incorrect bulb size, bare wires which will short out or an improperly working magneto.

Check the horn for loose or corroded electrical connections.

Be sure to thoroughly check all electrical and ground connections before replacing light bulb or horn.

SUSPENSION

Hard steering may be caused by improper tire inflation, improper adjustment, or lack of lubrication of the steering head bearings. Wheel shimmy or vibration is caused by misaligned wheels, loose or broken spokes, or worn wheel bearings. Poor handling may be caused by worn shock absorbers, or the front forks needing lubrication, or damaged frame and rear swing arm.

CHAPTER FIVE

ENGINE

The engine in the moped is a single cylinder, 2-stroke-piston port, air-cooled unit with a displacement of 3.05 cu. in. (50cc). This chapter contains information for removal, inspection, service, and reassembly of the engine. The majority of the work can be accomplished without removing the entire engine from the frame, with the exception of a complete overhaul.

ENGINE PRINCIPLES

Figure 1 explains how the engine works. This will be helpful when troubleshooting or repairing your engine.

ENGINE LUBRICATION

Lubrication for the engine is provided by the fuel/oil mixture used to power the engine. There is no oil supply in the crankcase as it would be drawn into the cylinder causing the spark plug to foul. There is sufficient oil in the fuel/oil mixture to lubricate the engine bearings as it is drawn into the crankcase. The proper fuel/oil mixture is 50 parts of *unleaded gasoline* to one part *2-stroke motor oil*.

ENGINE COOLING

Cooling is provided by air passing over the cooling fins on the engine cylinder head and

cylinder. Therefore it is very important to keep these fins free from a buildup of dirt; oil, grease, and other foreign matter. Brush out the fins with a whisk broom or small stiff paintbrush.

CAUTION

Remember, these fins are thin, in order to dissipate heat, and may be damaged if struck hard.

ENGINE REMOVAL/INSTALLATION

Prior to removal or disassembly of any major part of the engine, clean the entire area of all dirt, oil, grease, and other foreign matter. Use a cleaner designed specifically for this purpose like Gunk Cycle Degreaser. Follow the manufacturer's directions and avoid using too high of a water pressure when rinsing off the engine. Keep water and dirt from entering into the clutch and brake areas.

It is a good practice to keep the engine and surrounding area clean at all times, this will aid engine cooling and help keep the engine running at proper temperature at all times.

Make sure your work area is clean; you should have a work bench or flat area to place the disassembled parts. Place them in the order that they are removed; this will help when reassembling the parts.

2-STROKE OPERATING PRINCIPLES

The crankshaft in this discussion is rotating in a counterclockwise direction.

As the piston travels downward, it uncovers the exhaust port (A) allowing the exhaust gases, that are under pressure, to leave the cylinder. A fresh fuel/air charge, which has been compressed slightly, travels from the crankcase into the cylinder through the transfer port (B). Since this charge enters under pressure, it also helps to push out the exhaust gases.

While the crankshaft continues to rotate, the piston moves upward, covering the transfer (B) and exhaust (A) ports. The piston is now compressing the new fuel/air mixture and creating a low pressure area in the crankcase at the same time. As the piston continues to travel, it uncovers the intake port (C). A fresh fuel/air charge, from the carburetor (D), is drawn into the crankcase through the intake port, because of the low pressure within it.

Now, as the piston almost reaches the top of its travel, the spark plug fires, thus igniting the compressed fuel/air mixture. The piston continues to top dead center (TDC) and is pushed downward by the expanding gases.

As the piston travels down, the exhaust gases leave the cylinder and the complete cycle starts all over again.

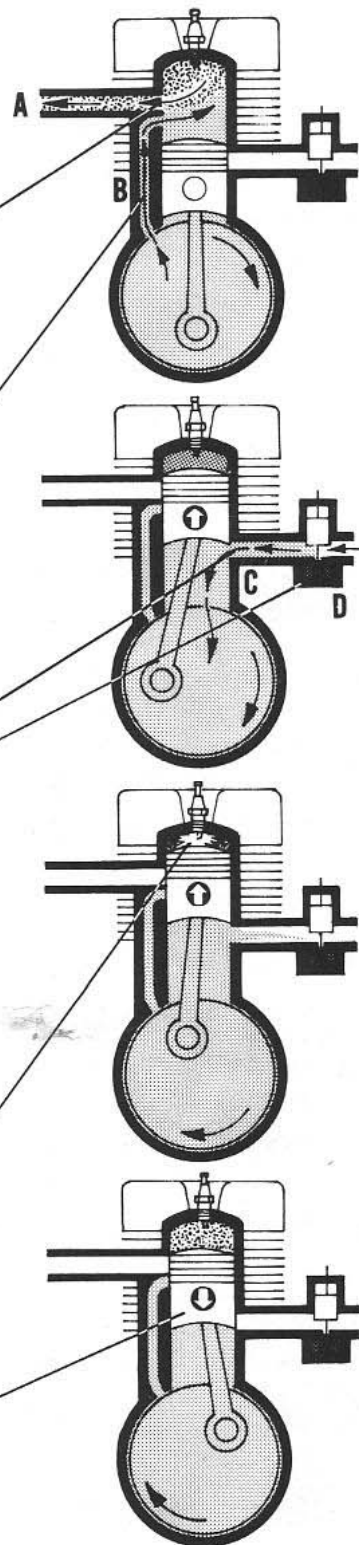

①

5

1. Place the moped on the centerstand.
2. Remove screws securing right-hand and left-hand engine fairings (**Figure 2**) and drive belt cover (**Figure 3**) and remove them.
3. Remove the spark plug wire and decompressor valve cable from the cylinder head (**Figure 4**).
4. Loosen, but do not remove, the clamp bolt securing carburetor to intake manifold (**Figure 5**).
5. Remove the carburetor and air filter by pulling them off the intake manifold toward the rear of the moped. Do not separate or remove them.
6. Unhook the magneto wires (leave them attached to the magneto). Pry open frame clamp (**Figure 6**) with a screwdriver and remove spark plug wire.
7. Remove the magneto as described under *Magneto Removal/Installation* in Chapter Eight.
8. Remove the muffler by unscrewing the fitting securing it to the cylinder (**Figure 7**). Remove the bolt and nut securing the muffler to frame mounting bracket (**Figure 8**).
9. Remove drive belt by prying it off the pulley at the bottom (**Figure 9**) and rotate pulley (**Figure 10**) until belt is free.
10. Remove clutch assembly as described under *Clutch/Transmission Removal/Installation* in Chapter Six.
11. Remove the 3 bolts, lockwashers and nuts (**Figure 11**) securing the engine to the engine bracket and remove engine.
12. Install by reversing the removal steps.

CYLINDER HEAD

Removal/Installation

The cylinder head may be removed for service without removing the engine from the frame.

1. Place moped on the centerstand.
2. Remove screws securing right-hand and left-hand engine fairings (**Figure 2**) and remove them.
3. Remove spark plug wire, spark plug, and decompressor valve cable (**Figure 4**).

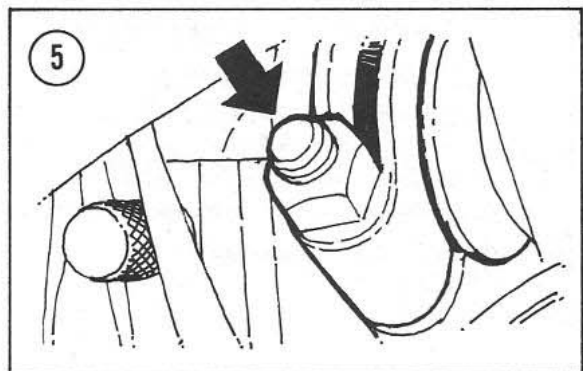
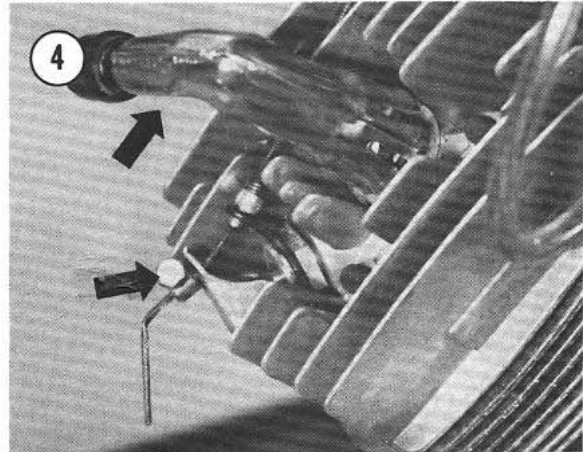
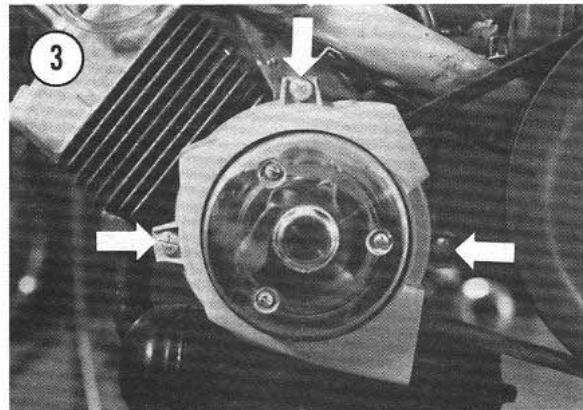
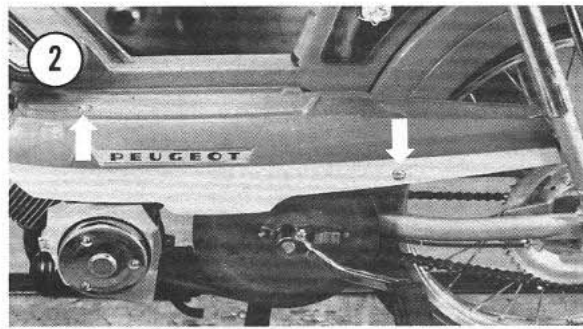

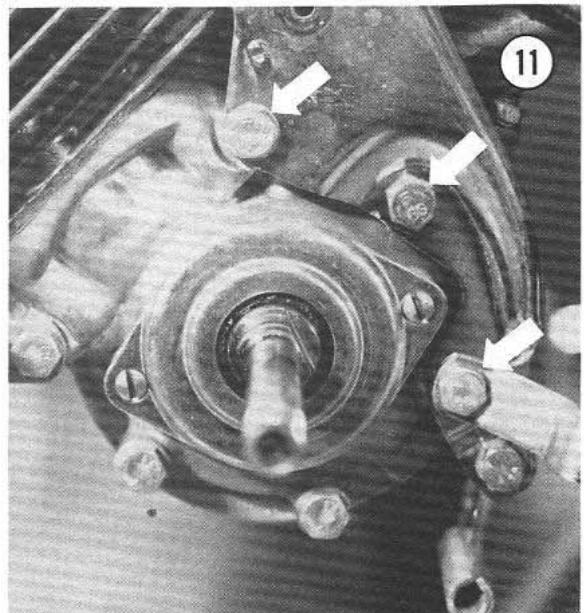
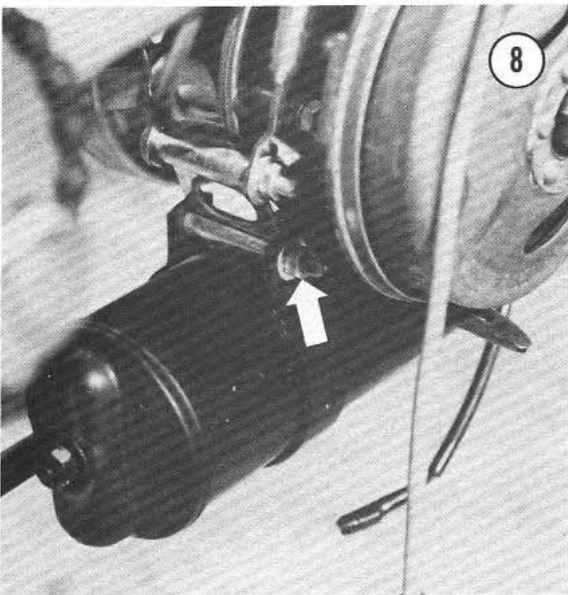
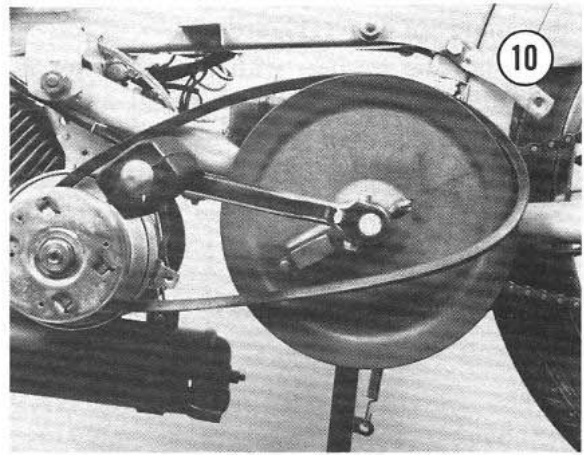
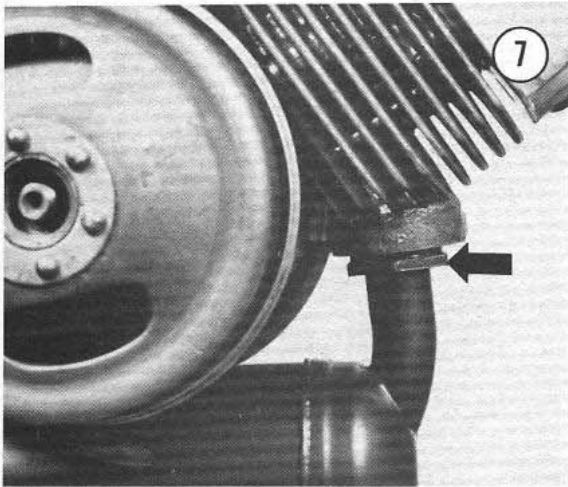
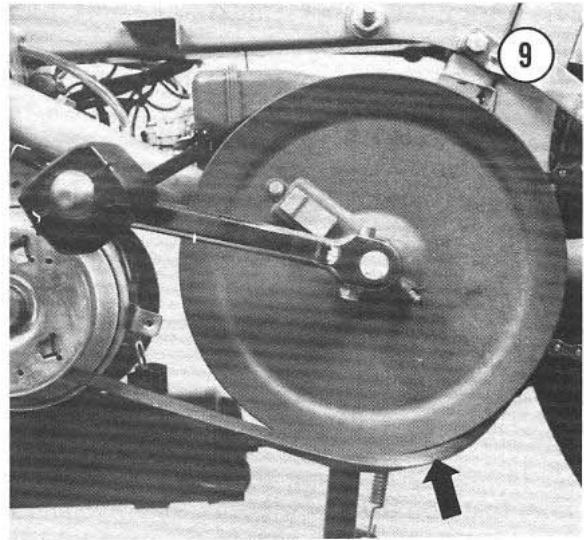
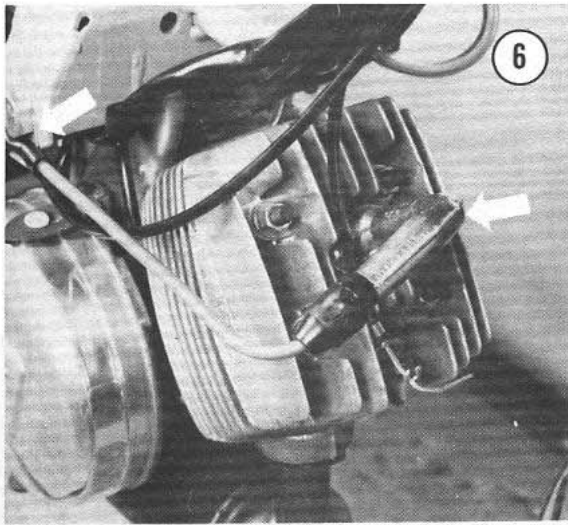

5

4. Loosen, but do not remove, the 4 nuts securing the cylinder head to the engine (**Figure 12**).

CAUTION

*To prevent warping the head, loosen the 4 nuts in the sequence shown in **Figure 13**.*

After all nuts have been loosened, remove the nuts and washers.

5. Gently wiggle the head and pull it off of the cylinder.

6. Remove the cylinder head gasket and discard it.

7. Install by reversing the removal steps. Be sure that you use a new head gasket. Align the hole in the gasket with the hole in the cylinder and cylinder head that is provided for the decompressor outlet (**Figure 14**).

8. Install the washers with the serrations *up*, toward the nuts. Finger-tighten all nuts snug and then torque them in the sequence they were removed (**Figure 13**). Torque all nuts to 8 ft.-lb. (10.85 N·m).

CYLINDER

Removal

The cylinder can be removed for service without removing the engine assembly from frame.

1. Remove cylinder head as described under *Cylinder Head Removal/Installation* in this chapter.

2. Unscrew the fitting securing the muffler to the cylinder (**Figure 15**). Just let it down; there is no need to remove it.

3. Remove the cylinder from the crankcase. If it is stuck, rotate the crank pedal to position the piston to the bottom of its stroke. Gently tap on the exhaust port with a rubber or plastic mallet. If engine assembly has been removed from the frame, place cylinder and crankcase assembly upside down on the crankcase studs. Tap the exhaust port with a rubber or plastic mallet (**Figure 16**).

CAUTION

Do not tap on the cooling fins as they are fragile and may be damaged.

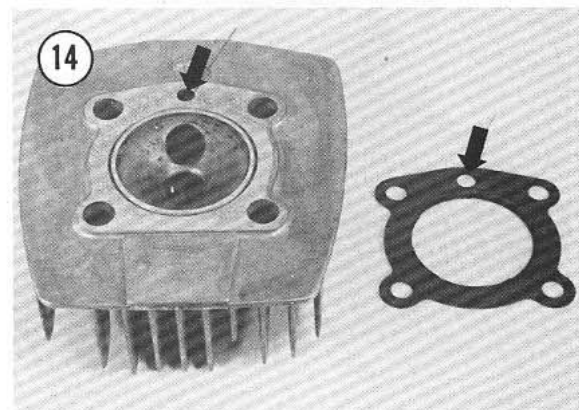
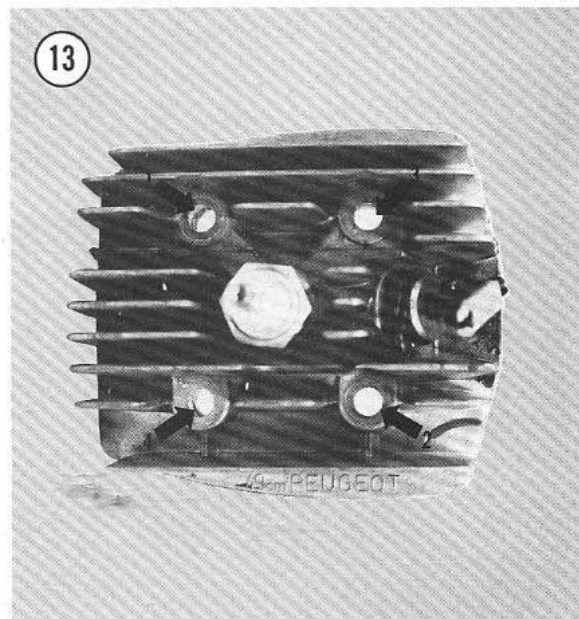
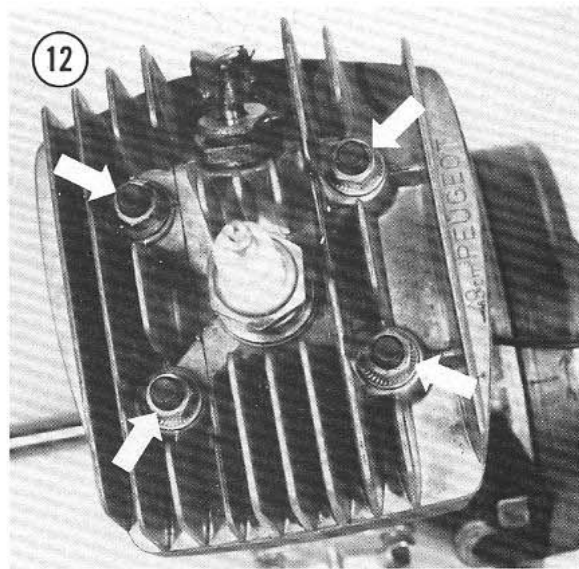

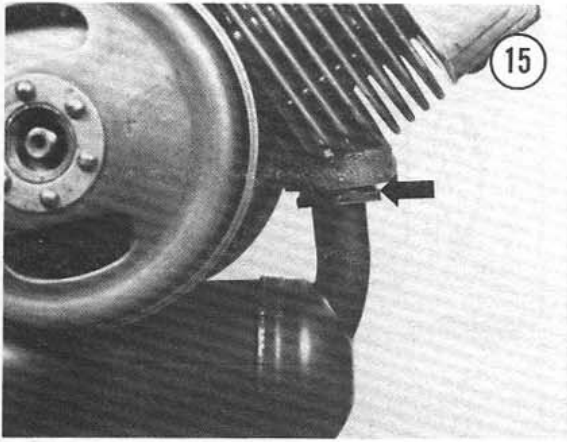

4. Pull the cylinder straight off the crankcase studs (Figure 17).

5. Remove the cylinder gasket and discard it. Place clean rags into the crankcase opening to prevent the entry of small parts and foreign matter.

Installation

1. Clean off surfaces of the base of the cylinder and the top of the crankcase prior to installing the new base gasket.

2. Apply gasket cement to only one side of the gasket and place this side onto the crankcase.

NOTE: To make cylinder installation easier, use a wood block holding fixture (Figure 18) to hold the piston in position. Slide the fixture between the crankcase studs with the connecting rod fitting into the slot.

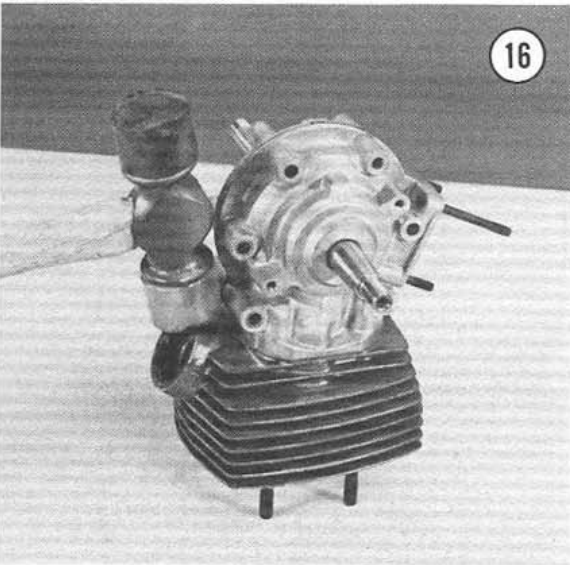

3. Make sure the piston ring gaps align with the stop in the piston ring groove (Figure 19).

5

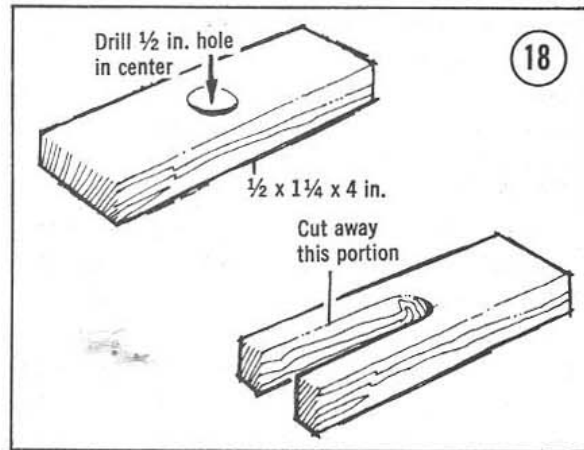
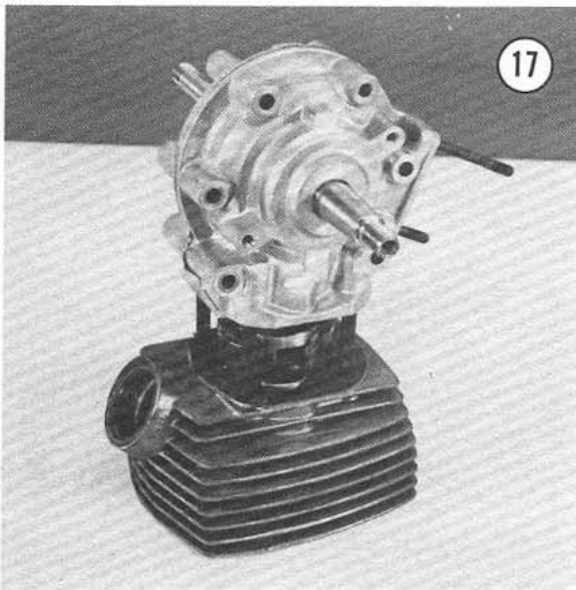

4. Push the cylinder down over the piston by hand only; do not use a hammer or mallet. Compress each ring as it enters the cylinder.
5. Remove the wood holding fixture and push the cylinder down until it bottoms.
6. Install the fitting securing the muffler to the cylinder (**Figure 15**).
7. Install the cylinder head as described under *Cylinder Head Removal/Installation* in this chapter. Be sure to use a new head gasket.

PISTON AND WRIST PIN

Removal/Installation

Prior to removal of wrist pin, hold the rod tightly and rock the piston as shown in **Figure 20**. Any rocking movement (do not confuse with a sliding motion which is normal) indicates wear to the wrist pin, rod bearing, wrist pin bore or more likely, a combination of all three.

1. Remove the 2 wrist pin snap rings (**Figure 21**) with 90° snap ring pliers (**Figure 22**).
2. Push out the wrist pin with the homemade tool as shown in (**Figure 23**). If wrist pin is to be reused, it should be marked so it will be reinstalled in the same position.
3. Push out the needle bearing race from the connecting rod, clean and inspect it. If it is OK, thoroughly oil with lightweight oil and fit it back into the connecting rod. If the condition is doubtful, replace it.
4. Install by reversing the removal steps, make sure the reference letters (**Figure 24**) on top of the piston is toward the exhaust port when repositioning it on the connecting rod.

NOTE: Install wrist pin with the same tool used for removal (Figure 23). Eliminate the piece of pipe.

5. Carefully align the piston to the connecting rod when installing the wrist pin to avoid damage to the needle bearings. Install the wrist pin, refer to the mark made in Step 2 if reusing the old wrist pin.
6. As the wrist pin is being pushed back into the piston and connecting rod bearing, observe its travel, from underneath the piston, to prevent any binding.

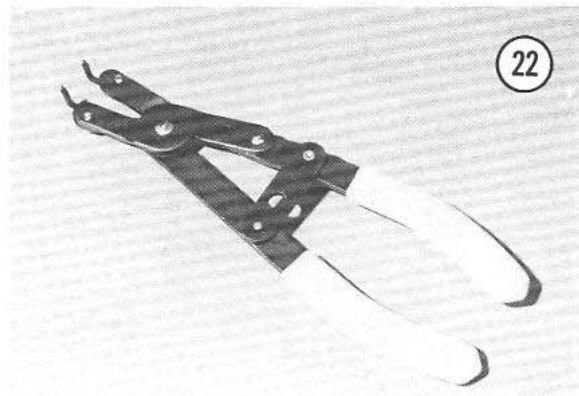
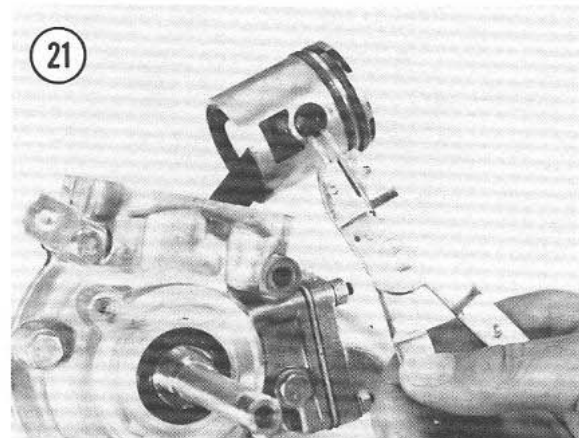
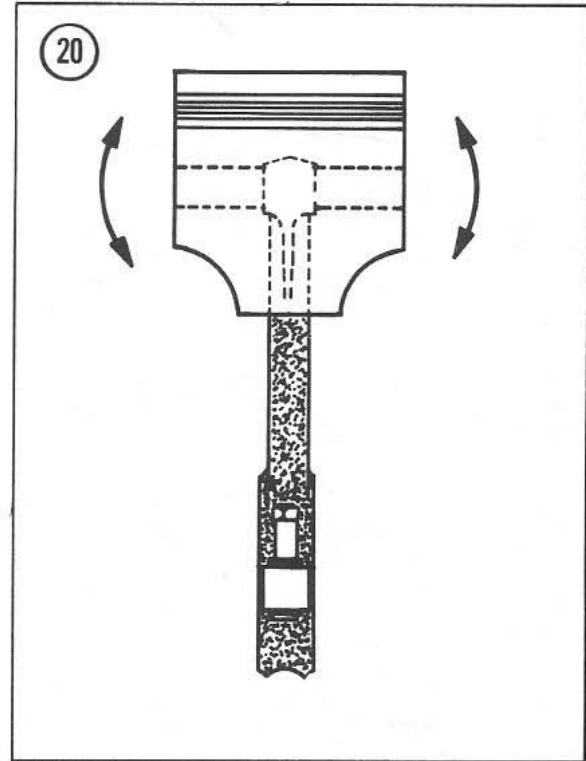

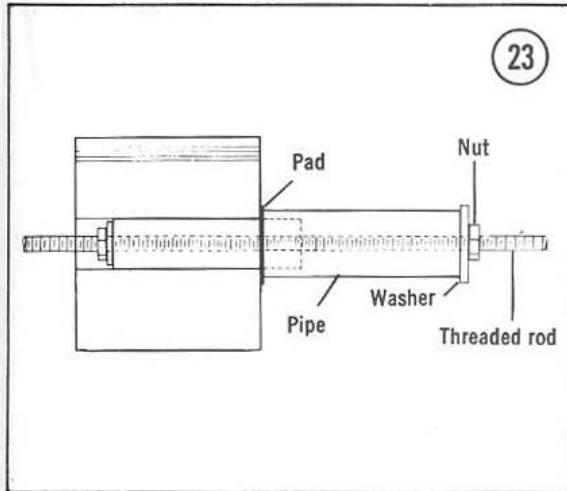

NOTE: Make sure that the snap rings are seated correctly in the piston.

7. After installing the wrist pin, check the surface of the piston where the installation tool came in contact with it. If there are scuff marks, clean them off with a fine file. File as little as possible being careful not to remove too much metal.

PISTON CLEANING AND INSPECTION

1. Scrape all carbon from the top of piston with a dull screwdriver, be careful not to scratch the surface.
2. Clean out the grooves with a broken ring or sharp, small screwdriver.
3. Clean out the wrist pin snap ring grooves.
4. Inspect the piston top and skirt for cracks or damage, replace if necessary.

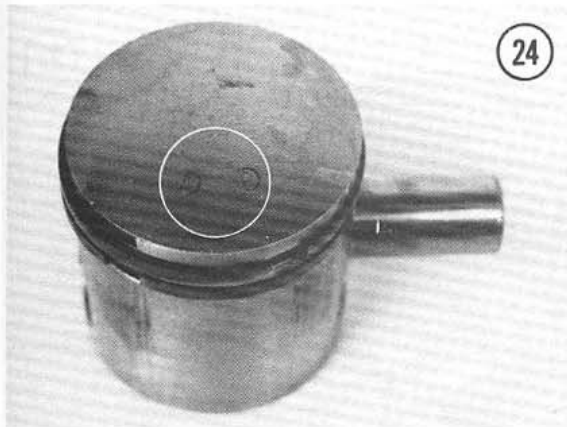

PISTON RING REPLACEMENT

Piston rings can be replaced without removing the piston from the connecting rod.

1. Remove top ring first by spreading each end, with your thumbs or a ring expander, just enough to slide it up and over the piston. See Figure 25.
2. Repeat the same procedure for the second ring.
3. Clean out all carbon deposits from ring grooves. Inspect groove for burrs, nicks, or broken and cracked surfaces.
4. Check the gap of each ring by inserting the ring into the bottom of the cylinder bore about $\frac{5}{8}$ inch and square it to the wall by tapping it with the piston. Insert feeler gauge as shown in Figure 26. The gap should not exceed 0.012 in. (0.3mm). If the gap is smaller than specified, hold a small file in a vise, grip the ends of the ring with your fingers and move ring up and down on the file slowly and enlarge the gap (Figure 27). Do a little at a time to avoid removing too much and ruining the ring.
5. Prior to installation in the piston, roll each ring around its groove as shown in Figure 28 to check for binding. Minor binding may be cleaned up with a fine cut file.

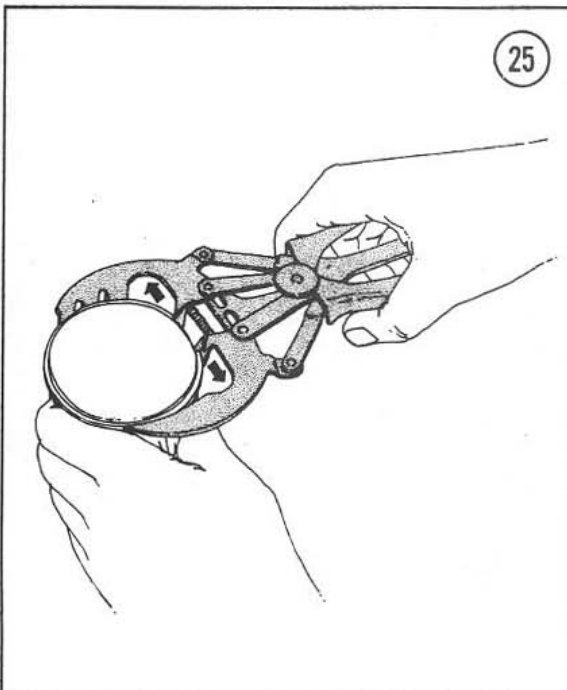

- Spread the rings carefully with your thumbs or a piston ring expander — just enough to slip them down and over the piston.

NOTE: *Install the lower ring first and then the top.*

- Align the end gaps of the rings with the locating pins in each ring groove as shown in **Figure 19**.

DECOMPRESSOR VALVE

Removal/Installation

- Remove cylinder head as described under *Cylinder Head Removal/Installation* in this chapter.
- Insert 2 bolts, from the top, through the crankcase stud holes in the head and secure bolts in a vise. Be careful not to damage bottom surface of head.
- Clip off the end of the pivot pin (**Figure 29**), compress the spring and remove pin.
- Remove the valve through the bottom side of the head.
- Pry open the hairpin spring with a screwdriver (**Figure 29**).
- Remove the valve body from the cylinder head using a 19mm socket.
- Install by reversing the removal steps.

NOTE: *Engine performance depends greatly on the tightness of this valve in the cylinder head. Be sure to check and clean the mating surfaces of the valve to the cylinder head prior to installation. If there are any defects on the valve face, replace it.*

- Torque the valve body into the cylinder head to 27 ft. lb. (37 N·m).
- Be sure to flatten the end of the new pivot pin to hold the valve securely in place.

CAUTION

If this pin works loose when the engine is running, it will allow the valve to drop into the cylinder and severely damage the engine.

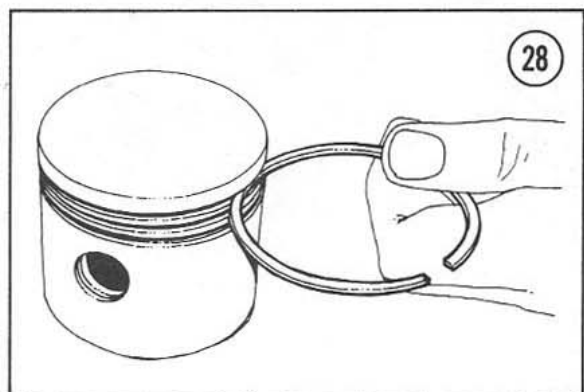
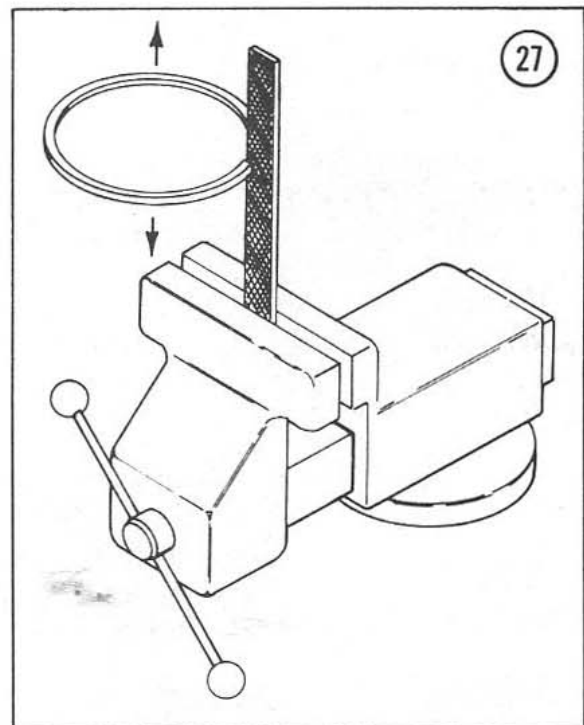
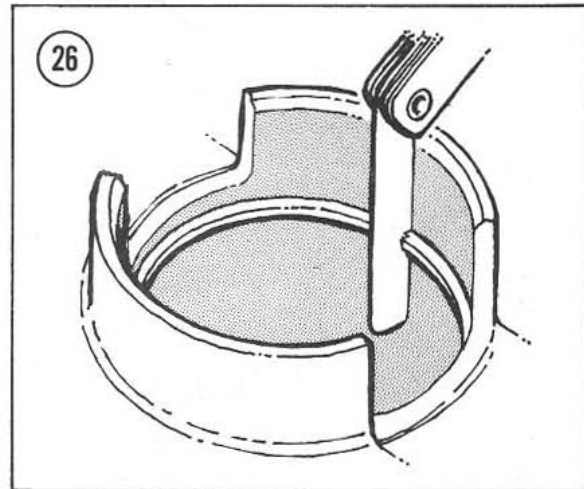

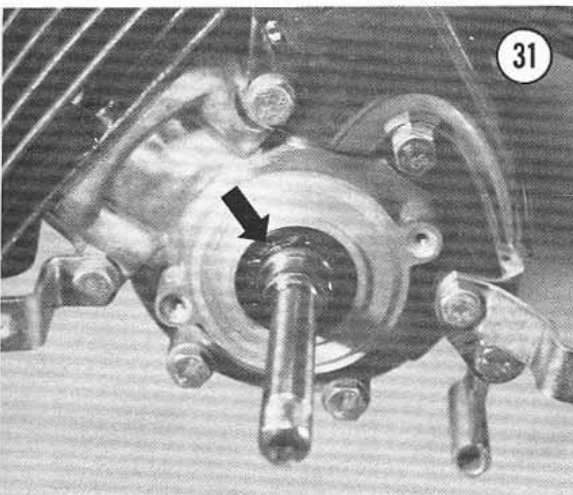
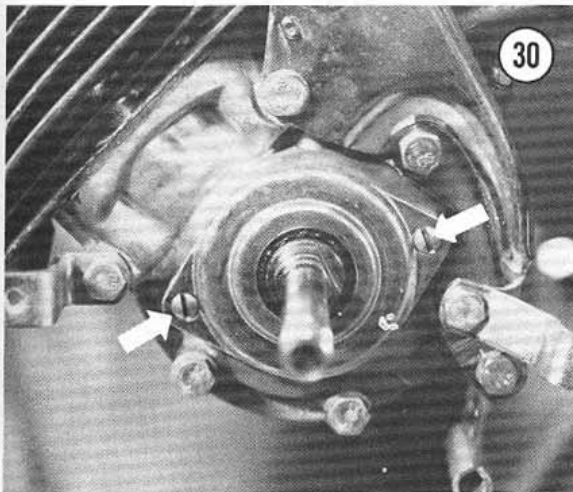
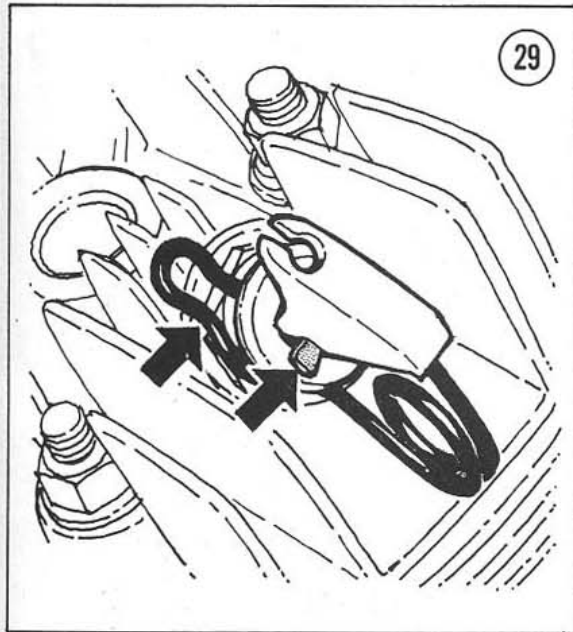

CRANKSHAFT SEAL

Removal/Installation

1. Remove the clutch/transmission as described under *Clutch/Transmission Removal/Installation* in Chapter Six.
2. Remove the 2 screws securing the seal holding plate to the crankcase (**Figure 30**).
3. Remove the old seal (**Figure 31**) with a screwdriver, be careful not to damage the recess the seal fits into.
4. Wipe the recess clean with a clean cloth.
5. Place the new seal into the recess and press it into place with a piece of pipe or rigid tubing. The pipe should be about 4 in. long and have an inside diameter of $\frac{7}{8}$ in.
6. Replace the seal holding plate.

CAUTION

The screws securing the seal attachment plate are self tapping and may easily strip out the threads in the crankcase. When starting the screws, rotate the screw backwards until you feel a click, then rotate in the proper direction until tight. Do not overtighten.

INTAKE VALVE

Removal/Installation

Intake manifold nuts are inaccessible for removal with the engine in the frame. It is necessary to remove the cylinder from the engine as described under *Cylinder Removal/Installation* in this chapter.

1. Remove the 4 nuts and lockwashers securing the intake manifold to the cylinder (**Figure 32**).

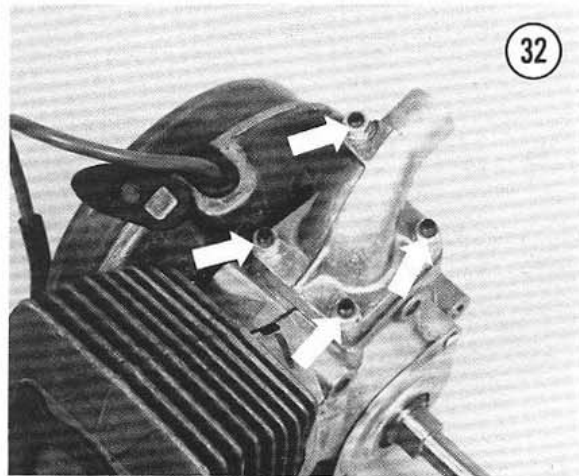

2. Remove the intake manifold and valve assembly (Figure 33).
3. Carefully handle the valve assembly, do not bend the thrust prongs (Figure 34).
4. Inspect the prongs and reeds for damage, replace if they are bent or buckled.
5. Install by reversing the removal steps. Torque all nuts to 4 ft.-lb. (5.4 N·m).

NOTE: Be sure to install the valve assembly with the thrust prongs down as shown in Figure 35.

SPLITTING THE CRANKCASE

In order to gain access to the crankshaft, connecting rod, and the crankshaft bearings it is necessary to split the crankcase halves. This procedure is not recommended for the home mechanic as it requires special tools. Considerable money can be saved by removing the engine as described under *Engine Removal/Installation* in this chapter.

Take the crankcase assembly to your moped dealer or motorcycle machine shop.

If the connecting rod needs replacing, the rod and crankshaft must be replaced as a unit. Also check the crankshaft bearings and seals at the same time. Replace any parts if necessary.

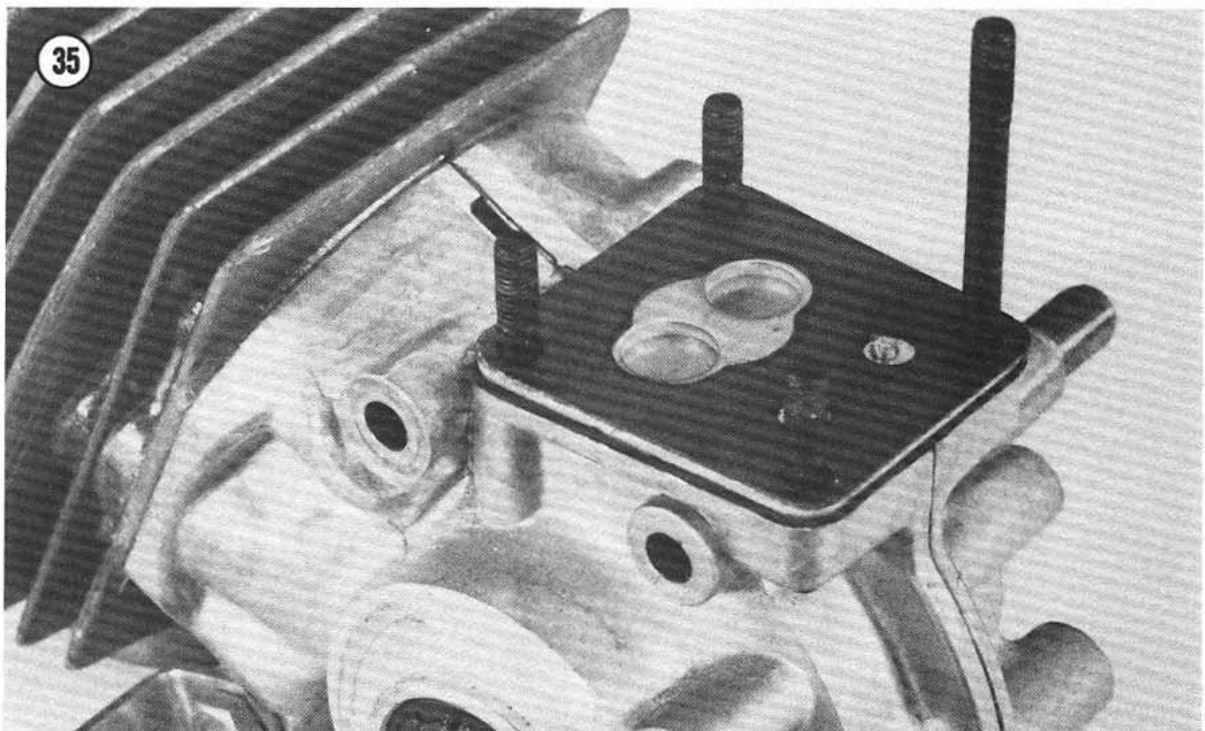
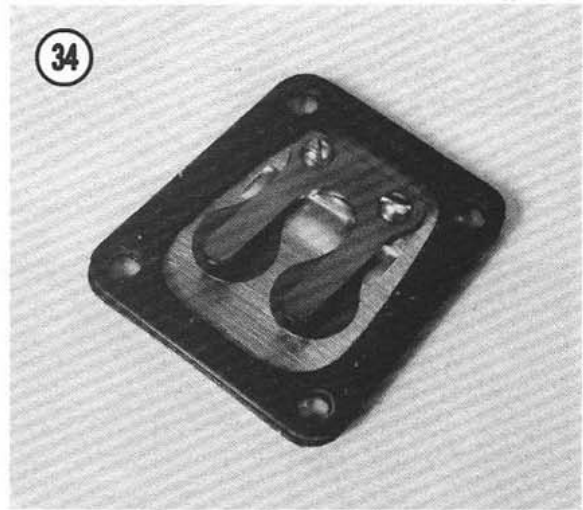
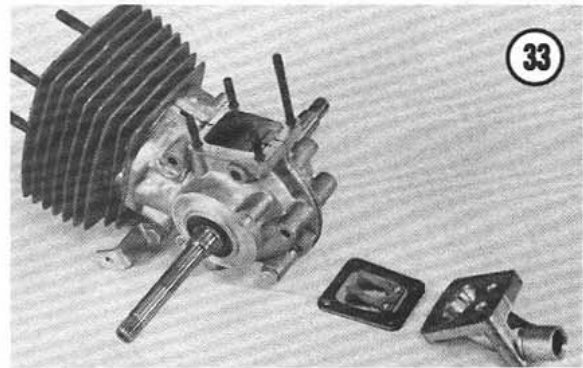

CHAPTER SIX

CLUTCH/TRANSMISSION

The engine power is transmitted to the rear wheel through a primary and secondary clutch/transmission. The primary transmission consists of a drive belt running from the engine crankshaft pulley to the drive pulley, located on the bottom bracket axle. The secondary transmission consists of a chain, driven by the drive pulley, to the sprocket at the rear wheel.

The clutch consists of two systems. First, the primary starting or cranking shoes are used for starting the engine. Second, the centrifugal clutch, which automatically engages at 2,500 rpm, transmitting engine power to the variable drive pulley.

The Peugeot has an automatic and variable drive feature. The expandable pulley varies the drive ratio of the belt as the engine speed increases. This is accomplished by centrifugal weights located within the clutch housing.

When engine speed is low, the drive ratio is high for good acceleration and as engine speed increases the drive ratio is lowered for good balance between engine speed and moped speed.

The engine is mounted in a spring loaded engine bracket to accommodate the change between the drive pulley and engine as the belt position varies. This spring mounting also maintains proper belt tension at all times.

Prior to removing the clutch, clean off all dirt, grease, oil, and foreign matter. Use a cleaner designed specifically for this purpose, like Gunk Degreaser or equivalent. Follow the manufacturer's directions and avoid using too high of a water pressure when rinsing off. Keep water and dirt from entering into the clutch area.

Make sure that the work area is clean; you should have a work bench or flat area on which to set the disassembled parts. Place them in the order that they were removed; this will aid when reassembling the parts.

CLUTCH

Removal

1. Place moped on the centerstand.
2. Remove screws securing left-hand engine fairing (**Figure 1**) and bolts "A" securing the drive belt cover (**Figure 2**). Do not lose the plastic spacer used on the center bolt of the drive belt cover.
3. Remove 3 screws "B" securing the outer clutch cover (**Figure 2**) and remove the cover.

NOTE: *The following procedure requires two people to remove the clutch assembly.*

4. Remove the nut securing the clutch assembly to the crankshaft with an impact driver and a 21mm socket. Have your helper hold the inner clutch cover while you drive off the nut (**Figure 3**) with the impact driver.

5. Pry drive belt off of groove at bottom of drive pulley (**Figure 4**), and slowly rotate pulley (**Figure 5**) and remove belt.

6. Pull entire assembly off of the crankshaft, holding it together tightly with your hands. Hold it tightly to prevent the balls from dropping out. If they do, don't panic, just find all 6 of them.

7. Place the entire assembly on the workbench and disassemble as described under *Clutch Disassembly* in this chapter.

Disassembly

Refer to **Figure 6** for this procedure.

1. Pull the centrifugal clutch lining out from the locking ring.
2. Remove the thrust plate, 6 balls, pressure plate, and beveled washer.

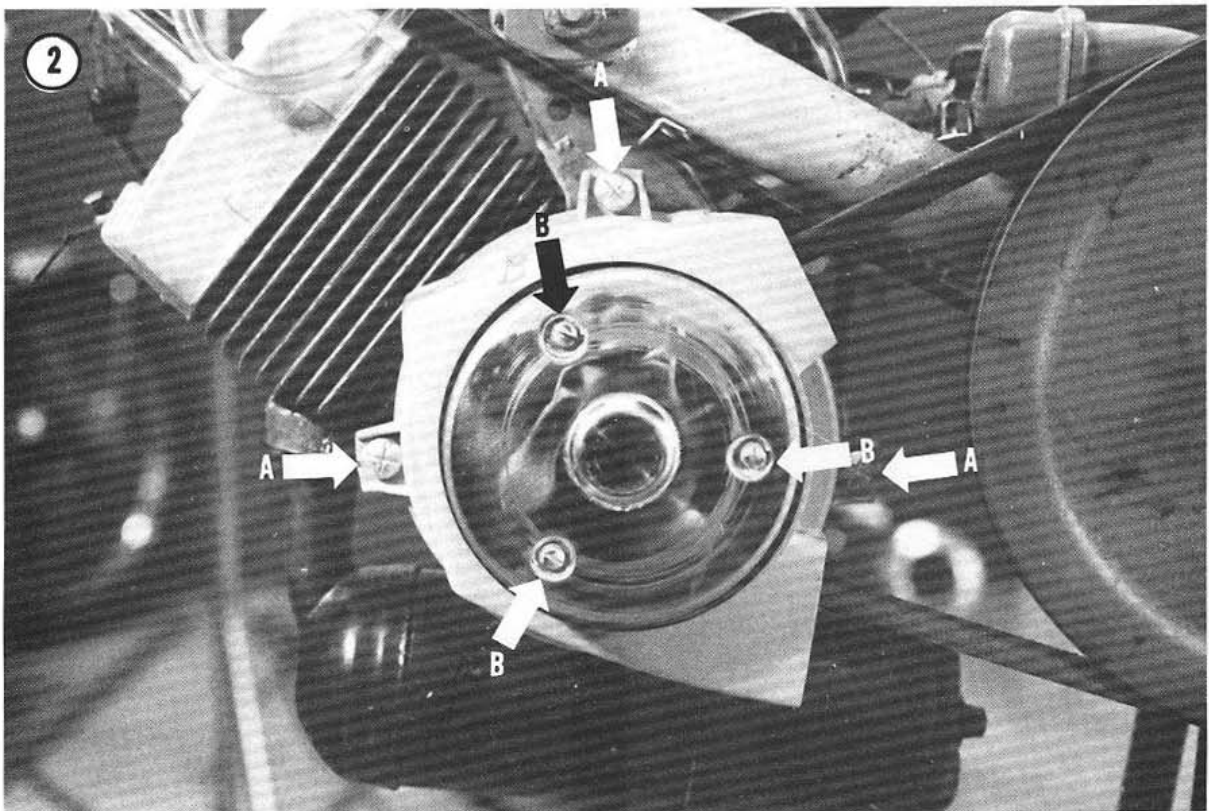
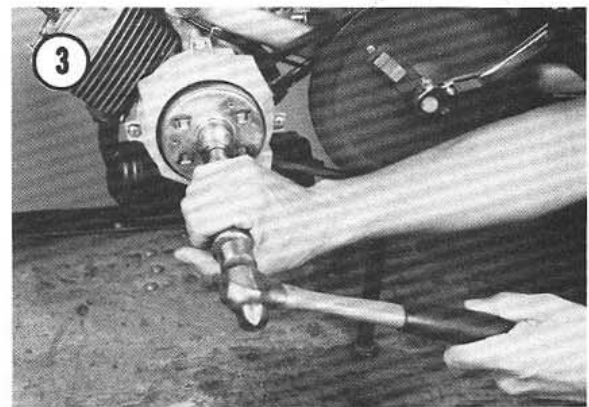
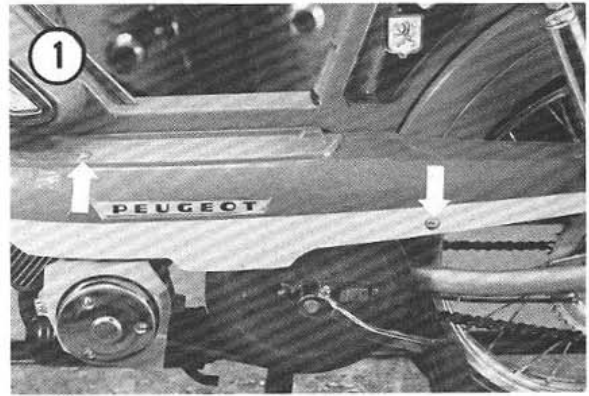

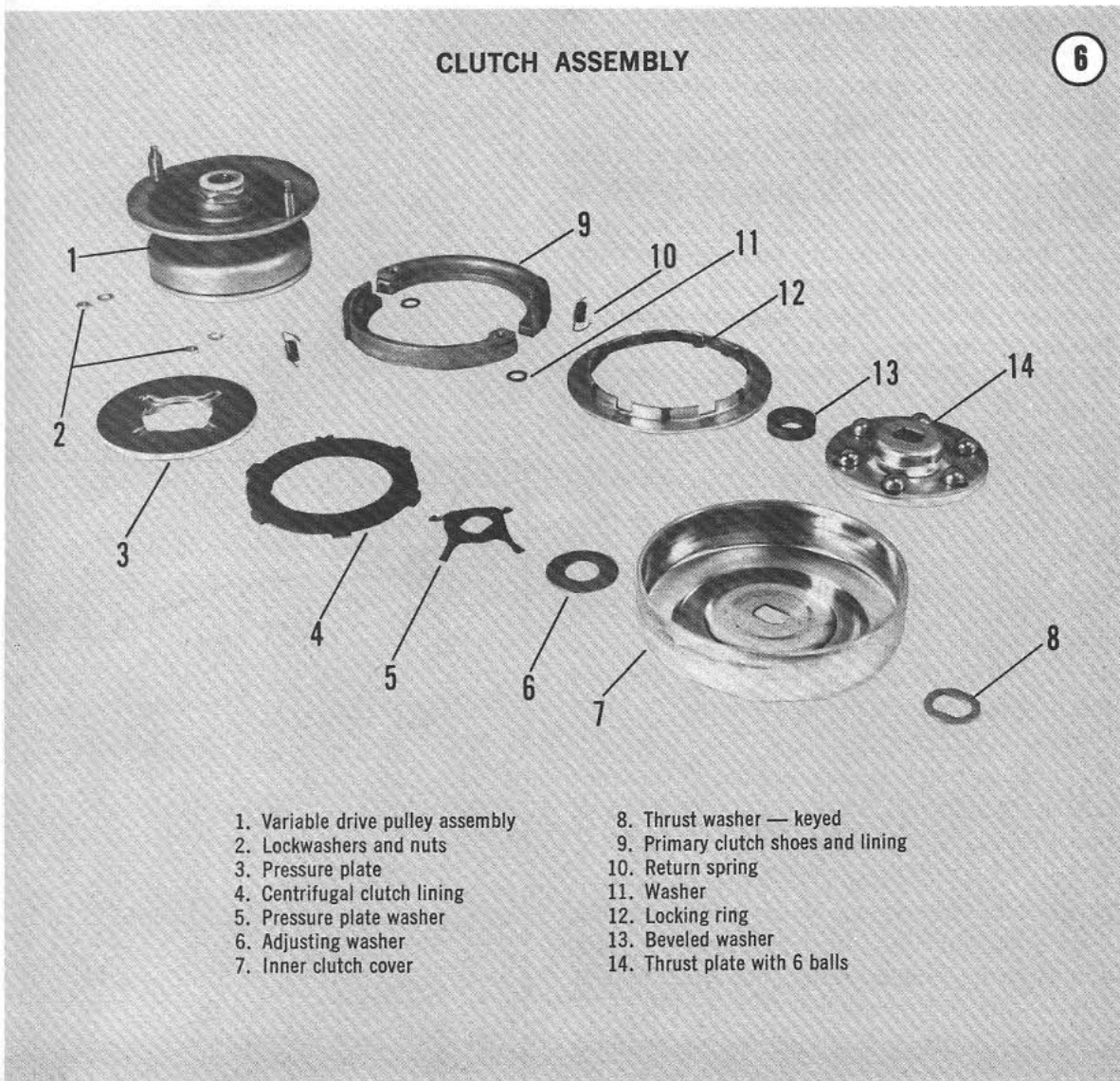
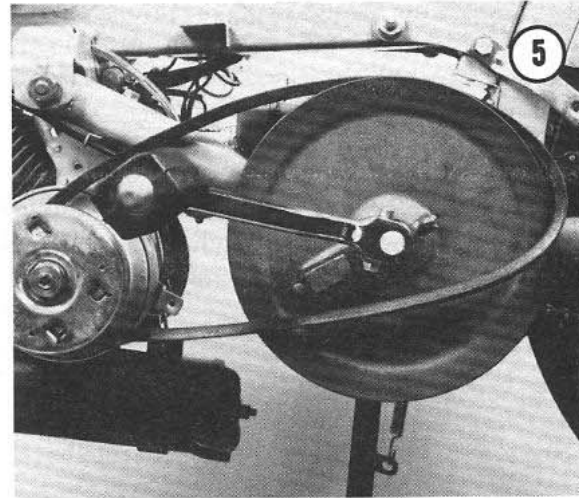
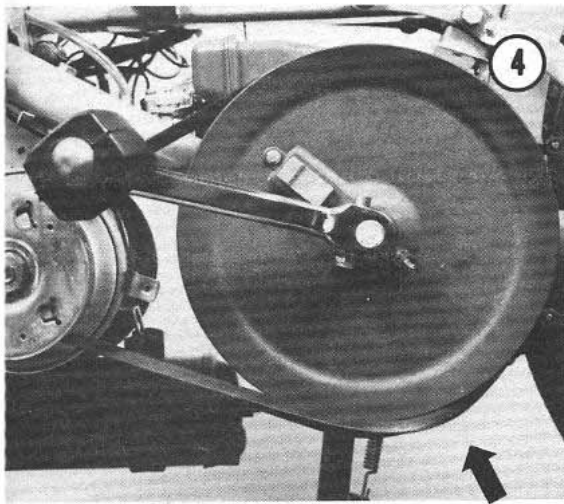

6

3. Remove the nuts securing the primary clutch shoes by releasing the return springs from the pins, and remove the shoes from the studs.

Inspection

1. Check the linings of the primary cranking shoes and the centrifugal clutch for traces of oil and grease. If the linings are contaminated, they should be replaced.
2. Linings should be replaced if the thickness is less than $\frac{1}{32}$ in. (0.8mm).
3. Check the inside surface of the inner clutch cover and the pressure plate for roughness, scoring, or cracks; replace if necessary.
4. Check the thrust plate and balls for roughness or scoring; replace if necessary.
5. Inspect the locking tabs of the centrifugal clutch lining; if any are broken or cracked, the lining should be replaced.
6. Make sure the primary cranking shoe return springs are not broken, bent, or stretched; replace if necessary.

If there is oil in the clutch housing, check the crankshaft seal for damage and replace if necessary. Refer to *Crankshaft Seal Removal/Installation* in Chapter Five.

Assembly

Refer to **Figure 6** for this procedure.

NOTE: This procedure is to be performed on the workbench prior to installation on the engine.

1. Reassemble the variable drive pulley, if it was disassembled, as described under *Variable Drive Pulley Disassembly/Assembly* in this chapter.
2. Insert the inner sleeves and needle bearings into the holding plate shaft of the variable drive pulley assembly (**Figure 7**).
3. Insert large end of return spring into slot in primary clutch shoe and place onto anchor pin (**Figure 8**). Make sure the open end of the hook is in toward the center of the drive plate. Repeat this step for the other shoe.
4. Hook the other end of the return spring onto the *second stud* of the other shoe (**Figure 9**).

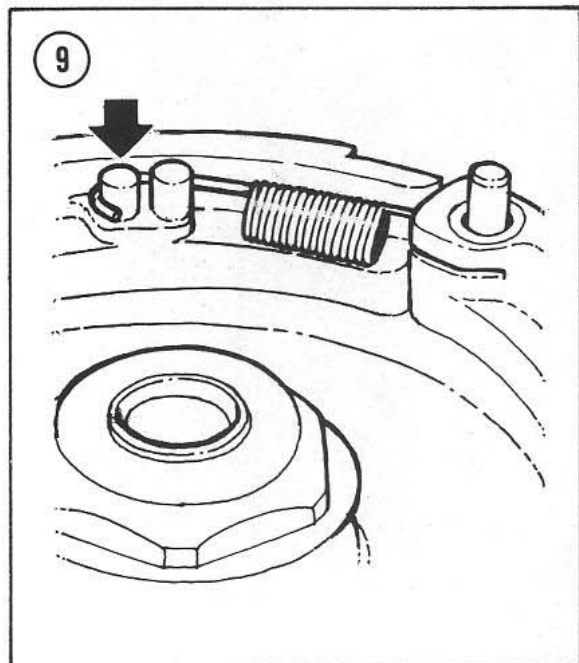
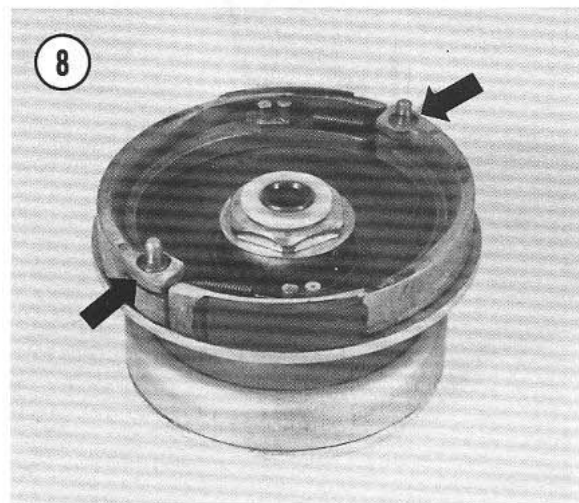
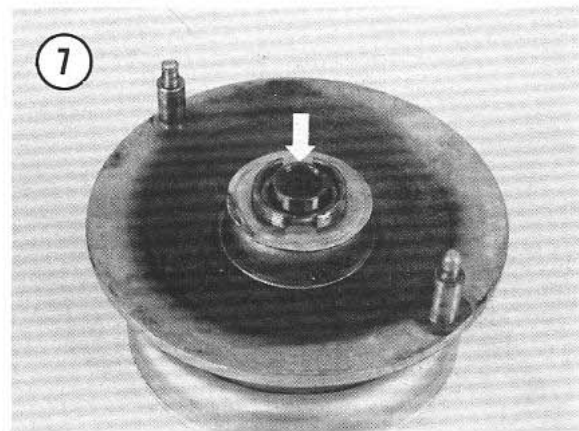

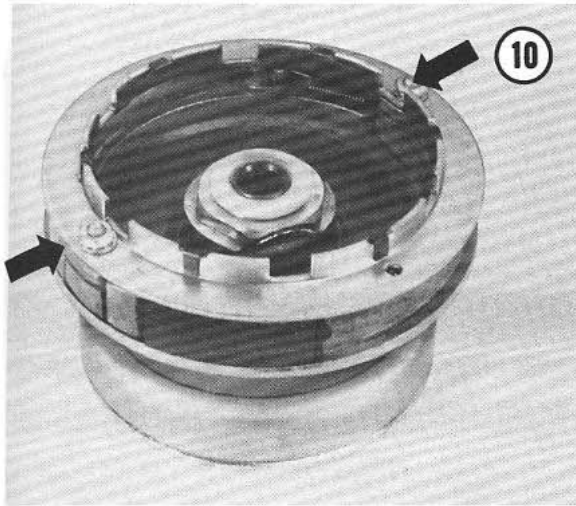

5. Install the locking ring onto the anchor pins and secure with lockwashers and nuts (**Figure 10**). Tighten nuts and position them so the flat side of the nut is parallel to the side of the locking ring. This is necessary so that there will be no interference with the centrifugal clutch lining when it is positioned.

6. Place the beveled washer in place, make sure that it is positioned with the beveled side *up* (**Figure 11**).

7. Insert the thrust plate and set the 6 balls into it (**Figure 12**).

CAUTION

Prior to the installation of the balls, wipe them clean with a dry cloth. Apply a thin coat of graphite base grease to each ball. This is necessary so that the balls will not rust.

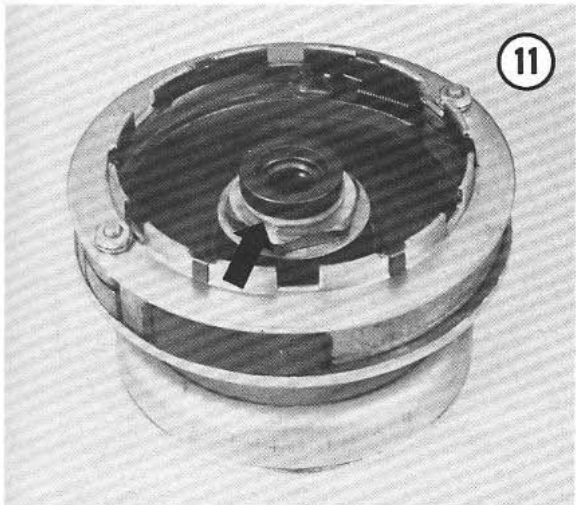

8. Position the pressure plate over the thrust plate and balls so that 2 of the notches in the center of the pressure plate align with the flat sides of the hole in the thrust plate (**Figure 13**). This is necessary so that the pressure plate washer will fit into it properly when installed on the engine crankshaft.

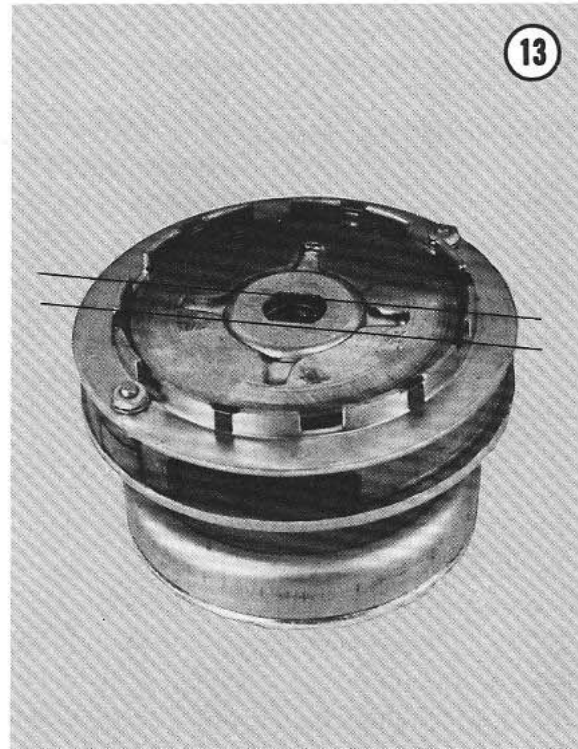
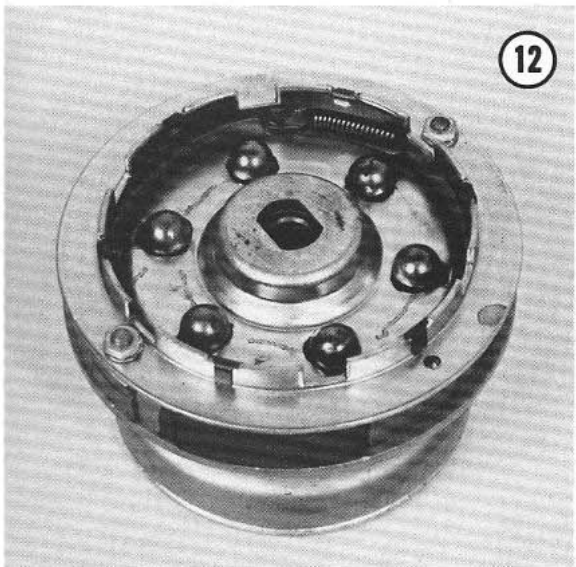

9. Press the centrifugal clutch lining down into the locking ring; make sure that it is in completely (Figure 14).

NOTE: Disregard the V-notch on one of the locking tabs. It does not have to be positioned in any specific place, this is only a manufacturing mark.

Installation

NOTE: Make sure that the drive belt cover brackets (Figure 15) are in the correct position. Slide the inner clutch cover on the crankshaft and check this alignment, adjust if necessary and tighten bolts securely. Remove the inner clutch cover and proceed.

1. Install the keyed thrust washer (Figure 16), the inner clutch cover and adjusting washer (Figure 17), and the pressure plate washer (Figure 18) onto the crankshaft in this order.

2. Pick up the assembled unit, holding fingers over each end to prevent washers, bearings, and sleeves from falling out.

NOTE: Before installing this assembly onto the shaft, align the inner flat surfaces of the thrust plate with the flat surfaces of the crankshaft.

3. Install the assembly onto the shaft, holding it together tightly to prevent the balls from falling out, and push it on as it will go (Figure 19). Do not force it as it reaches the end of its travel. Rotate it slightly to make final alignment between the flats on the thrust plate and the shaft. Push it on until it bottoms. If any parts fall out, reassemble it on the bench and try again.

4. Install the nut and finger-tighten it. Secure it with an impact driver and 21mm socket.

NOTE: Rotate the clutch housing by hand to make sure that it rotates freely. If not, locate the problem before continuing.

5. Install the chrome outer clutch cover.

6. Install the drive belt by hooking the belt onto the clutch pulley and starting it onto the groove on top of the drive pulley. Rotate the pulley until the belt runs completely into place.

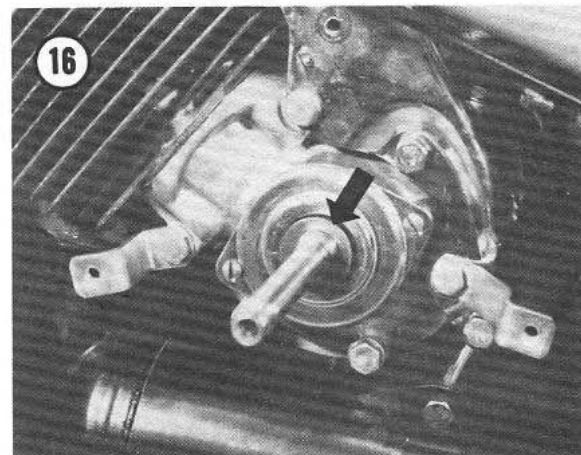
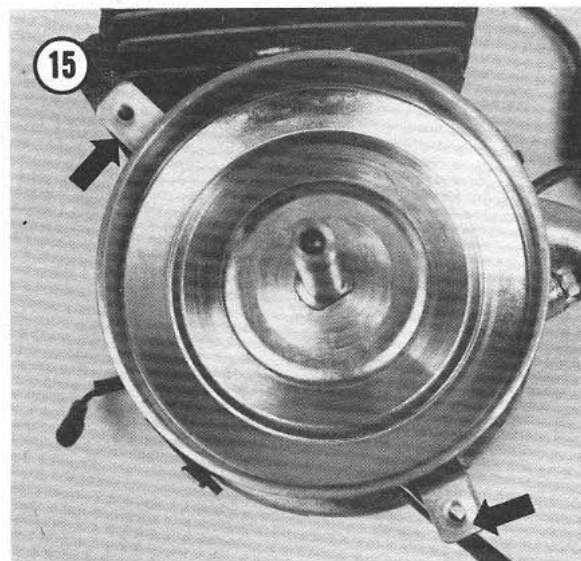
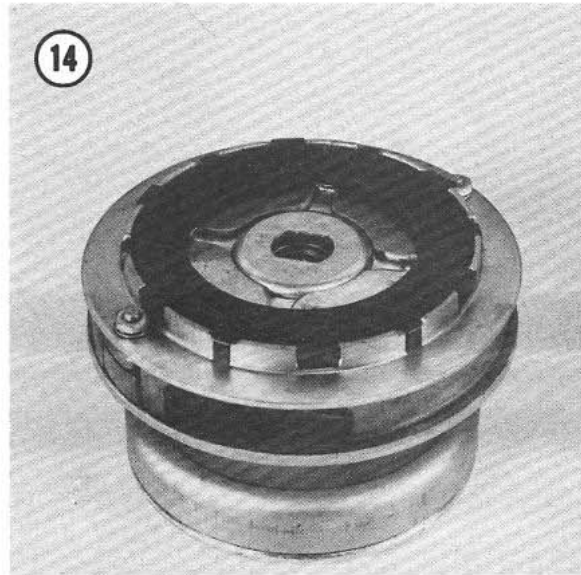

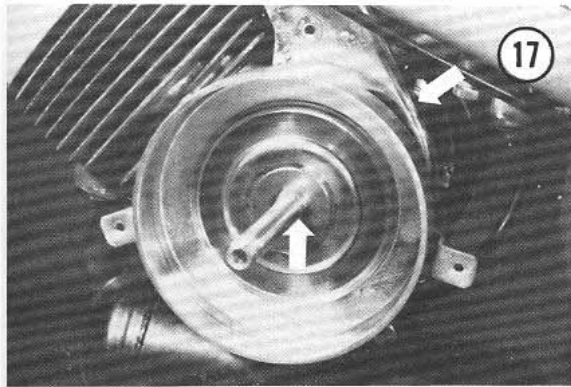

7. Install the drive belt cover, be sure to use the plastic spacer with the center bolt.
8. Install the engine fairing.

VARIABLE DRIVE PULLEY

Refer to **Figure 20** for this procedure.

Disassembly/Assembly

1. Secure holding plate in vise. *Do not* grip the variable drive plate at the same time (**Figure 21**), as it will become distorted and will have to be replaced.

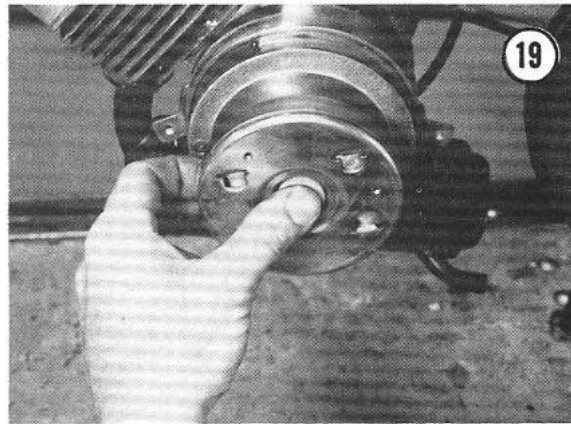
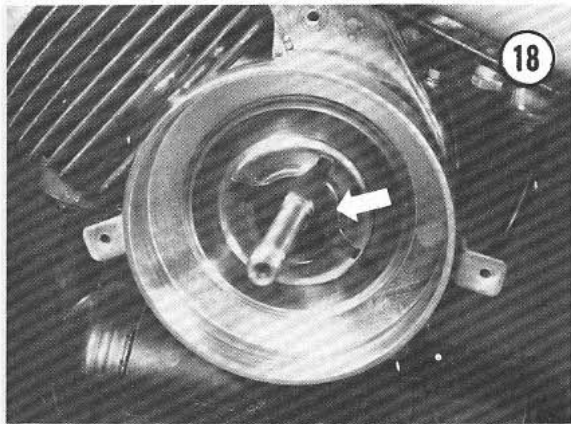

6

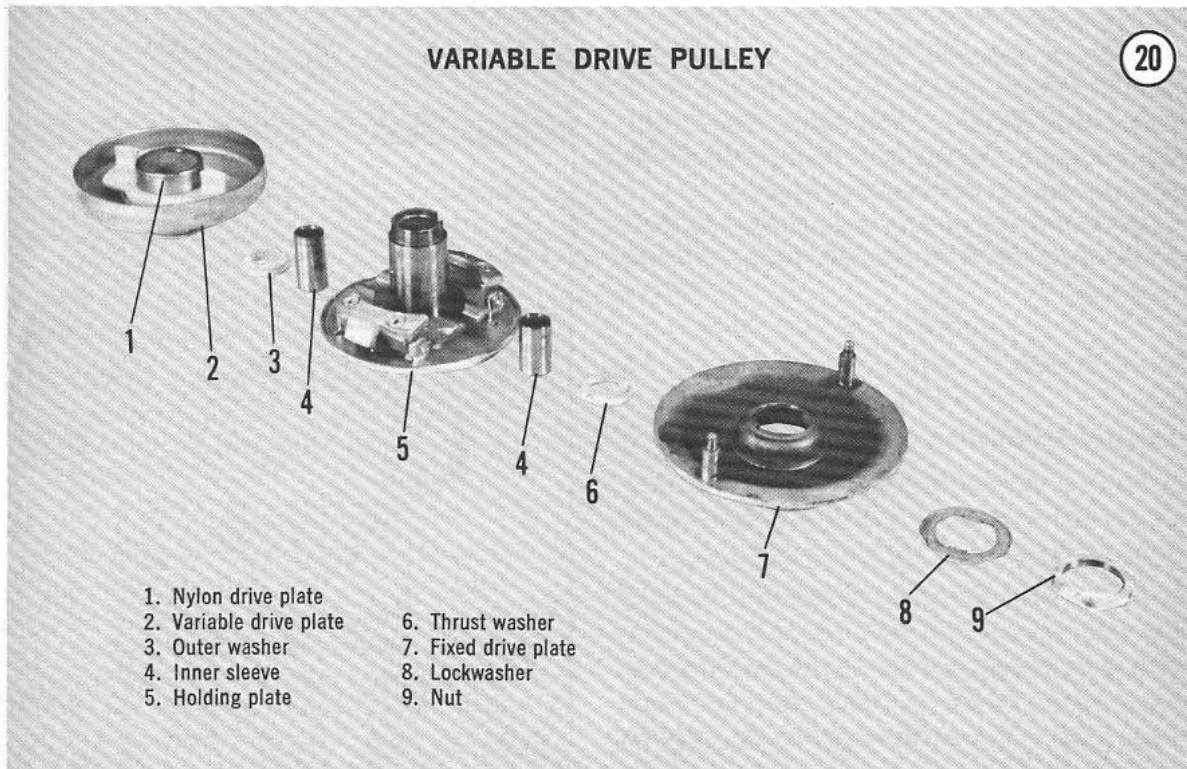

2. Bend down the locking tabs of the lock-washer and remove the nut.
3. Remove the fixed drive and variable drive plates.
4. If it is necessary to remove the nylon drive plate, use a broad tip screwdriver and pry it out of the variable drive plate.
5. Assemble by reversing the disassembly steps. Torque the nut to 40 ft.-lb. (54 N•m) and pry up the locking tabs on the locknut.

Inspection

Check the surfaces of the nylon drive plate for excessive wear or damage. Check the centrifugal weights for ease of movement on their pivot pins and signs of wear or damage. Replace any parts if necessary.

PEDALS

Removal/Installation

A bent or broken pedal is very dangerous. Replace it immediately. To remove the right pedal, use a wrench on the spindle (**Figure 22**) and loosen it *counterclockwise*. On a left pedal, loosen *clockwise*; the left pedal has special left-hand threads.

Take the defective pedal to your dealer. Carefully match the threads with the new pedal to guarantee an exact replacement. The threaded portion must be the same diameter and have the same number of threads-per-inch.

Install the pedal(s) by tightening the right pedal *clockwise* and the left pedal *counterclockwise*.

CRANK ARM

Removal/Installation

1. Make a cut-out in a hardwood block (**Figure 23**) and set it on a block of wood so that the crank arm is held in a horizontal position.
2. Remove the nut and washer on the cotter pin.
3. Rest the crank on the hardwood block so that the end of the cotter pin is over the cut-out (**Figure 23**). Have someone hold the opposite pedal securely.

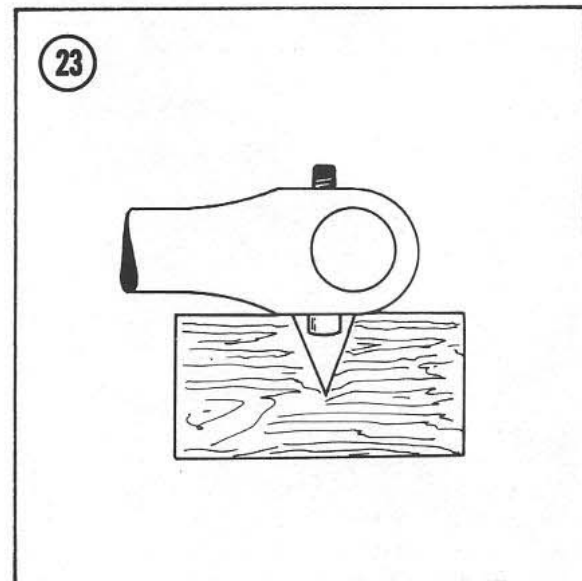
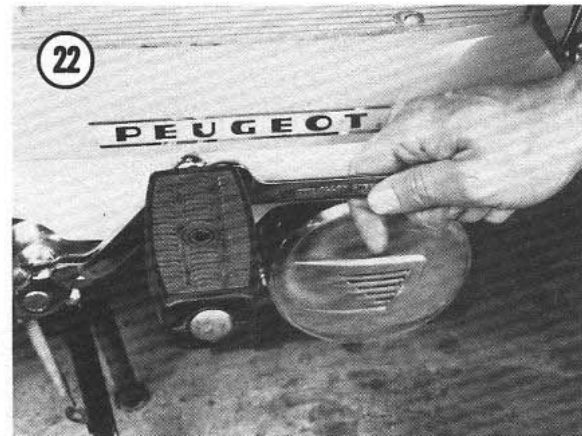
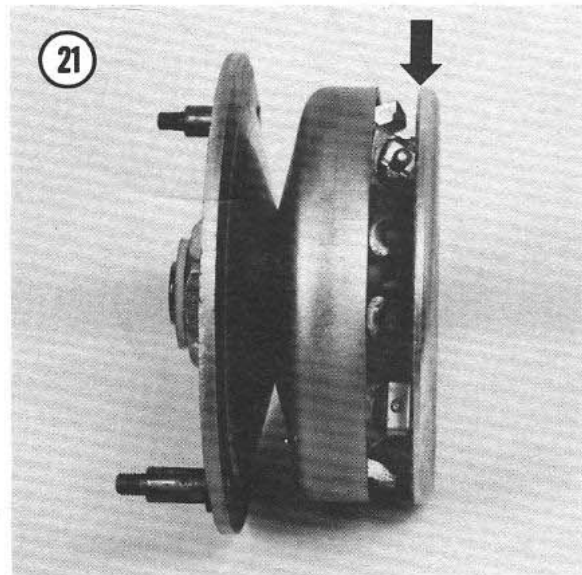

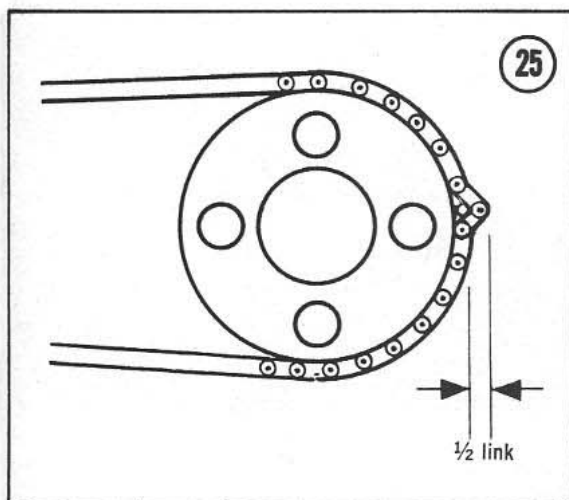
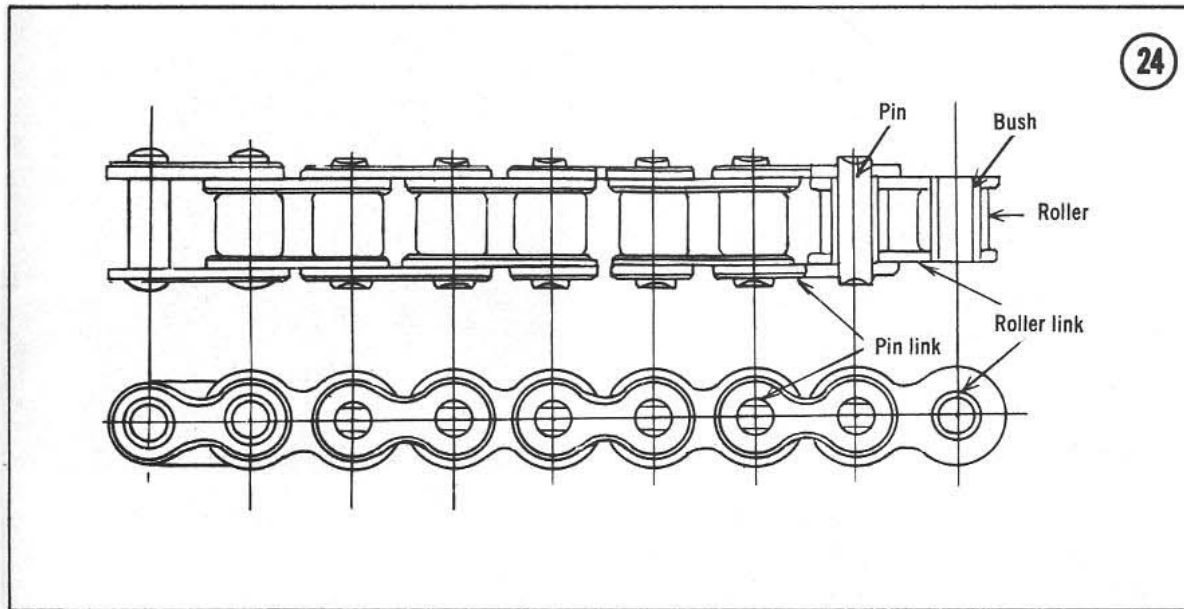

4. Rap on the threaded end of the cotter pin with a brass or aluminum rod and a hammer.

NOTE: *It may be necessary to use penetrating oil, like Luquid Wrench or WD-40, on the cotter pin to aid in removal.*

CAUTION

Do not attempt this unless the crank is firmly supported on the hardwood block. If you pound on the cotter pin without support, the bottom bracket bearings will be damaged. In addition, do not hit the cotter pin directly with a metal hammer or steel drift as the threaded end will be damaged.

5. When the cotter pin is loose, remove it.
 6. Pull off the crank.
 7. Check each crank for straightness by sighting down its length. If bent, replace it with an exact duplicate.
 8. Slide the crank(s) onto the axle with the cotter pin hole aligned with the axle slot.
 9. Install the cotter pin with a washer and nut. Tighten the nut finger-tight.
 10. Support the crank on the hardwood block as in Step 3 except with the threaded end of the cotter pin over the cut-out.
 11. Drive the cotter pin in by pounding with a plastic mallet or a hammer and brass or aluminum rod. Two or three blows should be sufficient.
 12. Tighten the cotter pin nuts.
 13. After about 100 miles, repeat Steps 10 through 12.

CHAINS

Inspection

The chain is one of the most severely stressed parts of the moped. Inspect the chain carefully whenever it is removed for cleaning. Pay particular attention to cracks in the rollers and pin and link plates (**Figure 24**). Wear on these parts will cause the chain to stretch. As a quick check of chain wear, refer to **Figure 25**. Replace the

chain if it can be pulled away from the rear sprocket by more than $\frac{1}{2}$ the length of a link.

Drive and Bicycle Chain Cleaning and Lubrication

Chain removal is accomplished by removing the master link (**Figure 26**). There are master links on both chains and removal and installation procedures are the same for both.

1. Remove the master link outer clip by prying it off with a thin bladed screwdriver.
2. Remove the outside plate and push the inside plate, complete with pins, out through the back of the chain.
3. Remove the chain and soak it in cleaning solvent for about 30 minutes to remove dirt, grease, and old chain oil. Move it around and flex it during this period so that dirt between the pins and rollers may work its way out.
4. Scrub rollers and side plates with a stiff brush, then rinse in clean solvent to carry away loosened dirt.
5. Hang the chain and allow it to dry thoroughly.
6. Lubricate the chain with a good grade of commercial chain lubricant. Follow the lubricant manufacturer's application instructions.
7. Install by reversing the removal steps. Use a new master link clip and install it with the opening facing the opposite direction of chain travel (**Figure 27**). Incorrect installation will result in the loss of the clip and may result in chain breakage.
8. After installation of old or new drive chain it is necessary to adjust the chain tension as described under *Drive Chain Adjustment* in this chapter. It is also necessary to adjust the rear brakes as described under *Brake Adjustment* in Chapter Nine. There is no adjustment necessary for the bicycle chain.

Drive Chain Adjustment

Proper chain tension is important. If the tension is too loose, the chain may skip while traveling at high speed. If tension is too tight, pedaling, engine effort and chain wear increase.

The correct chain tension is measured by pressing upon the bottom of the chain at mid-

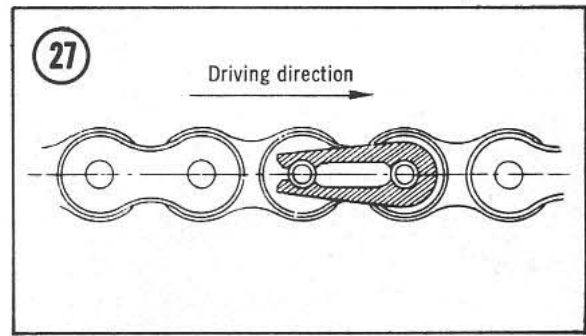
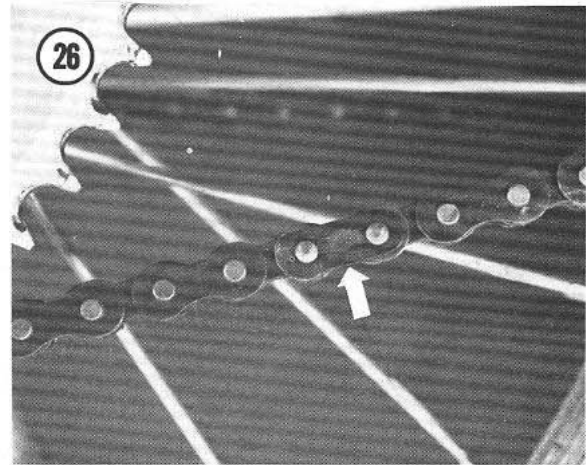

point. The slack should be $\frac{1}{2}$ inch (12.5mm). See **Figure 28**. If the tension is incorrect, use the following adjustment procedure.

1. Loosen the rear axle locknuts "A" (**Figure 29**).
2. Turn the adjusting nuts "B" (**Figure 29**), of chain tensioners, an equal amount of turns. Turning the nut *clockwise* will increase tension and *counterclockwise* will decrease tension.
3. Check to see that the wheel is aligned within the center of the chain stays.
4. Rotate the wheel to make sure the tension in the chain is constant.
5. Tighten the rear axle locknuts securely and tighten the nuts on the chain tensioners.
6. Check the rear brake operation as it may have to be adjusted. Refer to *Rear Brake Adjustment* in Chapter Nine.

Bicycle Chain Adjustment

No adjustment is necessary due to the automatic chain tensioner (similar to a bicycle derailleur).

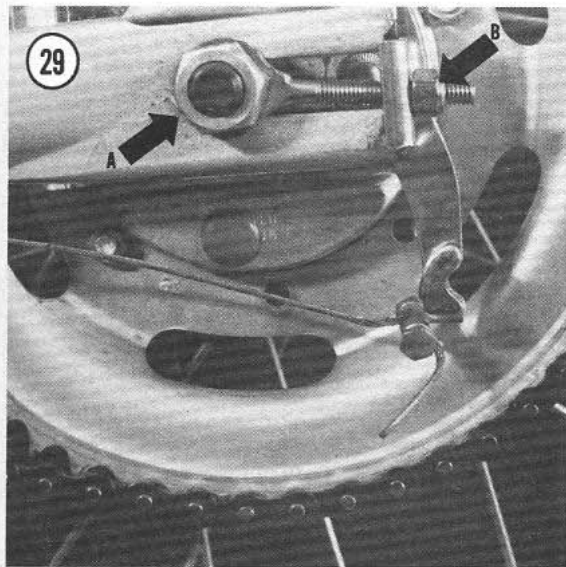
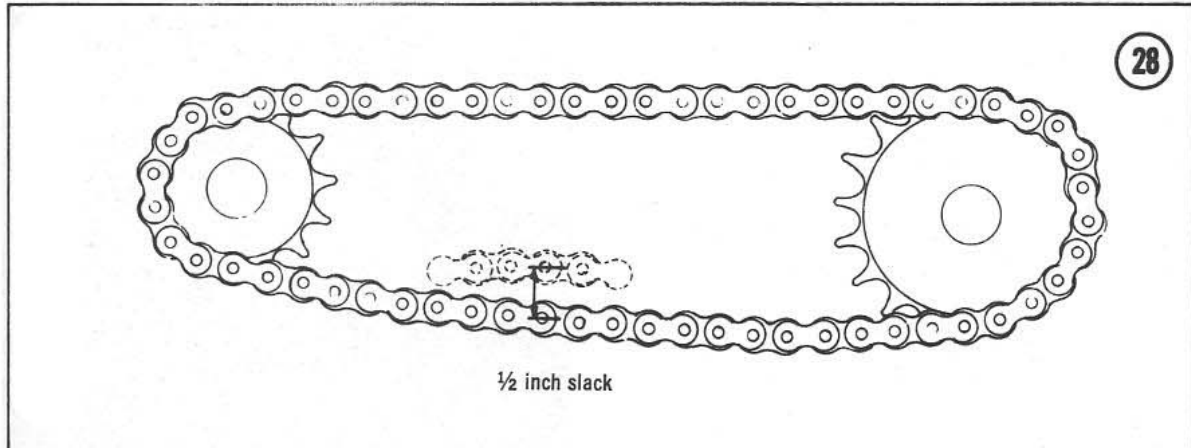

Drive Belt Tensioner

No adjustment is necessary to the drive belt since the engine mounting spring maintains the proper tension at all times.

DRIVE PULLEY

The drive pulley transmits power from the engine, via a drive belt, to the driving chain which in turn drives the rear wheel. Located on the pulley is a drive knob which disengages the pedals, if necessary, from the engine. This allows you to pedal the moped similar to a bicycle. This is handy if you should run out of gas. Do not ride the moped this way for a long period of time, or down a hill, as the drive pulley may seize on the sprocket and damage it.

For engine-powered riding the drive knob should be *out* toward the outside of the pulley (**Figure 30**), and for bicycle riding the drive knob should be *in* toward the center of the pulley (**Figure 31**).

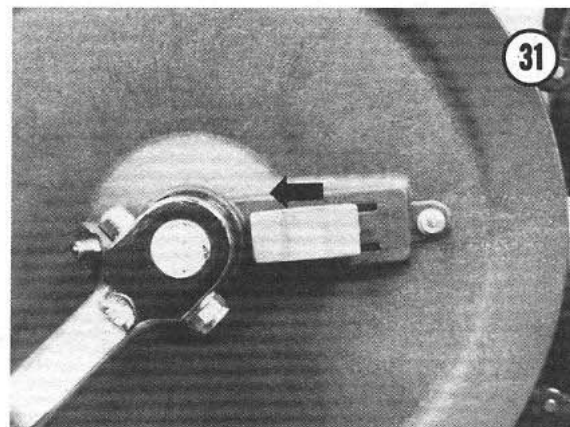
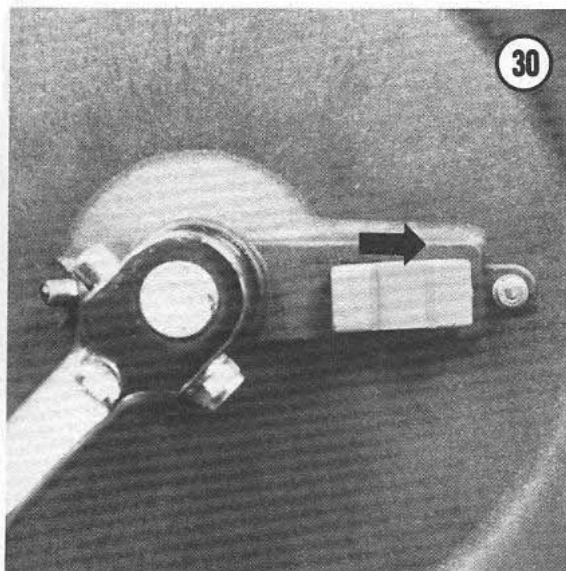

Removal/Installation

1. Remove the screws securing the left-hand engine fairing (**Figure 32**), and bolts securing the drive belt cover (**Figure 33**). Do not lose the plastic spacer used on the center bolt.
2. Pry drive belt off of groove at the bottom of drive pulley (**Figure 34**) and slowly rotate the pulley (**Figure 35**) and remove belt.
3. Remove the drive chain as described under *Drive Chain Removal/Installation* in this chapter.
4. Remove left crank arm as described under *Crank Arm Removal/Installation* in this chapter.
5. Remove outside thrust washer.
6. Pull drive pulley and sprocket off of crank axle.
7. Separate sprocket from pulley and remove bearings from pulley.
8. Inspect drive pulley and all parts attached to it. If any are broken or the pulley has any cracks, fractures, or chips, the entire unit should be replaced.
9. Repack the needle bearings with multipurpose grease prior to installation.
10. Install by reversing the removal steps. Be sure to install the sprocket with the teeth away from the back side of the pulley.

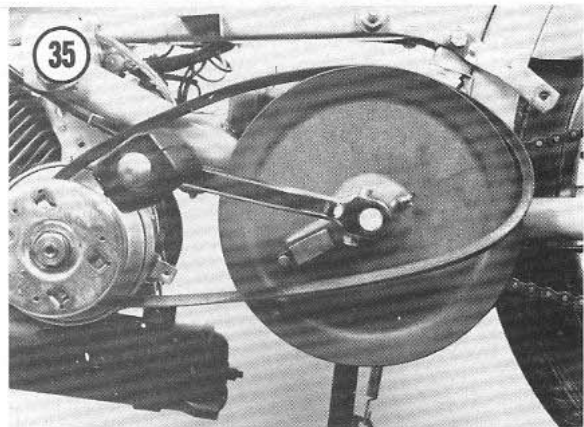
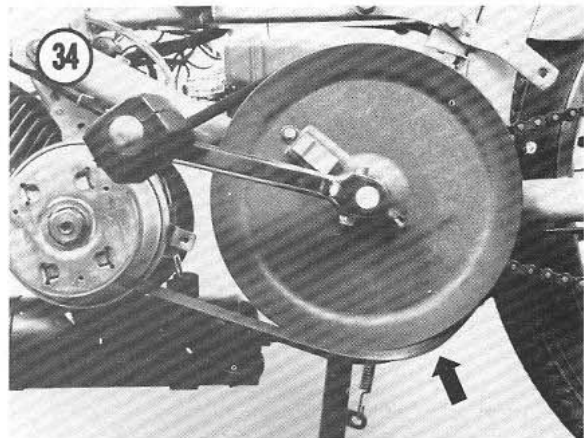
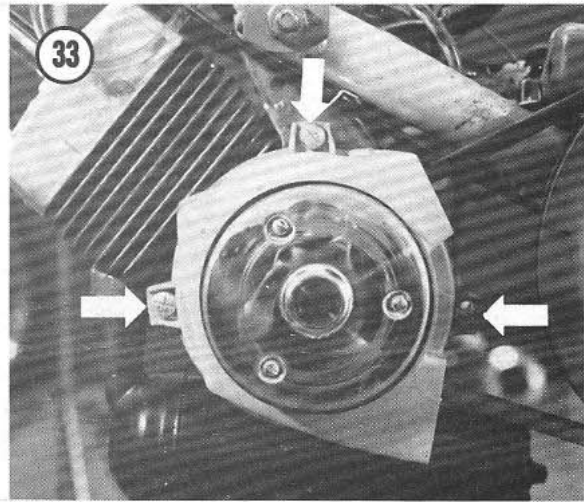
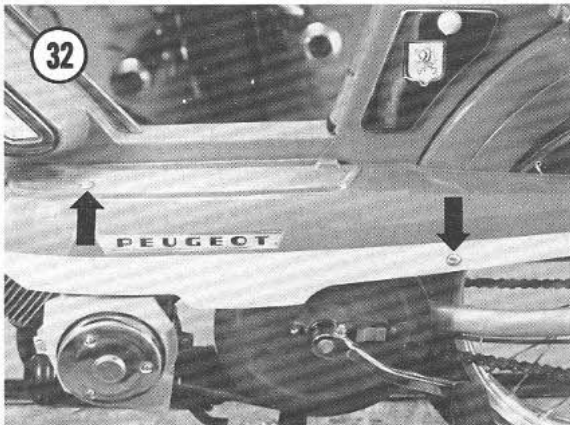

CHAPTER SEVEN

FUEL AND EXHAUST SYSTEMS

The fuel system consists of the fuel tank, which is an integral part of the frame, fuel shutoff valve, fuel filter, Gurtner carburetor, and an air filter.

The exhaust system consists of a muffler which can be taken apart for carbon removal.

This chapter includes service procedures for both fuel and exhaust systems.

CARBURETOR

The Gartner carburetor is a single barrel, side draft type that can be taken apart for service.

Removal/Installation

1. Turn the fuel shutoff valve to the OFF position and remove the fuel line from the carburetor (**Figure 1**).
2. Remove the throttle cable by unscrewing and removing cable from anchor bolt (**Figure 2**).
3. Remove choke cable by unscrewing and removing the cable from the anchor bolt (**Figure 3**).
4. Loosen, but do not remove, the bolt on the clamp securing the carburetor to the intake manifold (**Figure 4**).

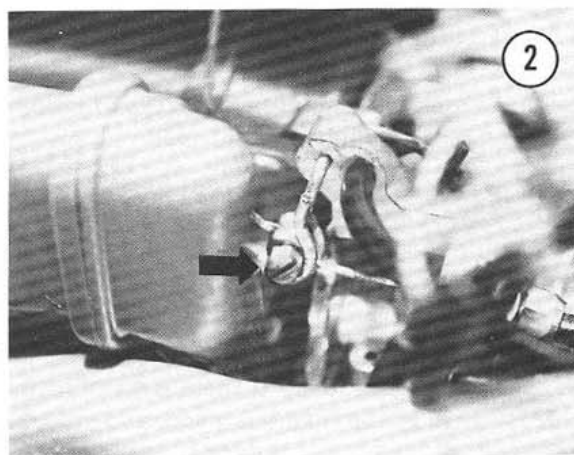
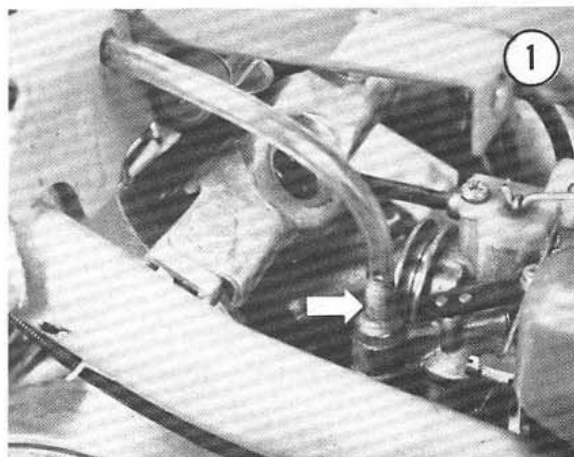

5. Remove the carburetor and air filter from the intake manifold by pulling them off of the intake manifold toward the rear of the moped.

6. Install by reversing the removal steps, be sure to use a new gasket between the carburetor and intake manifold.

Overhaul

It is difficult to determine exactly how often a carburetor should be overhauled. As a rule of thumb, it is a good idea to overhaul the carburetor every time the engine is decarbonized. If your moped is used in dusty conditions, the overhaul should be performed more often.

Disassembly/Assembly

1. Remove the screw at back of air filter (Figure 5).
2. Remove the top mounting strap screw securing carburetor to air filter (Figure 6) and remove air filter.
3. Remove top cover (Figure 7).
4. Remove float (Figure 8) from bowl.
5. Remove screw (Figure 9) securing slide assembly to carburetor body and remove slide assembly (Figure 10).
6. Remove idle adjustment screw "A" and jet "B" from carburetor body (Figure 11).
7. Remove the plug on the bottom of the cover and remove the fuel filter (Figure 12).
8. Assemble by reversing the disassembly steps using new gaskets.

Cleaning

1. Clean all parts except the float, fuel filter, and gaskets in a good grade of carburetor cleaner. Follow the manufacturer's instructions for correct soaking time (usually about ½ hour).
2. Remove parts from cleaner and blow dry with compressed air. Blow out the jet with compressed air. *Do not* use a piece of wire to clean it, as minor gouges in the jet can alter the flow rate and upset the fuel/air ratio.
3. Shake the float to see if there is gasoline inside. If there is, the float has a leak and must be replaced.

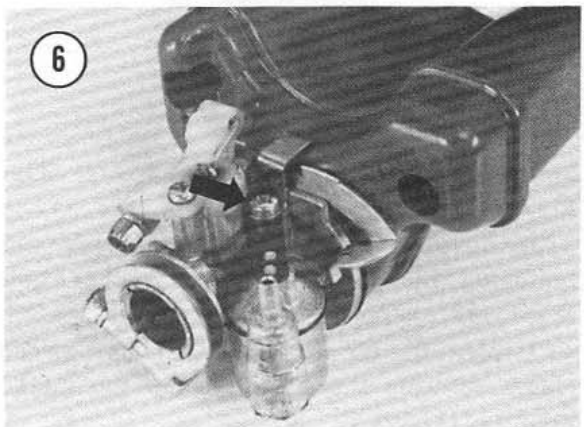
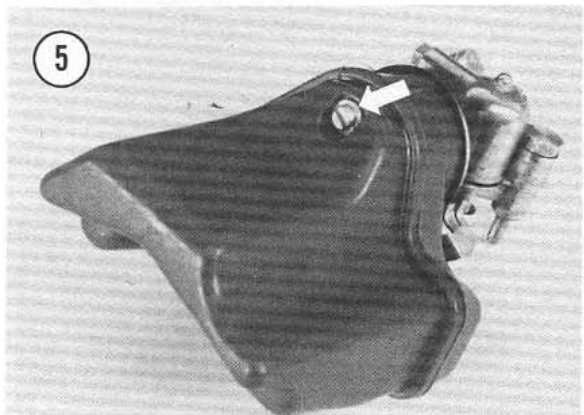
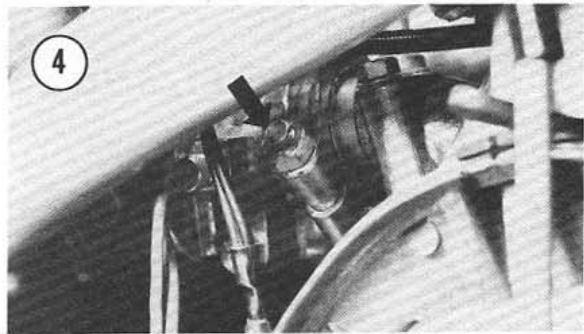
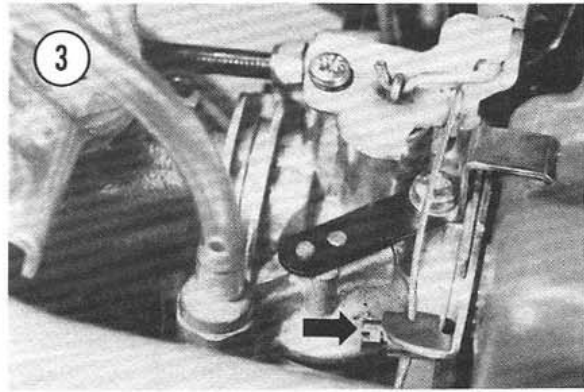

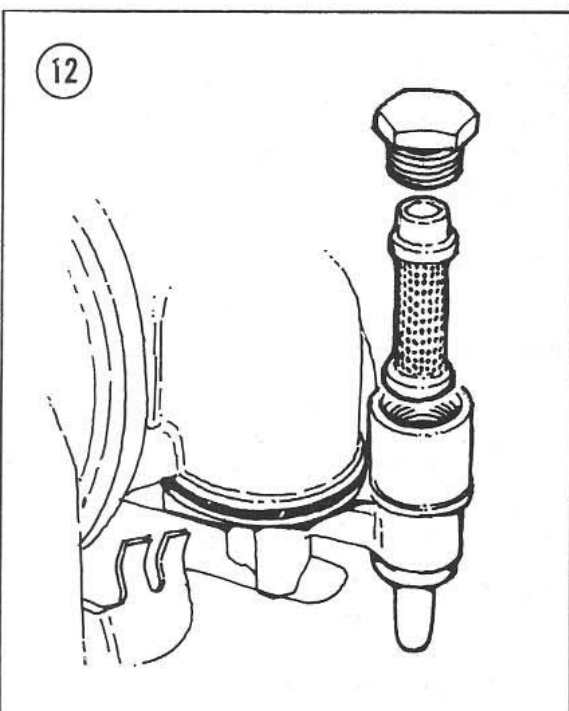
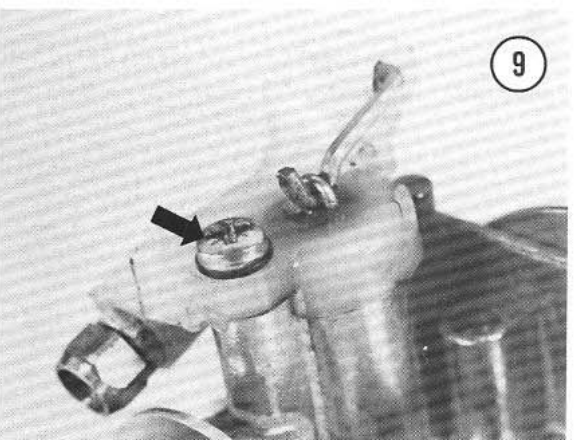
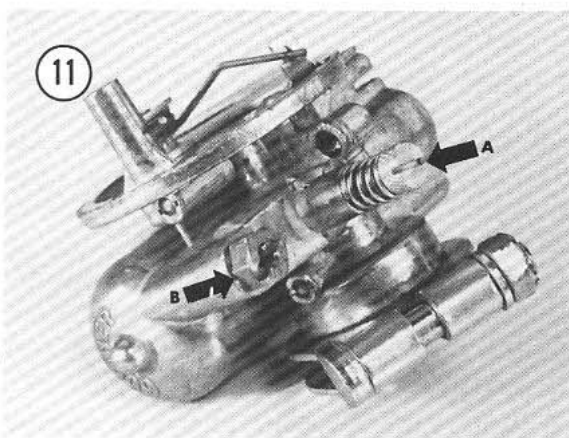
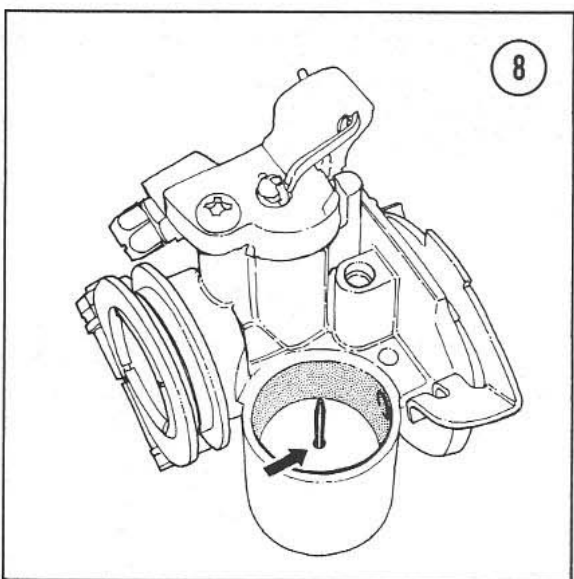
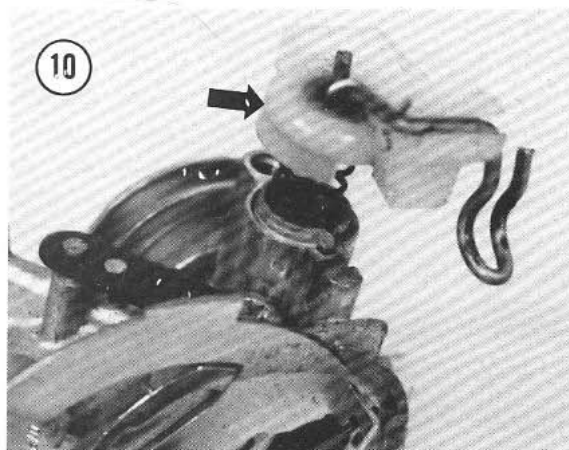
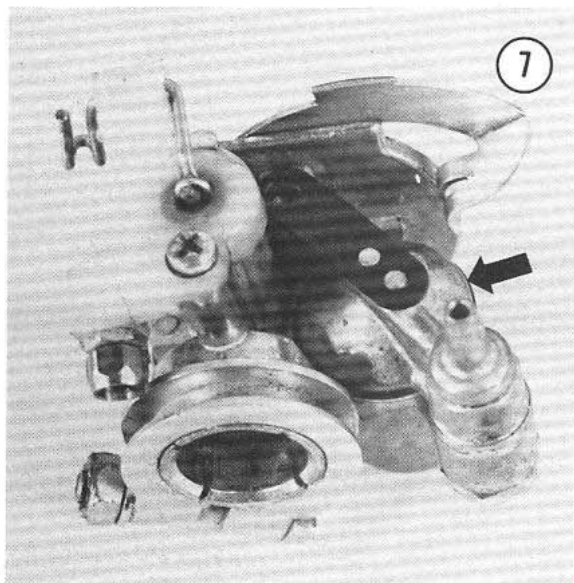

Fuel Filter**Removal/Installation**

The fuel filter can be removed without removing the carburetor. Unscrew the plug and remove the filter (**Figure 12**). Clean out the filter with a medium soft toothbrush and blow out with compressed air. If filter is cracked or broken, it should be replaced.

Install by inserting the filter up into the carburetor and replacing the plug securely.

FUEL SHUTOFF VALVE**Removal/Installation**

1. Turn the shutoff valve to the OFF position (**Figure 13**).
2. Remove the flexible fuel line from the carburetor (**Figure 14**) and place the loose end into a clean, sealable metal container. This fuel can be reused if it is kept clean. Do not drain it into your gasoline can as this fuel already has engine oil added to it.
3. Open the fuel valve to the RESERVE position and remove the fuel fill cap. This will allow air to enter the tank and speed up the flow of fuel. Drain the tank completely.
4. Remove the fuel shutoff valve by unscrewing it with a wrench.
5. After removing the valve, insert a corner of a shop rag into the opening in the tank to stop the dribbling of fuel onto the frame.
6. Clean out the filter with a medium soft toothbrush and blow out with compressed air. Replace if any part is defective.
7. Install by reversing the removal steps.

AIR FILTER**Removal/Installation**

1. Loosen but do not remove, the bolt on the clamp securing the carburetor to the intake manifold (**Figure 15**).
2. Remove the carburetor and air filter by pulling it off the manifold toward the rear of the moped.
3. It is not necessary to remove the throttle and choke cables.
4. Remove the screw at the back of the air filter (**Figure 5**).

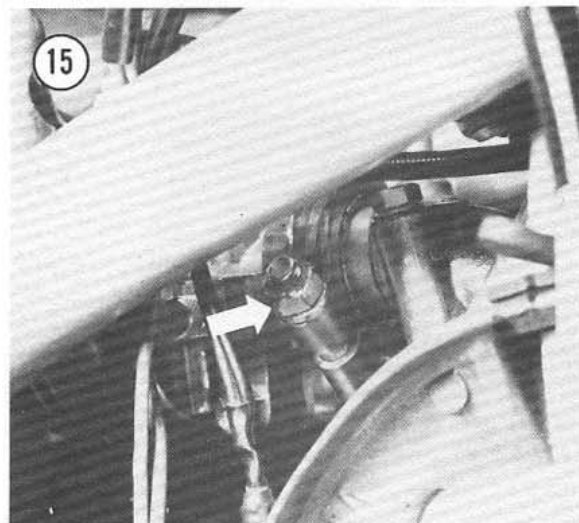
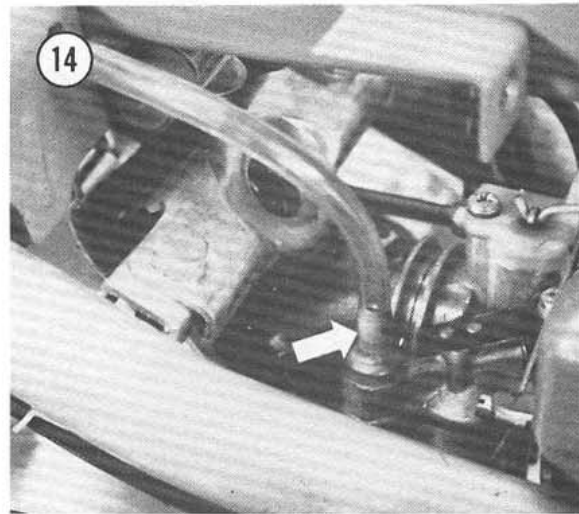
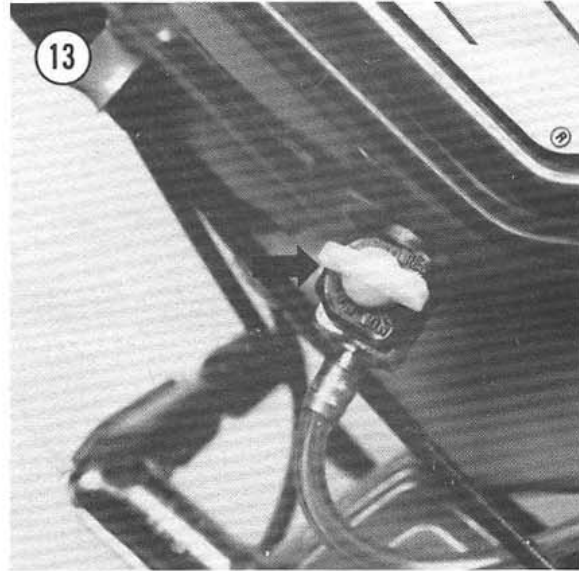

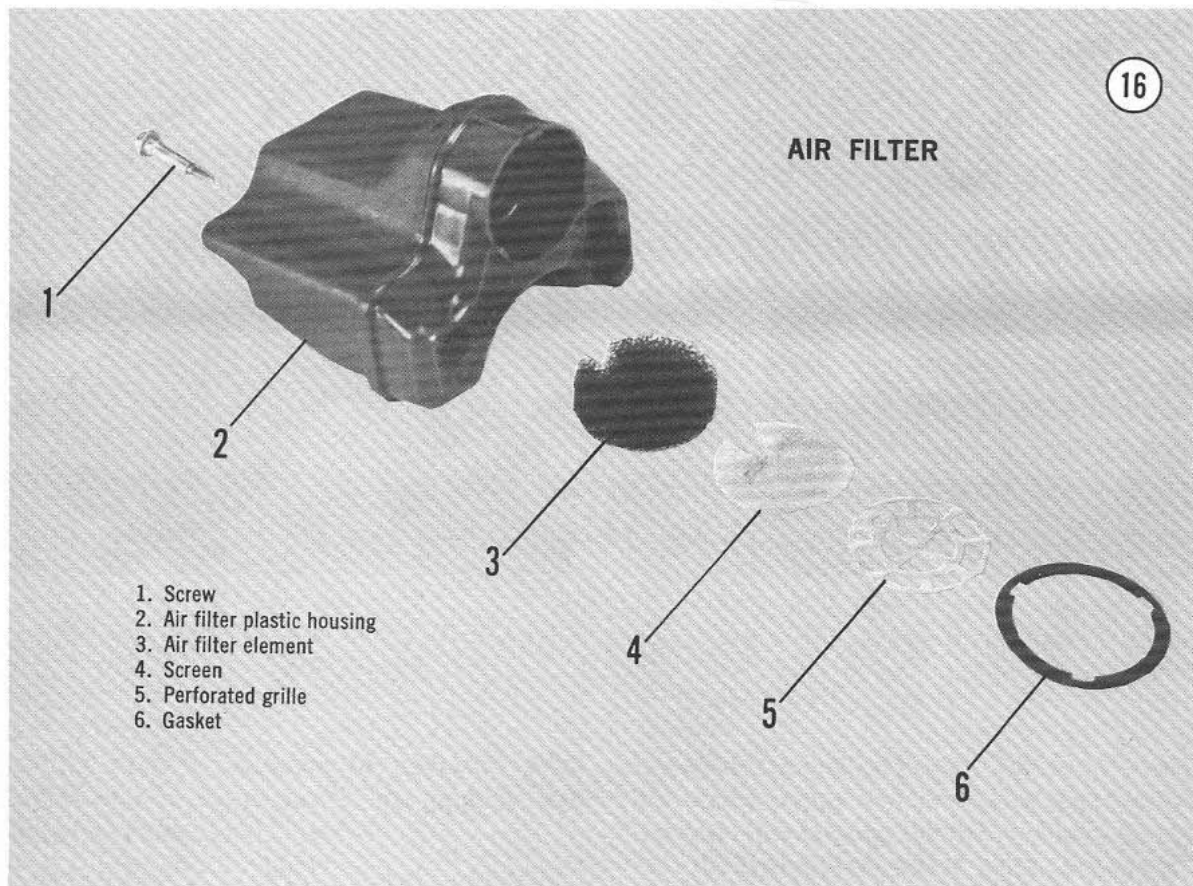

1. Screw
2. Air filter plastic housing
3. Air filter element
4. Screen
5. Perforated grille
6. Gasket

5. Remove screw at top of air filter (**Figure 6**), remove air filter from carburetor and replace screw to keep the carburetor cover in place.

6. Pull out the perforated grill, screen, and air filter element from throat of the air filter (**Figure 16**).

7. Wash the element out in cleaning solvent and squeeze dry in a clean cloth.

8. Remove all foreign matter from inside the plastic housing.

9. Wash the inside and outside of the housing in cleaning solvent and thoroughly dry with a clean cloth or compressed air.

10. Thoroughly saturate the air filter element in lightweight oil and squeeze out in a clean cloth.

11. Install by reversing the removal steps. When installing the perforated grill and screen, make sure that the notch is at the bottom to align with the rib in the housing. Replace the gasket between the air filter and the intake manifold.

EXHAUST SYSTEM

The muffler is a very important part of the 2-cycle engine in regard to operating performance. It must be cleaned periodically to remove the normal carbon buildup. This is described under *Muffler Decarbonizing* in Chapter Three.

Make sure that the fitting securing the muffler to the cylinder is tight at all times. If it is loose, it will decrease engine performance and may cause damage to the piston and valve system.

Muffler Removal/Installation

1. Unscrew the fitting (**Figure 17**) securing the muffler to the cylinder.

2. Remove the bolt, lockwasher, and nut securing the muffler to the frame mounting bracket (**Figure 18**) and remove the muffler.

3. Install by reversing the removal steps, using a new ring gasket between the muffler and the cylinder.

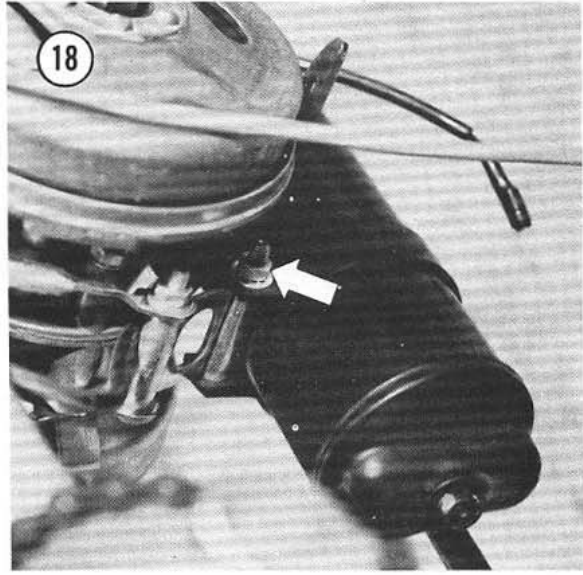
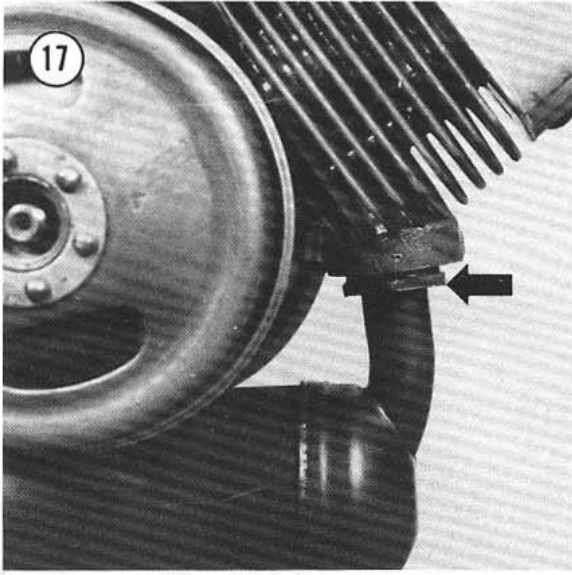

CHAPTER EIGHT

ELECTRICAL SYSTEM

This chapter discusses the operating principles and maintenance of the ignition and lighting systems.

MAGNETO

The engine-mounted magneto generates electricity for the lights and spark plug. It works similar to a generator or alternator on an automobile, but is more compact and is attached directly to the engine.

The stator is stationary and consists of two coils of specially wound wire attached to the engine crankcase. The rotor has built-in permanent magnets which rotate with the engine crankshaft. As the magnets move past the stationary coils, they induce a voltage within these coils which powers the lights, horn, and spark plug.

The ignition breaker points, in the magneto, are used to regulate current flow from the ignition coil to the spark plug, at just the right time, when the piston reaches firing position. This is called *Magneto Ignition Timing*. When the breaker points are closed the current is grounded, thus no current to the spark plug. When they open the current that has built up in the coil, it is no longer grounded and is allowed to flow from the coil directly to the spark plug,

bypassing the breaker points. This sudden burst of current jumps the spark plug gap creating the spark for igniting the fuel mixture. To prevent the points from arcing when they open, a condenser is placed in the circuit.

Figure 1 illustrates the breaker points and condenser in the ignition circuit leading to the spark plug. Electrical wiring diagrams are at the end of this chapter.

Removal/Installation

1. Remove the 2 screws securing the right-hand engine fairing and remove fairing (**Figure 2**).

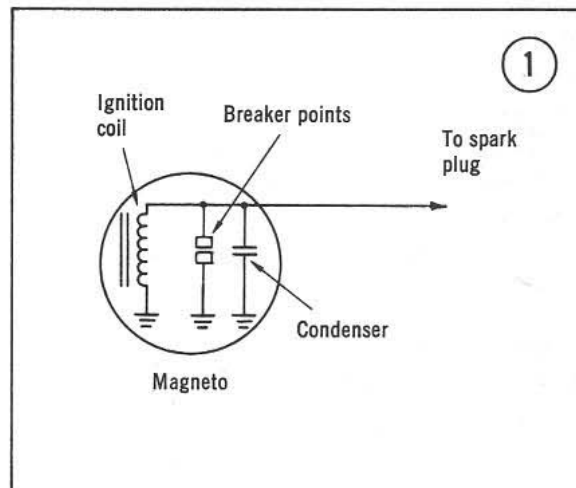

- Remove the chrome magneto cover by pulling both rubber straps from the nylon lugs on the cover (**Figure 3**).

NOTE: *The following procedure requires 2 people to remove the rotor.*

- Remove the nut securing the rotor with an impact driver while your helper holds the rotor to keep it from turning (**Figure 4**).
- Remove the rotor with a flywheel puller (**Figure 5**). Screw the outer body of the puller into the rotor until it stops. Screw the inner thrust bolt in all the way until it stops. Hold the outer body stationary with a 21mm wrench and turn the inner bolt with a 17mm socket or wrench until the rotor disengages from the crankshaft (**Figure 6**). Remove the rotor.
- Unscrew the black plastic cap and the spark plug wire from the radio suppressor at the spark plug (**Figure 7**).
- Remove the 2 machine screws and lock-washers securing the stator to the crankcase (**Figure 8**).
- Install by reversing the removal steps. When installing the stator make sure that the spark plug lead is located at the *top*.
- Install the nut securing the rotor with the bevel side *in*; there is no washer. Use an impact driver for the final tightening of the nut.

Condenser Removal/Installation

- Remove the magneto rotor as described under *Magneto Removal/Installation* in this chapter.
- Pull lubricating felt pad out of retaining clip (**Figure 9**).
- Remove screw under pad securing pad clip and condenser. Remove wires from condenser and remove condenser.
- Install by reversing removal steps.

Breaker Points Removal/Installation

- Remove the magneto rotor as described under *Magneto Removal/Installation* in this chapter.

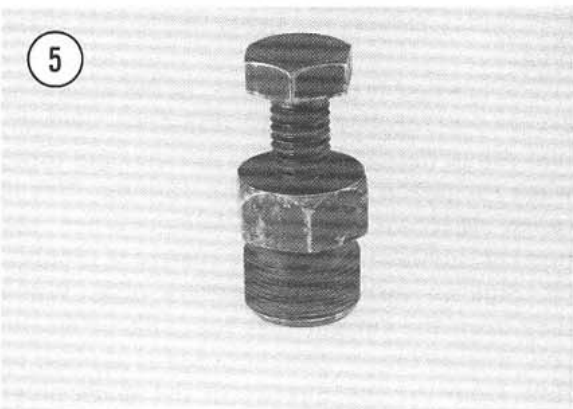
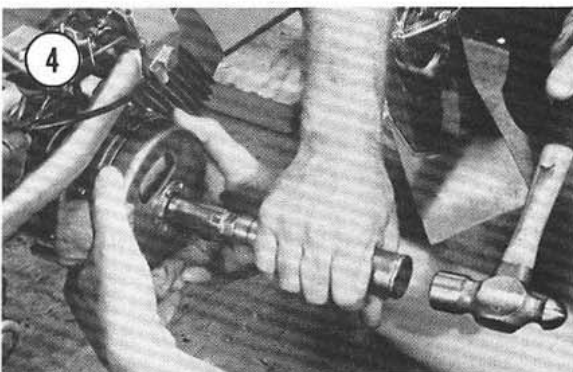
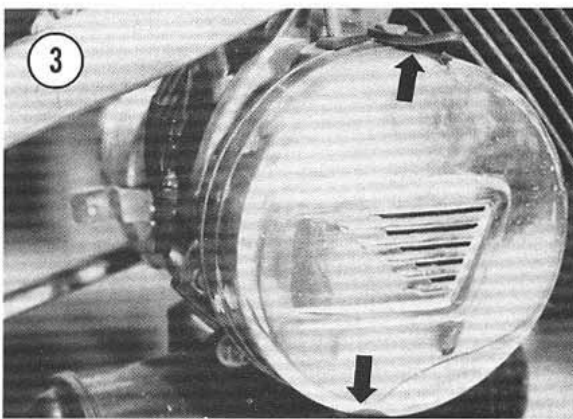

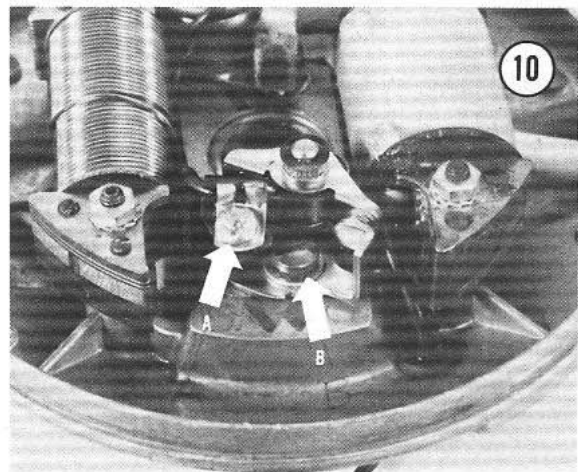
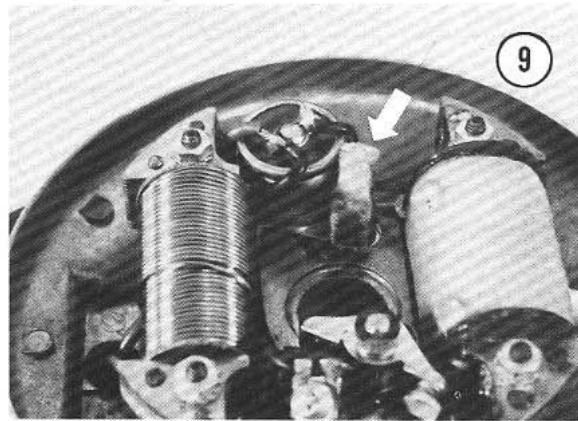
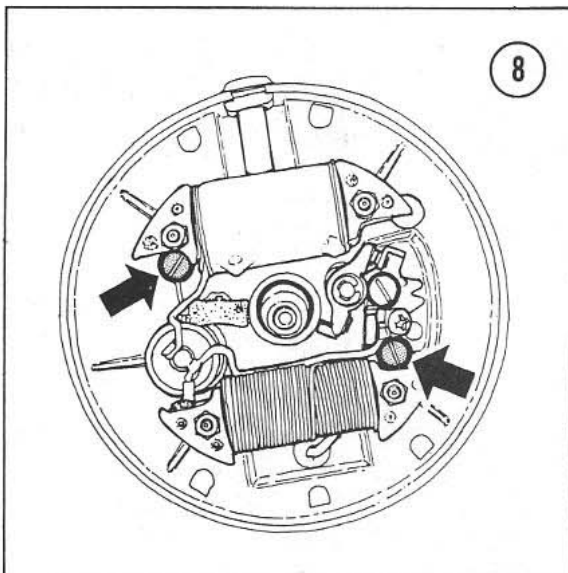
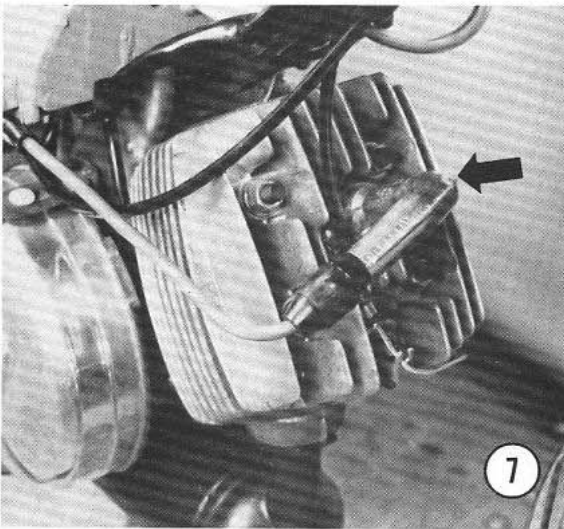
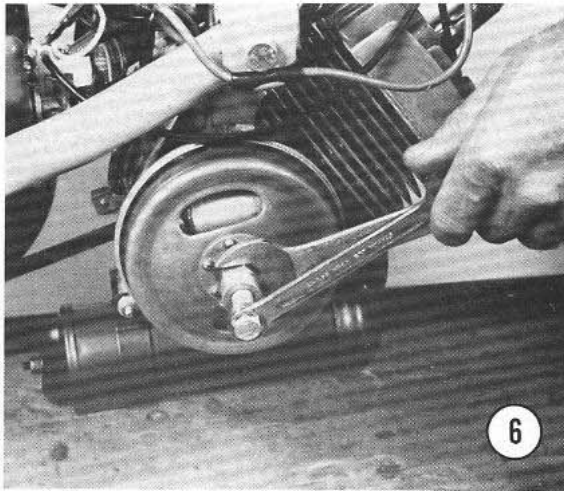

2. Remove sheet metal screw "A" attaching electrical terminal and screw "B" securing point assembly to stator (Figure 10).

3. Install by reversing the removal steps and adjust timing as described under *Magneto Ignition Timing* in Chapter Three.

8

ACCESSORIES & INSTRUMENTS

Power for the lighting system is provided by the magneto. The electrical system consists of:

- a. Headlight
- b. Taillight/brakelight combination
- c. Speedometer illumination light
- d. Horn
- e. Switches for the ignition, lights, brakes, and horn

Table 1 lists the bulb numbers for replacement.

Table 1 LIGHT BULB REPLACEMENT

Light	Type
Headlight	Sealed beam 6 Volt, 20 Watt
Taillight/stoplight	BA-15D 6 Volt, 1.8 Watt double element
Speedometer light	E-10 6 Volt, 0.6 Watt single element

HEADLIGHT

The headlight unit consists of a lamp housing, chrome trim bezel, and a sealed beam dual element bulb. The headlight switch is located on the left side of the handlebar.

Replacement

1. Remove screw at bottom of chrome trim bezel (**Figure 11**).
2. Pull out on the bottom of the lens and chrome trim bezel and pull up and away from the base.
3. Disconnect the electrical wires from the terminal on the back side of the sealed beam bulb.
4. Remove retaining clips that secure the sealed beam into the chrome trim ring, with a screwdriver (**Figure 12**).
5. Check the rubber grommet, at the back of the base, for cracks or deterioration; replace if necessary.
6. Install by reversing the removal steps.

Adjustment

This procedure is best accomplished at night or at dusk.

1. On a garage door or flat wall, stick a 12 inch piece of masking tape to it horizontally 19¼ inches up from the ground.
2. Place the moped so the front of the headlight is 33 feet back from this surface and pointed directly at it.
3. Sit on the moped with the centerstand raised.
4. Turn the headlight ON. It should hit directly on this line. If not, loosen the adjusting bolts (**Figure 13**), one on each side of the headlight, and rotate the light assembly with your hands until it is correct.
5. Tighten the adjusting bolts securely.

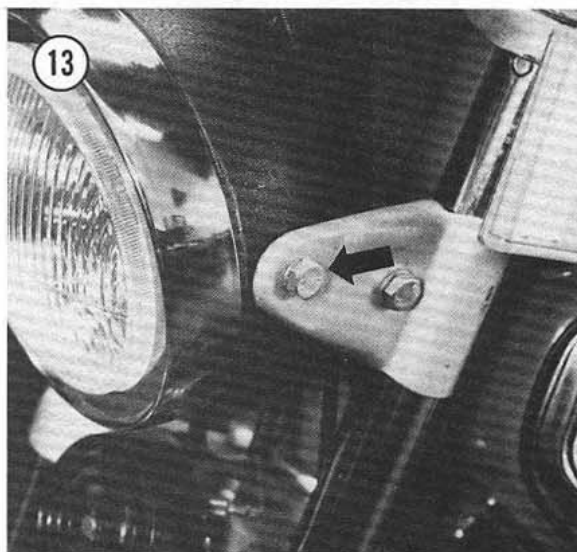
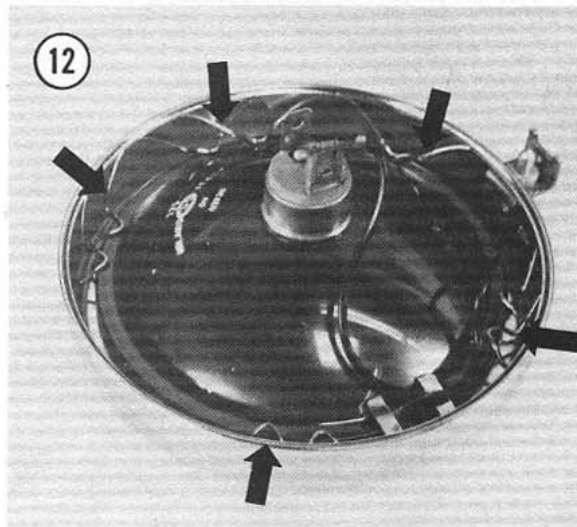
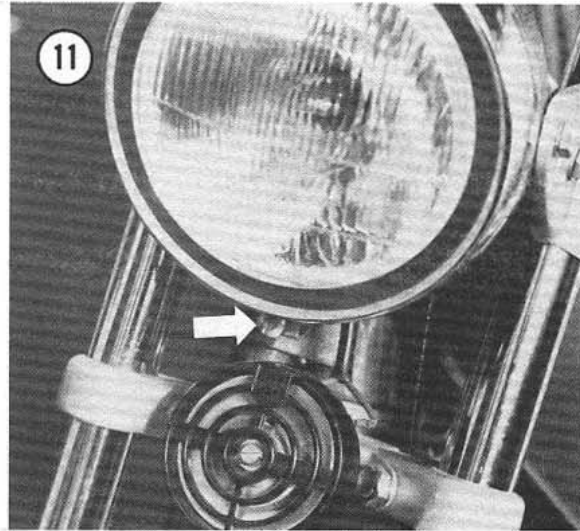

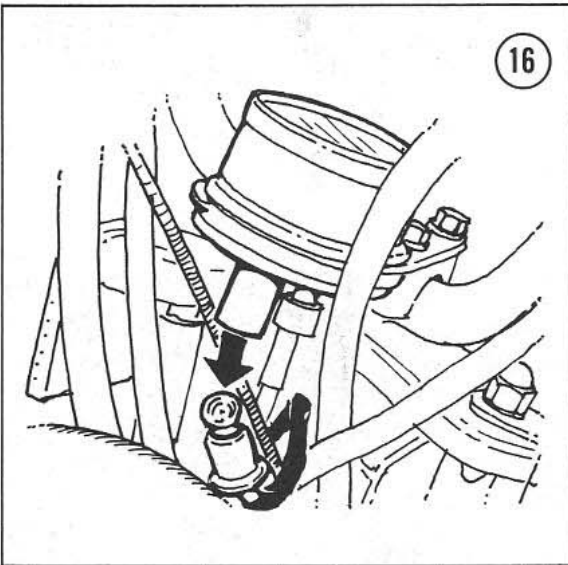
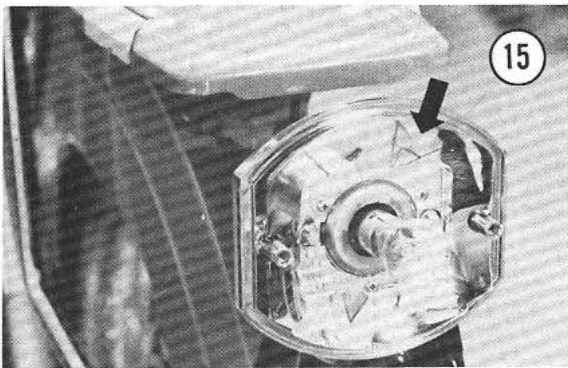
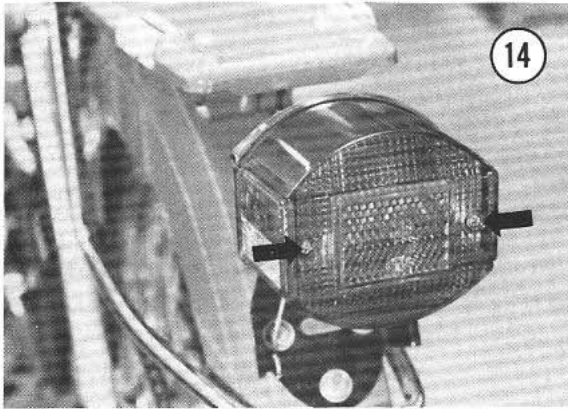

TAILLIGHT/BRAKELIGHT

Replacement

1. Remove the 2 lens attachment screws (**Figure 14**), and remove the lens.
2. Push the bulb in slightly and twist it counterclockwise and remove.

3. If necessary, clean the 2 contact points, at the base of the bulb socket, with a small piece of 180 grit sandpaper wrapped over the end of a pencil.
4. Wash out the inside and outside of the lens with a mild detergent and wipe dry.
5. Wipe off reflective base surrounding the bulb with a soft cloth (**Figure 15**).

CAUTION

This part is chrome plated plastic — do not use an abrasive to clean it as it will scratch and dull the surface thus reducing the effectiveness of the taillight.

6. Check the sealing gasket and rubber grommet for cracks or deterioration, replace if necessary.
7. Install by reversing the removal steps. Be sure to install the gasket.

SPEEDOMETER ILLUMINATION LIGHT

The bulb illuminates the speedometer for night use. It is turned on with the headlights.

Replacement

Pull the bulb support down and out of the speedometer housing (**Figure 16**). Remove and replace the bulb.

SWITCHES

Brakelight

The switches are located at the base of each brake hand grip on the handlebar. The brakelight will go on when either the front or rear or both brakes are applied.

Removal/Installation

1. Pull back rubber boot (**Figure 17**).
2. Pull electrical connectors off of switch terminals.
3. Unscrew locknut and switch from hand lever base.
4. Install by reversing the removal steps. Make sure the switch is screwed in all the way before

tightening the locknut. If rubber boot is deteriorated it should be replaced at this time.

Headlight, Horn, and Cutoff Removal/Installation

Remove the screw on the underside of the clamp securing the clamp to the handlebar (**Figure 18**). Remove switch and electrical leads. Prior to removal, follow the path of the electrical leads through the frame. Make a sketch and be sure they are replaced exactly the same way. Do not allow any electrical leads to come in contact with the engine as the heat will melt the insulation and eventually short out the wire.

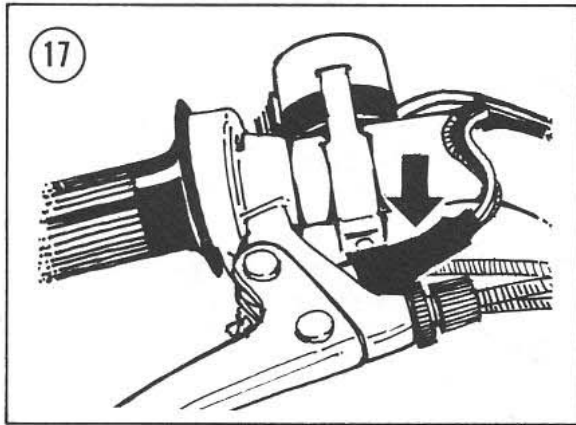

HORN

The horn operates on electricity supplied by the lighting coil of the magneto and is operated by the horn button located by the left-hand grip.

Removal/Installation

Remove the 2 electrical connections from the terminals on the horn. Remove bolt and nut securing horn bracket to fork lower bracket (**Figure 19**) and remove the horn bracket. Install by reversing the removal steps; make sure the electrical connections do not touch any metal parts.

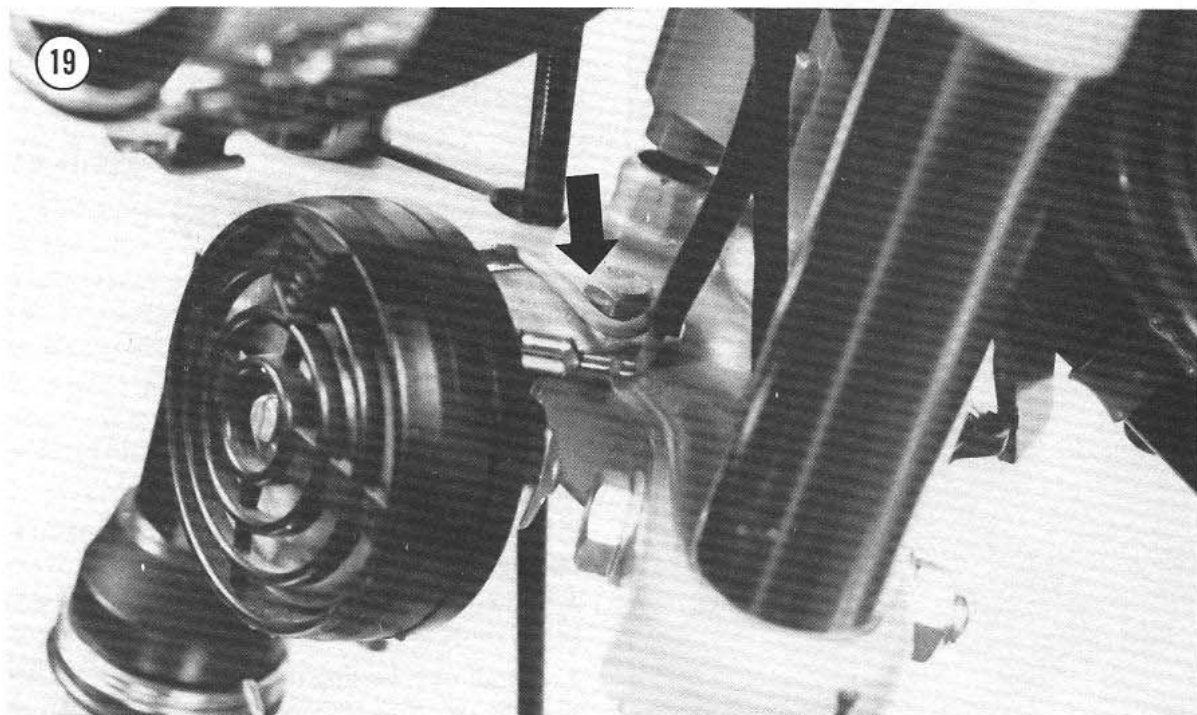
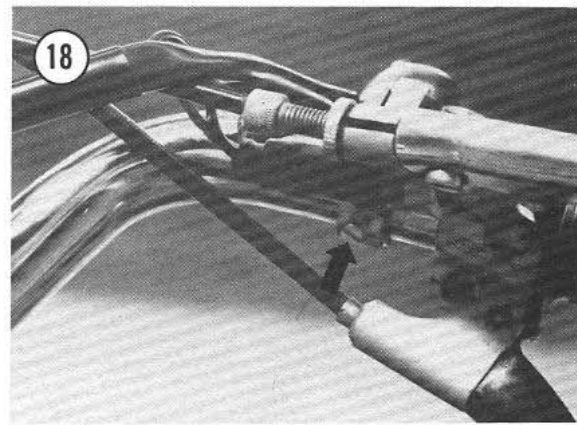

ELECTRICAL WIRING DIAGRAM  ground  white

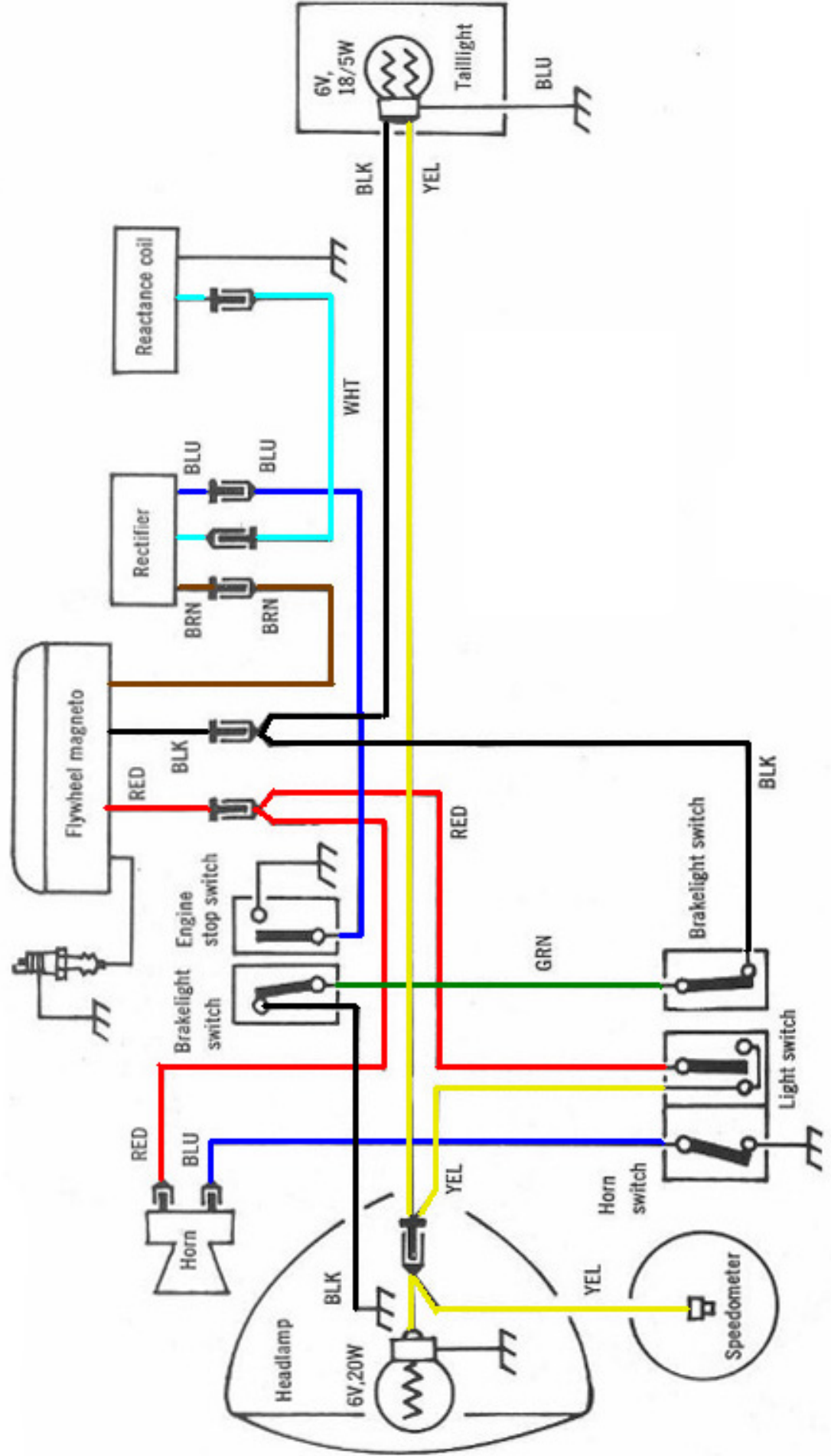

IGNITION WIRING DIAGRAM

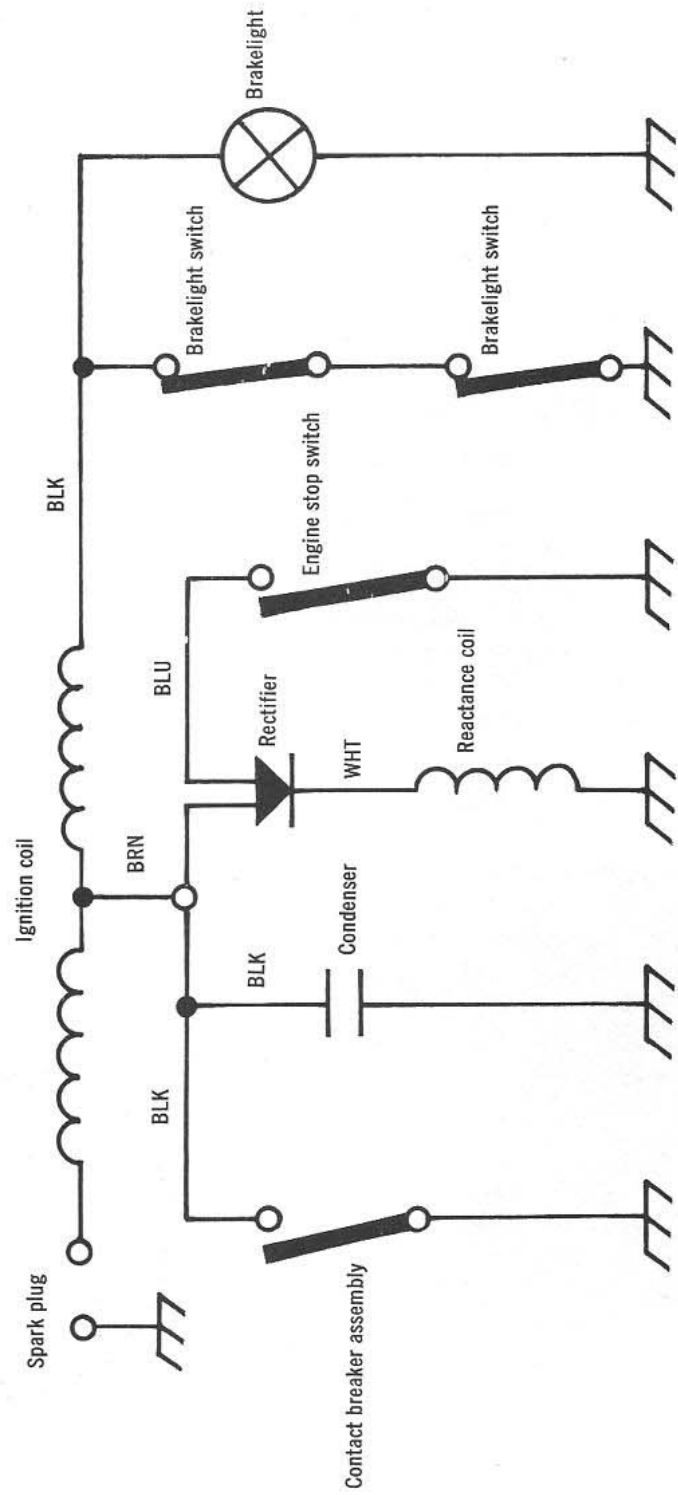

CHAPTER NINE

BRAKES

Figure 1 illustrates the major parts of the brakes. Squeezing the brake lever, on the handlebar, rotates the cam which in turn forces the brake shoes out into contact with the brake drum.

BRAKE CABLE

Brake cable adjustment should be checked periodically as the cables stretch out with use and increase brake lever free play. Free play is the distance the brake lever travels between the released position and the point when the brake shoes come in contact with the drum. This should be kept to a minimum.

Adjustment

1. Loosen the locknut "A" and turn the adjusting barrel "B" clockwise to reduce slack in the cable (**Figure 2**).
2. If the cable has stretched enough that this adjustment is not enough, the cable will have to be adjusted at the brake drum.
3. Screw the adjusting barrel "B" all the way in toward the hand grip.
4. Remove the cable and anchor bolt from the brake arm (**Figure 3**) by pushing on the arm and slipping the bolt and cable out.

5. Mark the lower anchor bolt position on the cable with a piece of masking tape. Loosen the bolt and slip it *up* the cable about $\frac{1}{4}$ to $\frac{1}{2}$ inch and tighten the bolt.
6. Reinstall the cable and anchor bolt in the brake arm and retest at the hand grip.
7. Repeat Step 5 if necessary.

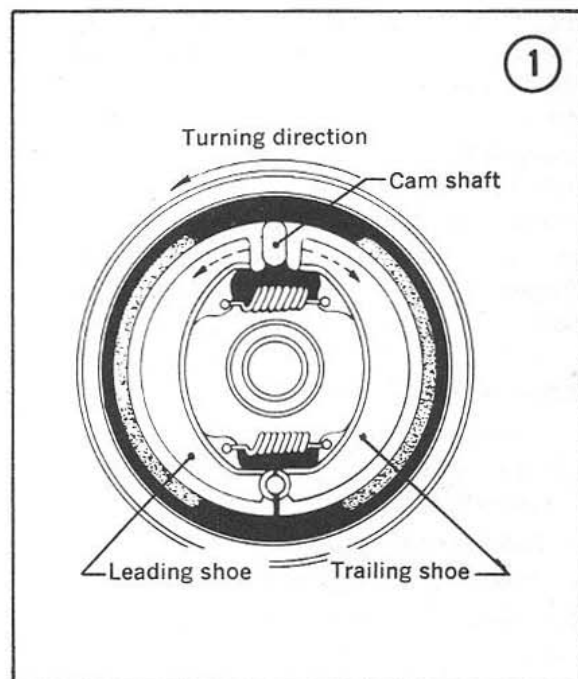

Removal/Installation

In time the cable will stretch to the point where it is no longer useful and will have to be replaced.

1. Remove the cable anchor bolt from the brake arm (**Figure 3**) by pushing on the arm and slipping the bolt and cable out.
2. Loosen the locknut "A" and completely unscrew adjusting barrel "B" (**Figure 2**) from the hand lever.
3. Pull the hand lever all the way back to the grip, unscrew and remove the socket bolt (**Figure 4**) and pull the cable barrel end out.
4. Remove the cable from the frame.

NOTE: Prior to removal of cable, make a drawing of the routing of the cable through the frame. It is very easy to forget how it was, once it has been removed. Replace it exactly as it was, avoiding any sharp turns.

5. Install by reversing the removal steps, adjusting the brakes as described under *Brake Adjustment* in this chapter.

BRAKE LINING

Inspection

Both the front and rear wheel hubs have inspection holes (**Figure 5**) to check the brake lining thickness without removing and disassembling the hubs.

For removal, pry out the plastic inspection plugs with a screwdriver and install by pushing them in with your thumb.

The brake lining should be replaced if worn within $\frac{1}{32}$ in. (0.8mm) of the metal shoe table (**Figure 6**). This is measured at the thinnest part.

Removal/Installation

1. Remove front and/or rear wheel as described under *Front or Rear Wheel Removal/Installation* in Chapter Ten.
2. Pull brake assembly off of hub.
3. Remove the brake shoe assembly (**Figure 7**), including the return springs from the brake plate. Pry each shoe from the brake plate (**Figure 8**) using a screwdriver or similar tool.

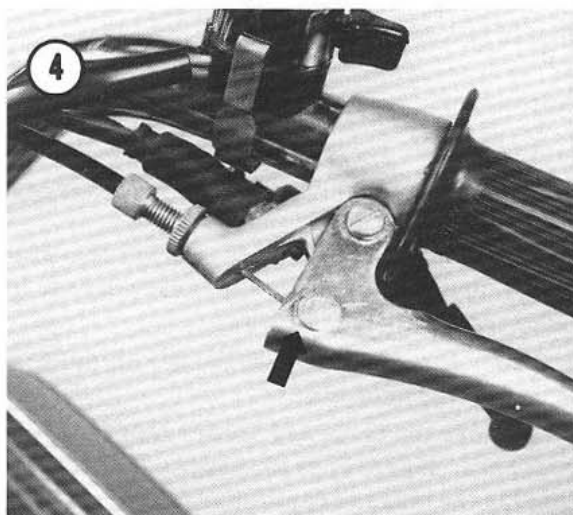
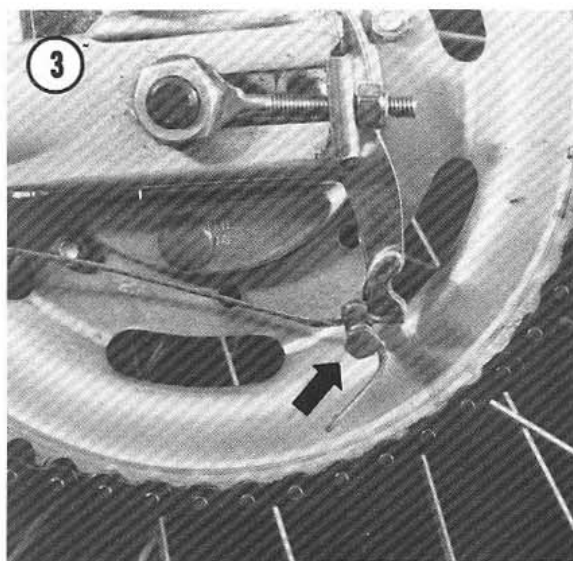
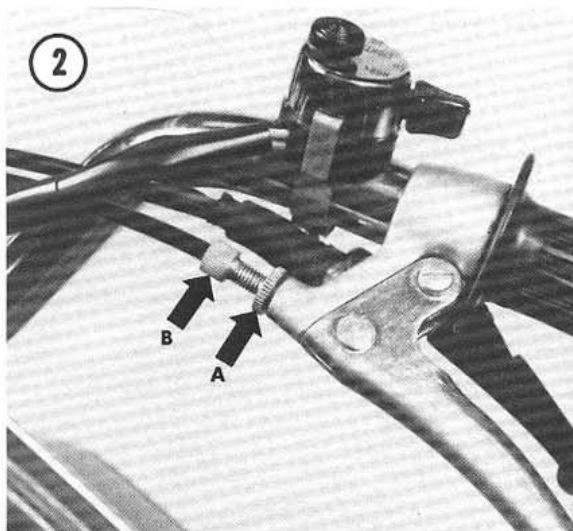

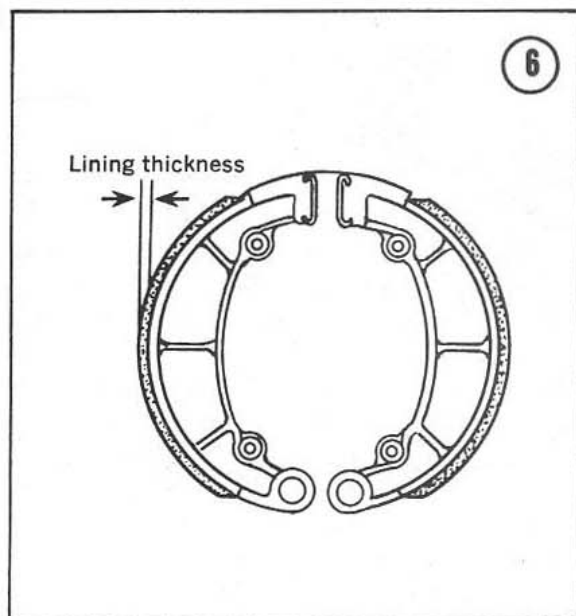
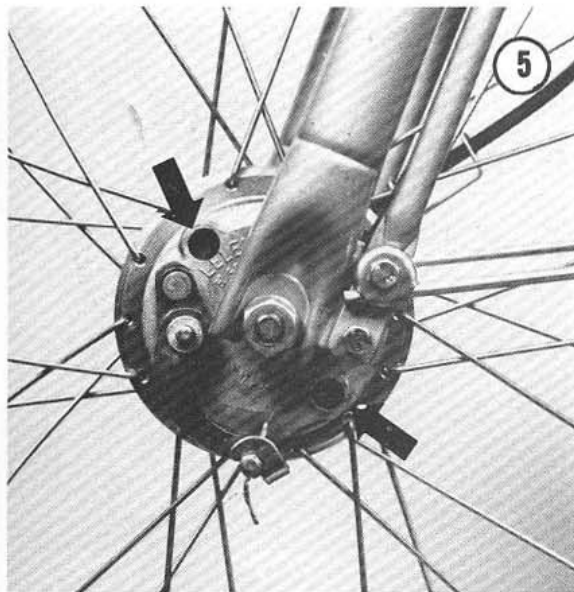

4. Inspect the linings for any traces of oil or grease. If they are contaminated, they should be replaced. Dirt imbedded in the lining may be removed with a wire brush.

5. The linings should be replaced if worn within $\frac{1}{32}$ in. (0.8mm) of the metal shoe table (**Figure 6**). Measure it at the thinnest part.

6. Check the cam and pivot pin for wear and corrosion. Clean off any corrosion with fine emery cloth. Check that the cam rotates freely. If cam or pivot pin is worn, the brake plate should be replaced.

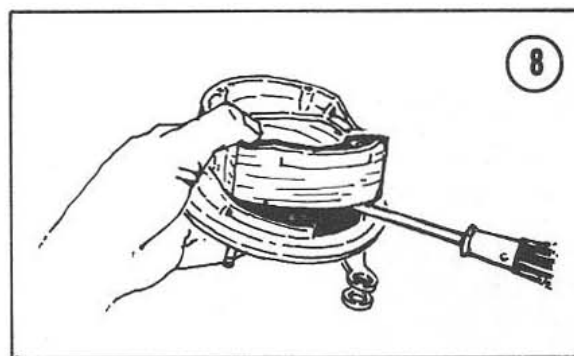
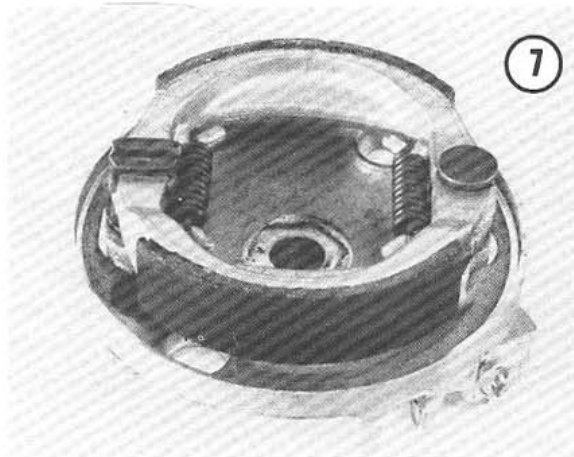

7. Inspect the brake return springs for wear. If they are stretched, they will not fully retract the brake shoes and they will drag and wear out prematurely. Replace if necessary.

8. Install by reversing the removal steps. Apply a light coat of grease to the cam and pivot pin. Avoid getting any grease on the brake plate where the linings may come in contact with it. Hold the shoes in a V formation with the springs attached and snap them in place on the brake plate.

BRAKE DRUM

Removal/Installation and Inspection

1. Remove front and/or rear wheel as described under *Front or Rear Wheel Removal/Installation* in Chapter Ten.
2. Pull the brake assembly out of hub.
3. Inspect the drum for deep grooves, roughness, or scoring. Replace if necessary.
4. Install by reversing the removal steps.

CHAPTER TEN

SUSPENSION AND FRAME

This chapter discusses service and repair of wheels, tires, steering, and suspension.

FRONT WHEEL

Removal/Installation

1. Place moped on centerstand.
2. Pull speedometer cable out of drive unit (**Figure 1**).
3. Disconnect the brake cable by pushing the brake arm upward and unhook the cable stop (**Figure 2**).
4. Loosen the axle locknuts and remove the wheel (**Figure 3**).
5. Install by reversing the removal steps. Position the speedometer drive unit to align with the cable before tightening the axle locknuts.

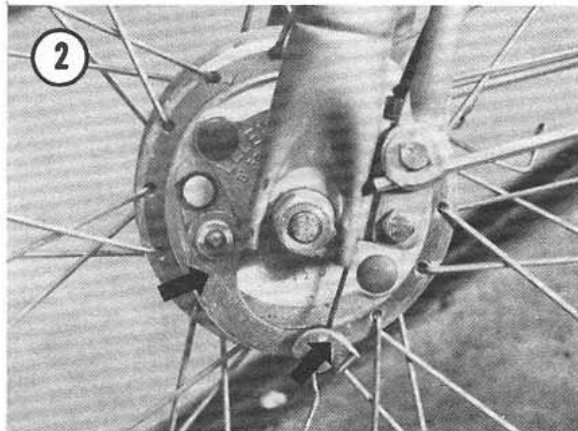
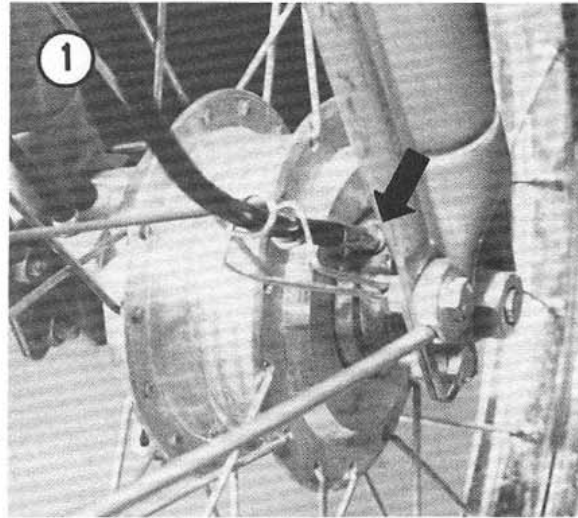

REAR WHEEL

Removal/Installation

1. Disconnect the rear brake cable by pushing the brake arm forward and unhooking the cable stop (**Figure 4**).
2. Loosen the axle locknuts (**Figure 5**), do not remove.
3. Lift the bicycle chain, right-hand side, off of the rear sprocket. It is not necessary to remove the master link.

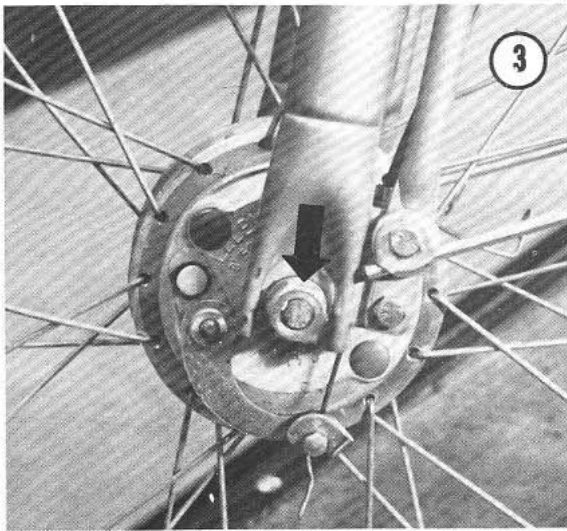

4. Remove the drive chain, left-hand side, by removing the master link (**Figure 6**) as follows: pry the outer clip off with a thin bladed screwdriver; remove the outside plate; then push the inside plate, complete with pins, out through the back of the chain and remove the chain.

5. Pull the wheel rearward and remove it. Support moped by placing the rear swing arm on a wooden box or blocks of wood.

6. Install by reversing the removal steps.

CAUTION

*Be sure to insert slot in brake plate onto the stud on the rear swing arm (**Figure 7**). This is necessary for proper brake operation.*

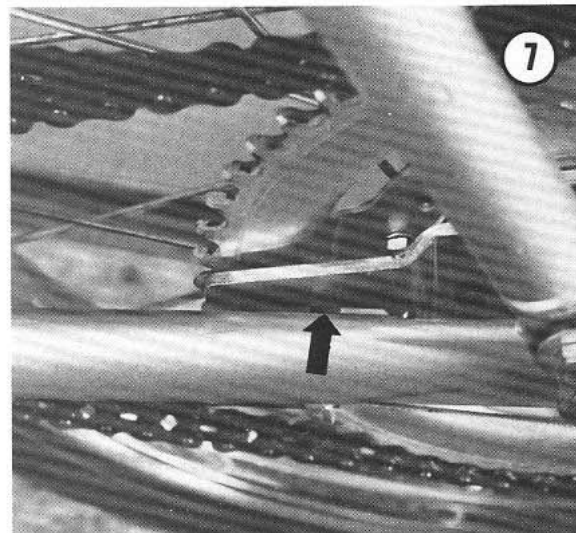
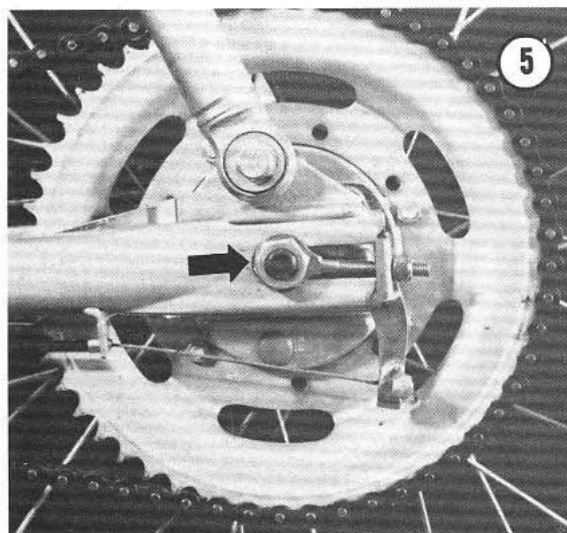
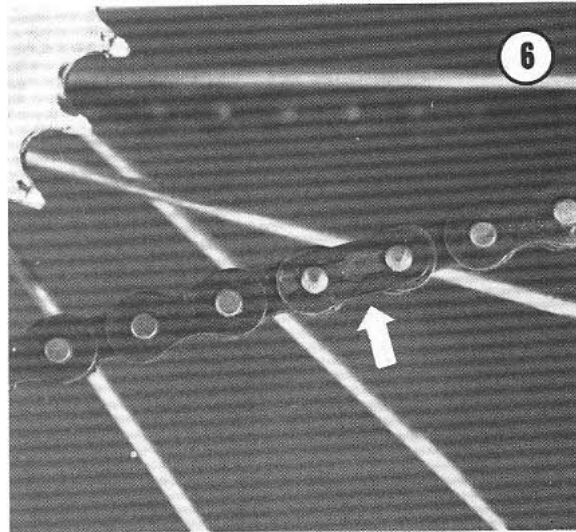
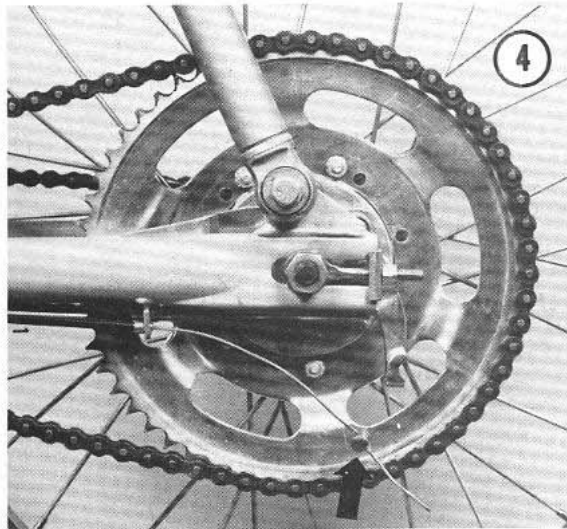

7. Make sure the master link clip is installed with the opening facing in the opposite direction of chain travel (**Figure 8**). Incorrect installation will result in the loss of the clip and possibly, chain breakage.

8. After the wheel and chain have been reinstalled it is necessary to adjust the chain tension as described under *Drive Chain Adjustment* in Chapter Six. It is also necessary to adjust the rear brakes as described under *Brake Adjustment* in Chapter Nine.

FRONT AND REAR WHEEL HUBS

The wheel hubs (**Figure 9**) consist of an axle "A", adjusting cone "B", locknut "C", loose balls, and the hub/drum.

NOTE: On some late 1977 and later models the rear wheel is fitted with sealed bearings (Figure 10) that are pressed into the rear hub. For removal, take the wheel assembly to your dealer and let him perform this operation.

The front and rear hubs are basically the same, except for the number of balls used. The disassembly and assembly are the same.

Removal/Installation

1. Remove the wheel as described under *Front or Rear Wheel Removal/Installation* in this chapter.
2. Remove the brake plate assembly and speedometer unit (**Figure 11**) on front wheel.
3. Place the wheel horizontally in a vise with the brake drum facing up. Securely grip the lockwasher and cone in the vise jaws.
4. Hold the adjusting cone, with a cone wrench, and loosen the locknut and remove both locknut and adjusting cone.
5. Remove from vise and slide the axle out of the hub assembly.
6. Leave the remaining cone and locknut on the axle unless one of these parts is damaged. If it is necessary to remove either of these, measure the distance from the end of the axle to the top of cone (**Figure 12**) so that the cone can be reinstalled in the same position.

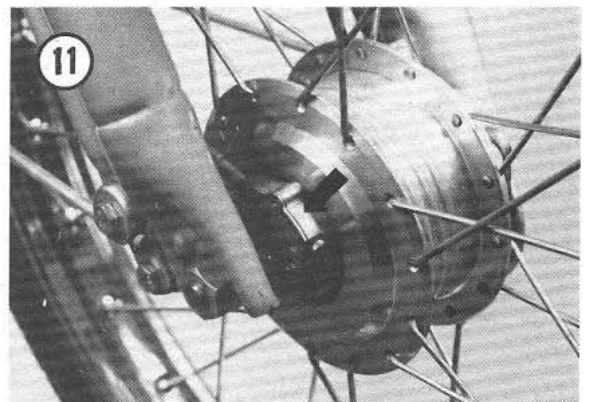
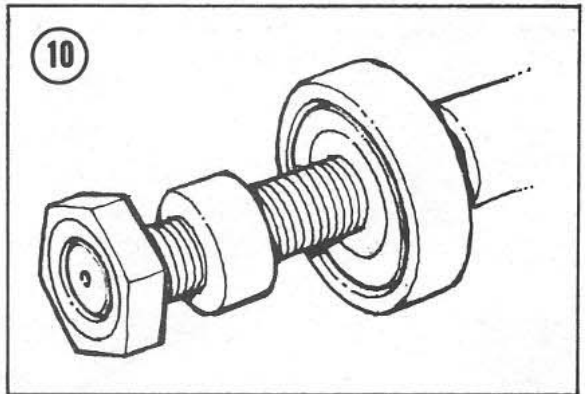
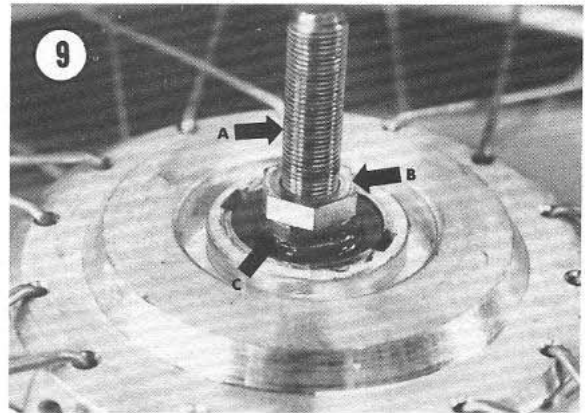
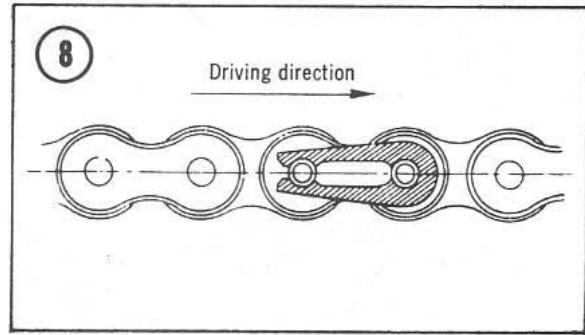

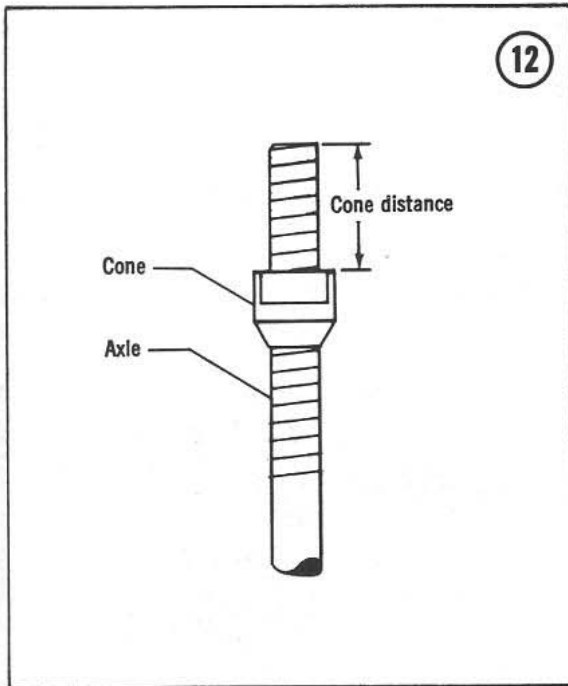

7. To remove balls, pry out retaining washer with a wide bladed screwdriver. Remove balls and count them, 11 on each side on the front and 13 on each side on the rear, so that the same number are installed. Turn the hub over and repeat the steps on the other side.

Inspection

1. Clean all parts thoroughly in solvent.
2. Check cone and hub cups for pitting and excessive wear. If the cups are damaged they should be removed. To remove the cups, insert a hardwood stick in from the opposite side and with a hammer, carefully tap the cup out from the inside. Tap all the way around the cup so that neither the cup nor the hub will be damaged. Install the cup by placing it into the hub and tapping it gently and squarely in with a block of hard wood and a hammer. Make sure it seats completely.
3. Check the balls for pitting or wear. Replace the complete set of balls if any are defective.
4. Check the retaining washers for distortion or cracks, replace if necessary.
5. Check the axle for damaged threads or if it is bent, replace if necessary.
6. Check adjusting cone and locknut threads for damage, replace if necessary.

Installation

1. Pack the ball cups with wheel bearing grease and replace the correct number of balls. The front has 11 on each side and the rear has 13 on each side. There will be a little space left over as the balls are not real snug against each other. Replace the ball retaining washer by tapping into place with a plastic mallet.
2. Insert the axle and install the remaining cone and locknut.
3. Tighten cone until all axle end play has been removed but the axle will still rotate freely.
4. Tighten the locknut and recheck.
5. Install the wheel as described under *Front or Rear Wheel Removal/Installation* in this chapter.

SPOKES

The spokes support the weight of the moped and the rider. They also transmit accelerating and braking forces.

Spokes should be checked periodically for looseness or bending. Check spokes for proper tension. The "tuning fork" method for checking tension is simple and works well. Tap each spoke with a spoke wrench or screwdriver shank. A taut spoke will emit a clear, ringing tone; a loose spoke will sound flat. All spokes in a correctly tightened wheel will emit tones of similar pitch, but not necessarily the same tone.

Bent, stripped, or otherwise damaged spokes should be replaced as soon as they are detected. Unscrew the nipple from the spoke at the rim, then push the nipple far enough into the rim to free the end of the spoke, taking care not to push the spoke all the way in. Remove the defective spoke from the hub, then use it to match a new one of the same length. Install by reversing the removal steps. Check the new spoke periodically; as it will stretch and must be retightened several times until it takes its final set.

Spokes tend to loosen as the moped is used. Retighten each spoke one turn, beginning with those on one side of the hub, then those on the other side. Tighten the spokes on a new moped after the first 50 miles of operation, then at 50 mile intervals until they no longer loosen.

TIRES AND TUBES

Tire Removal

Refer to **Figure 13** for this procedure. Always leave the locknuts on the axle to protect the threads during tire removal/installation.

1. Unscrew valve core from the valve stem with a special tool (**Figure 14**) and deflate tire.
2. Press entire bead on both sides of the tire away from rim and into the center of the rim.

3. Lubricate the beads with soapy water.
4. Insert a tire iron under the top bead next to the valve. Force the bead on the opposite side of the tire into the center of the rim and pry the bead over the rim with the tire iron.
5. Insert a second tire iron next to the first to hold the bead over the rim. Then work around the tire with the first tire iron, prying the bead over the rim. Be careful not to pinch the inner tube with the tire irons.

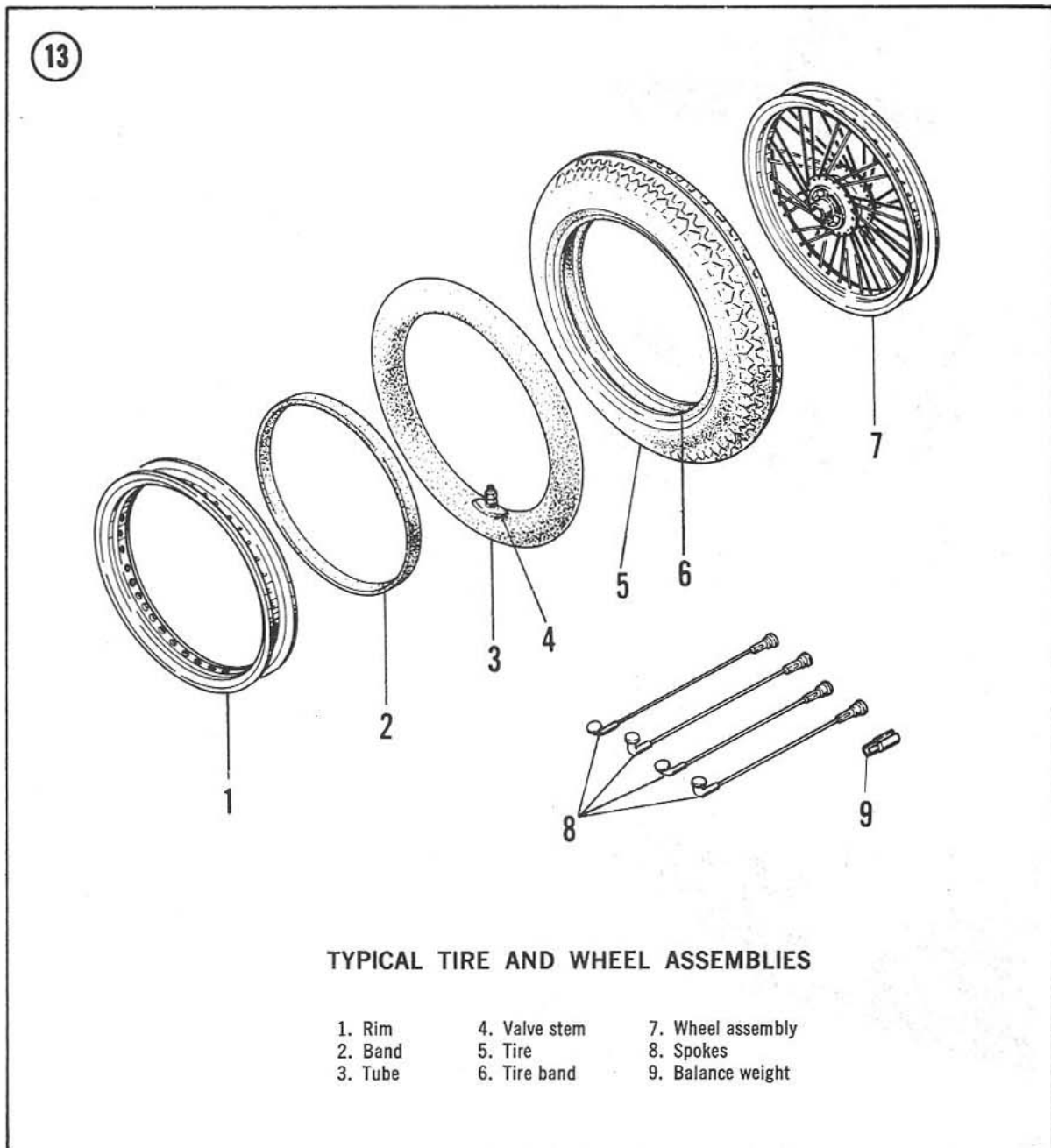

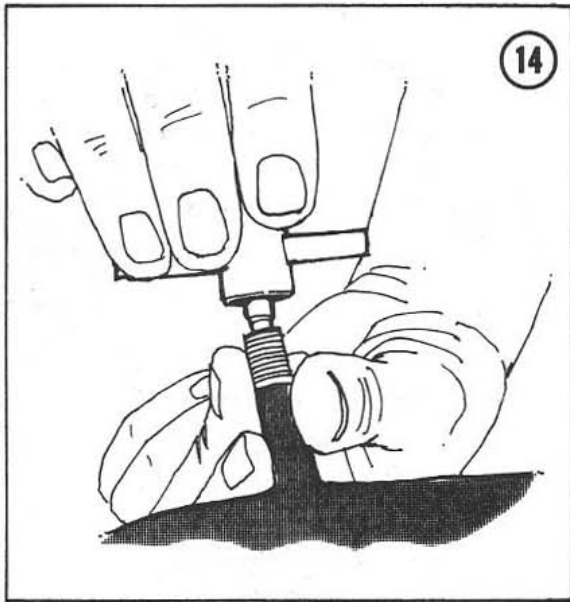

6. Remove the valve from the hole in the rim and remove the tube from the tire.

NOTE: Step 7 is required only if it is necessary to completely remove the tire from the rim such as for tire replacement.

7. Insert a tire iron between the back bead and the side of the rim that the top bead was pried over. Force the bead on the opposite side from the tire iron into the center of the rim. Pry the back bead off the rim working around as with the first.

Tube Inspection

1. Install the valve core into the valve stem and inflate the tube slightly. Do not overinflate.
2. Immerse the tube in water, a section at a time. See **Figure 15**. Look carefully for bubbles indicating a hole. Mark each hole and continue checking until you are certain that all holes are discovered and marked. Also make sure that the valve core is not leaking; tighten it if necessary.

NOTE: If you do not have enough water to immerse sections of the tube, try running your hand over the tube slowly and very close to the surface. If your hand is damp, it works even better. If you suspect a hole anywhere, apply some saliva to the area to verify it (Figure 16).

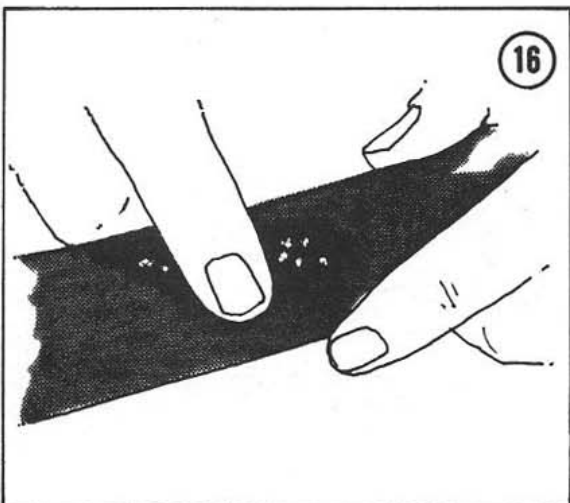
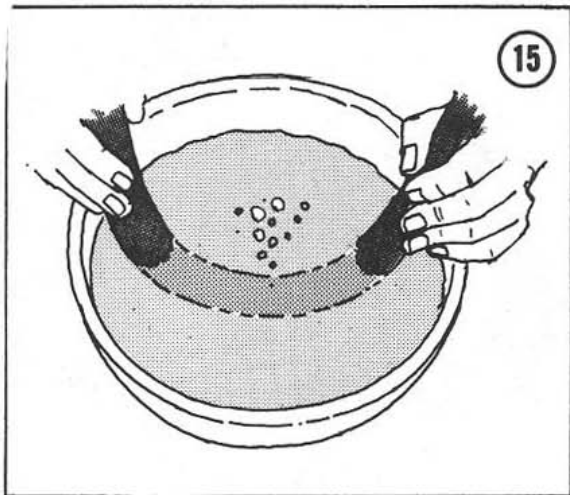

3. Apply a patch using either the hot or cold patch techniques described under *Tire Repairs* in this chapter.
4. Dust the patch area with talcum powder to prevent it from sticking to the fire.
5. Carefully check inside the tire casing for glass particles, nails, or other objects which may have damaged the tube. If the inside of the tire is split, apply a patch to the area to prevent it from pinching and damaging the tube again.
6. Check the inside of the rim. Make sure the rim band is in place and no spoke ends protrude through which could puncture the tube.
7. Deflate tube prior to installation in the tire.

Tire Installation

1. Inflate the tube just enough to round it out. Too much air will make installation difficult (Figure 17).
2. Place the tube inside the tire (Figure 18).
3. Place back side of the tire into center of rim and insert the valve stem through the rim hole (Figure 19).
4. Starting opposite the valve stem, press the lower bead into the rim center working around the tire in both directions. Use a tire iron for the last few inches of bead (Figure 20).
5. Press the upper bead into the rim opposite the valve (Figure 21) and work around the tire in both directions with your hands (Figure 22). Use a tire iron for the last few inches of bead.
6. Wiggle the valve to be sure that the tube is not under the bead. Set the valve squarely in its hole before screwing in the valve nut to hold it against the rim.
7. Check the bead on both sides of the tire for even fit around the rim. Inflate the tire slowly to seat the beads in the rim. It may be necessary to bounce the tire to complete the seating. Inflate to correct pressure; front tire 25-26 lbs., rear tire 31-32 lbs.

TIRE REPAIRS

Tire/tube damage will eventually strike even the most careful rider. Repair is fairly simple on all tires.

Tire Repair Kits

Tire repair kits can be purchased from moped or motorcycle dealers and some auto supply stores. When buying, specify that the kit you want is for moped tires.

There are 2 types of tire repair kits for mopeds:

- a. Hot patch
- b. Cold patch

Hot patches are stronger because they actually vulcanize to the tube, becoming part of it. The repair kit for hot patching is bulkier and heavier than cold patch kits, therefore hot patch kits are more suited for home repairs.

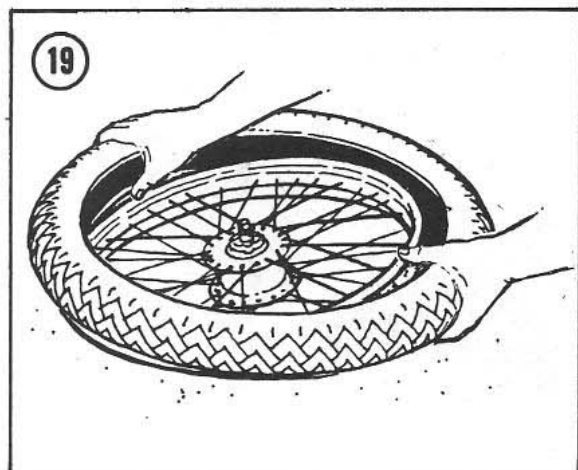
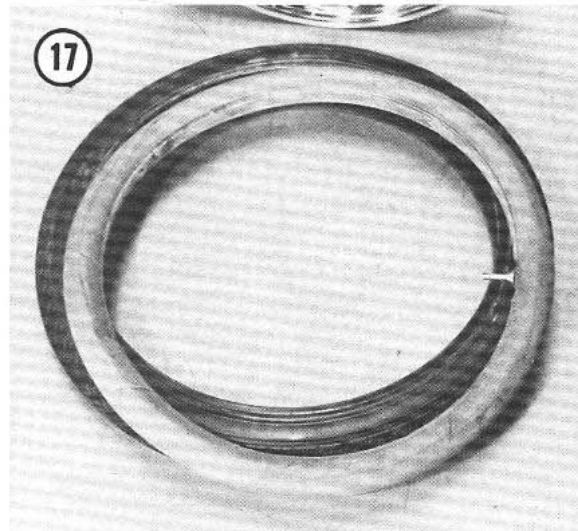

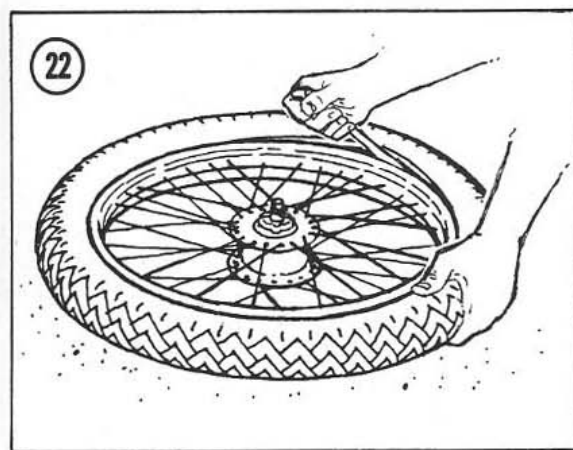
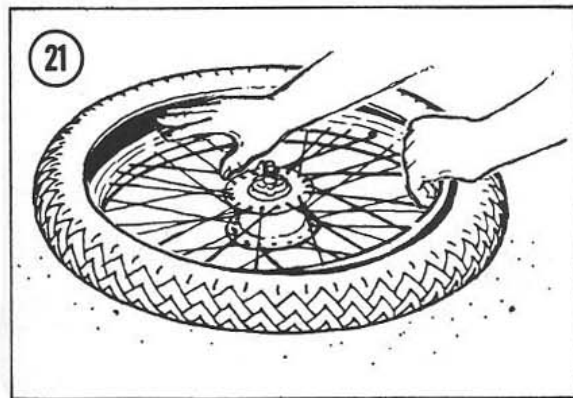
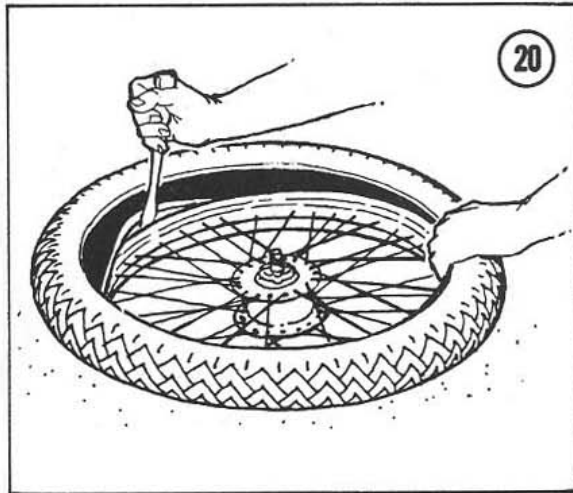

Cold patches are not vulcanized to the tube; they are simply glued to it. Though not as strong as hot patches, cold patches are still very durable. Cold patch kits are less bulky than hot and more easily applied under adverse conditions. Cold patch kits are best for emergency repairs on the road.

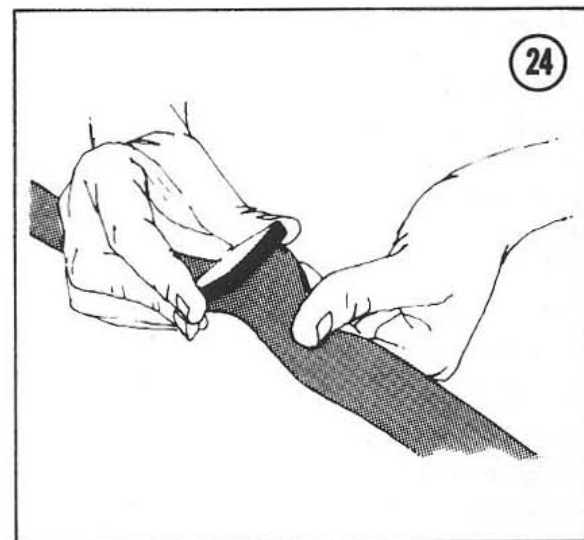
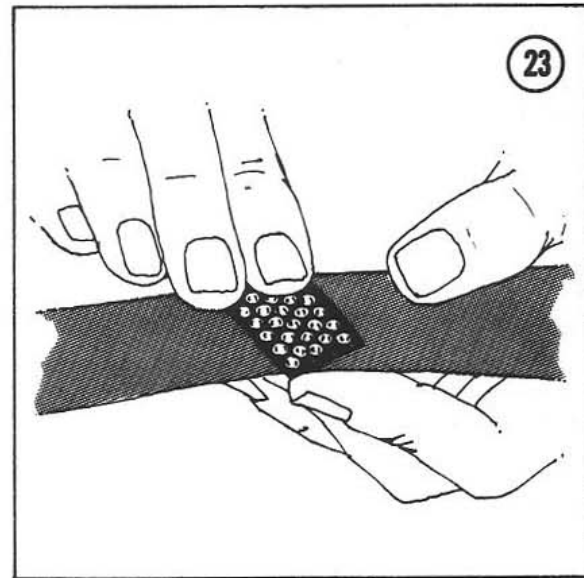

Hot Patch Repair

1. Remove the tube from tire as described under *Tire Removal* in this chapter.
2. Roughen area around hole slightly larger than the patch (**Figure 23**). Use a pocket knife or similar tool to scrape the tube; be careful that you don't cause further damage.
3. Remove the backing from patch.

CAUTION

Do not touch newly exposed rubber with your fingers. This will prevent a good seal.

4. Center the patch over hole (**Figure 24**).

5. Install clamp around tube so that it holds the fuel container over the patch (**Figure 25**).
6. Pry up a corner of the fuel and light it. Let all of the fuel burn away.

CAUTION

The clamp gets hot, so don't touch it until it cools.

7. Remove the clamp and peel the tube off the fuel container (**Figure 26**).

Cold Patch Repair

1. Remove the tube from tire as described under *Tire Removal* in this chapter.
2. Roughen area around hole slightly larger than the patch. Use a cap from tire repair kit or pocket knife. Do not scrape too vigorously or you may cause additional damage.
3. Apply a small quantity of special cement to the puncture and spread it evenly with your finger (**Figure 27**).
4. Allow the cement to dry until tacky — usually 30 seconds or so is sufficient.
5. Remove the backing from the patch.

CAUTION

Do not touch the newly exposed rubber with your fingers or the patch will not stick firmly.

6. Center patch over hole. Hold patch firmly in place for about 30 seconds to allow the cement to set (**Figure 28**).
7. Dust the patched area with talcum powder to prevent sticking.

HANDLEBAR

Removal/Installation

1. Loosen, but do not remove, the Allen head screw securing the hand grips to the handlebar (**Figure 29**).
2. Slide off both hand grip assemblies, it is not necessary to remove the cables from the grips. Lay the grip assemblies on the front fender, be careful not to kink the cables.
3. Remove the switches by removing the screw on the underside of the clamp (**Figure 30**).

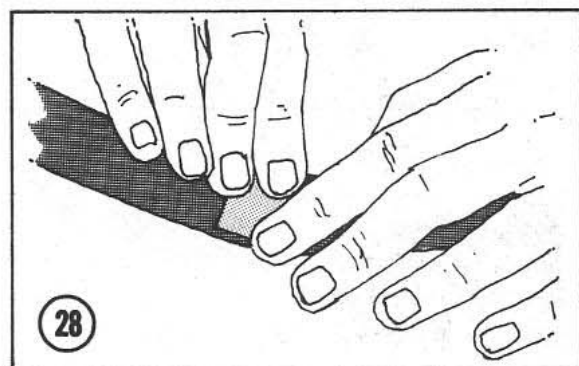
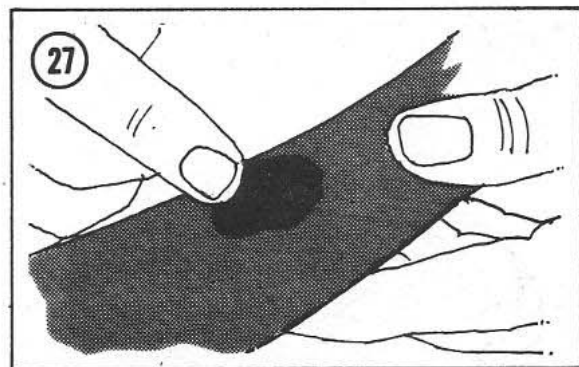
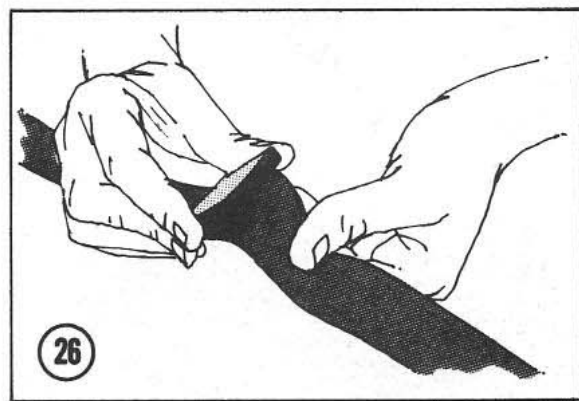
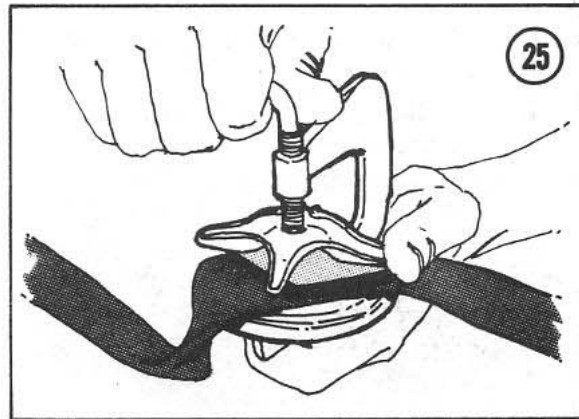

4. Remove the 4 bolts, lockwashers, and nuts securing the handlebar to the fork assembly (Figure 31).

5. Remove the speedometer and bracket and lay it over the front fender, be careful not to kink the cable.

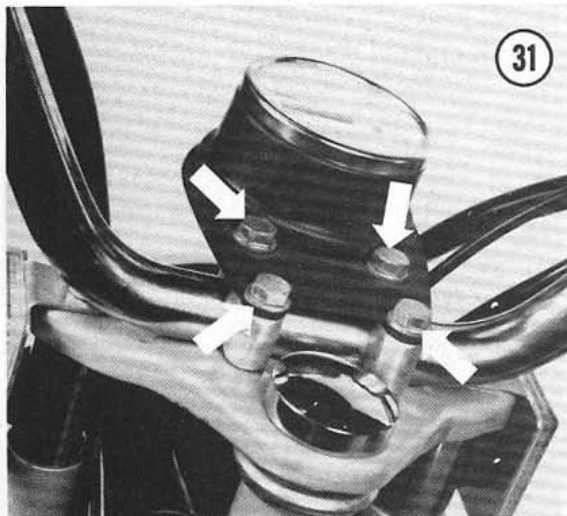
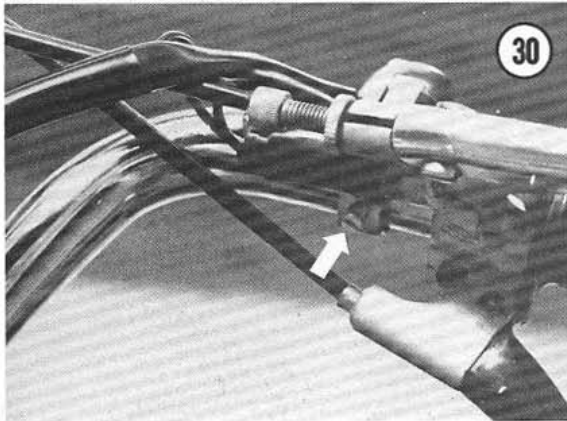
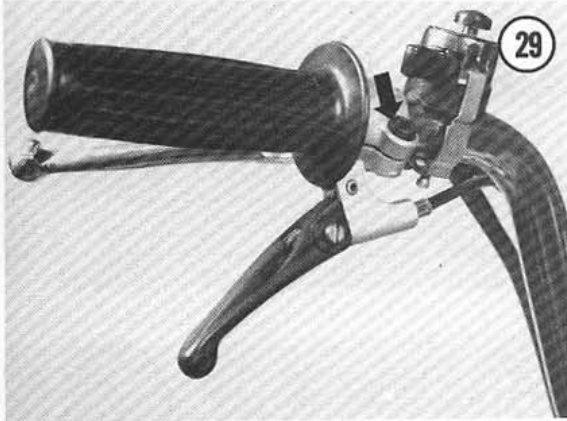

6. Remove the handlebar.

7. Install by reversing the removal steps. Adjust the handlebar and hand grip assemblies to your comfort. Do not overtighten the Allen head screws.

HEADSET

The headset consists of parts inside the head tube which secure the fork to the frame and permit it to turn. Refer to Figure 32 for all related parts.

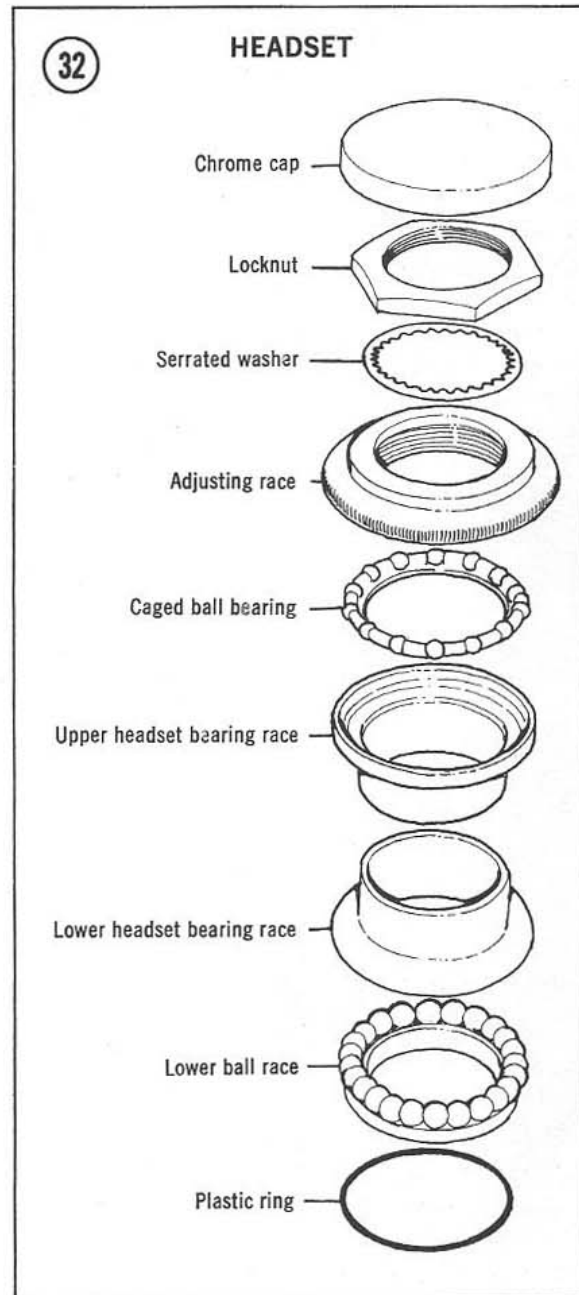

Adjustment

If the fork turns stiffly or feels overly loose, it probably requires adjustment.

1. Pry off the chrome cap (**Figure 33**), be careful because it is plastic and may crack or chip.
2. Loosen the locknut (**Figure 34**).
3. Loosen the adjusting race, tighten it hand tight (**Figure 35**) then back off (counterclockwise) $\frac{1}{4}$ turn. Tighten the locknut.
4. Turn the wheel back and forth. If it feels stiff, loosen the locknut and loosen the adjusting race another $\frac{1}{4}$ turn. Tighten the locknut. If it still feels stiff, it requires overhauling as described under *Headset Disassembly/Assembly/Inspection* in this chapter.
5. Check the fork for excessive play. Lift the front wheel clear of the ground, then set it down; look for vertical play. Now hold the handlebar with one hand and a fork tube with the other. Try to wiggle the assembly from side to side, looking for horizontal play. If there is any vertical or horizontal play, loosen the locknut and tighten the adjusting race $\frac{1}{4}$ turn. Tighten the locknut and recheck play. If it is still present, it requires overhauling as described under *Headset Disassembly/Assembly/Inspection* in this chapter.

Disassembly

1. Remove the handlebar as described under *Handlebar Removal/Installation* in this chapter.
2. Place an old blanket or pad on the floor and lay the moped on the *right-hand side*.
3. Remove front wheel as described under *Front Wheel Removal/Installation* in this chapter.
4. Remove the headlight and headlight bracket bolts (**Figure 36**) and remove the bracket.

NOTE: Prior to removal of headlight brackets, measure the distance between the bottom of the headlight bracket and the lower fork brace (Figure 37). Install in the same position.

5. Loosen nuts on lower fork brace (**Figure 38**).

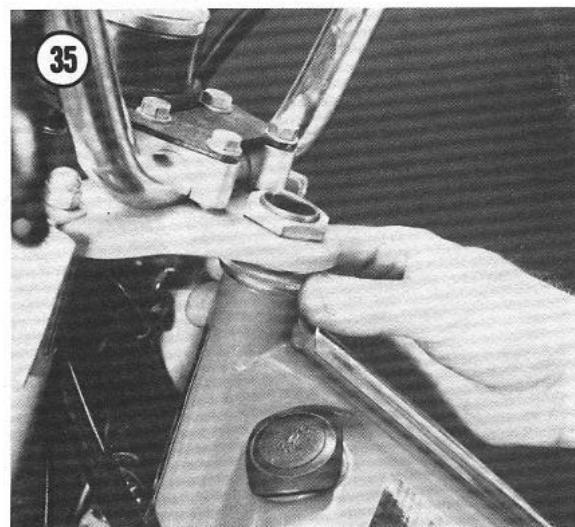
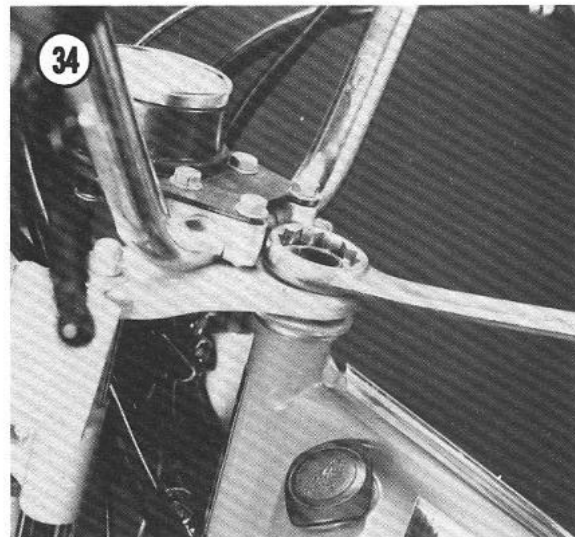
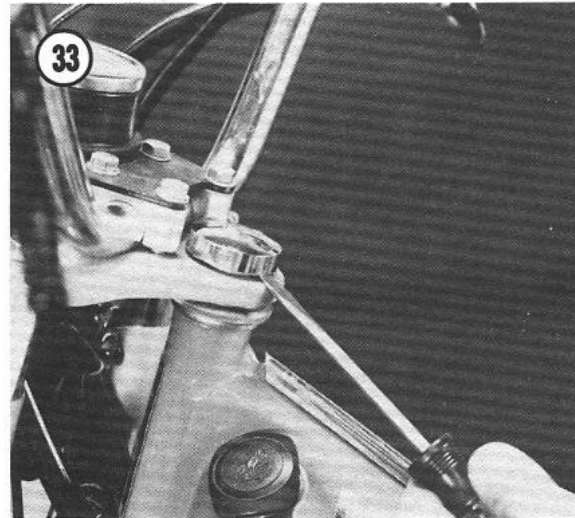

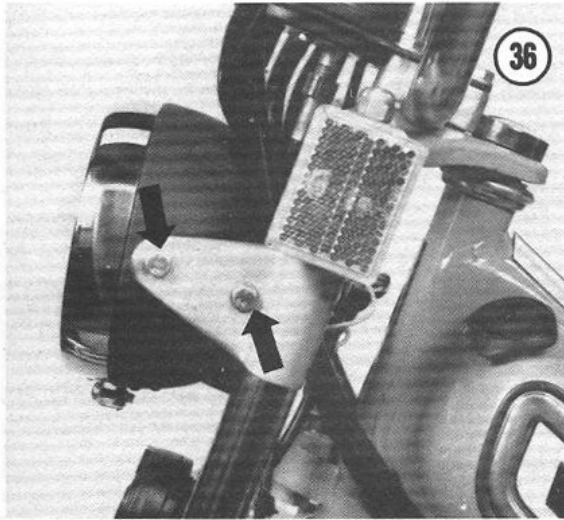

6. Remove the upper nut, lockwasher, and reflector (**Figure 39**) on each fork tube.

7. Slide forks and fender out from lower fork bracket; don't lose the serrated washer at top of upper fork tube (**Figure 40**).

8. Pry off chrome cap (**Figure 33**). Be careful because it is plastic and may chip or crack.

9. Remove locknut and serrated washer (**Figure 34**) and remove upper fork brace.

10. Unscrew and remove adjusting race and caged ball bearing.

11. Slowly pull lower fork brace and steering stem out from head tube. The lower bearing has loose balls (25 of them) and some may fall out during removal. Be prepared to catch them.

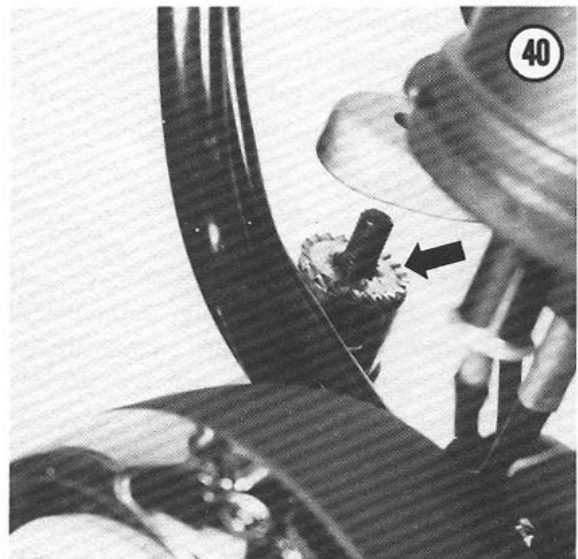
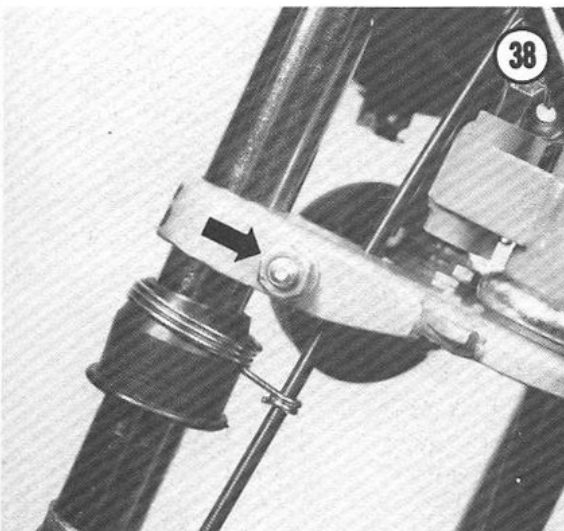
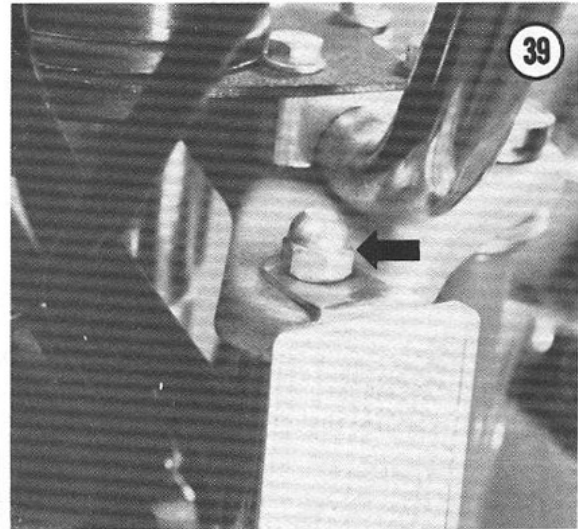
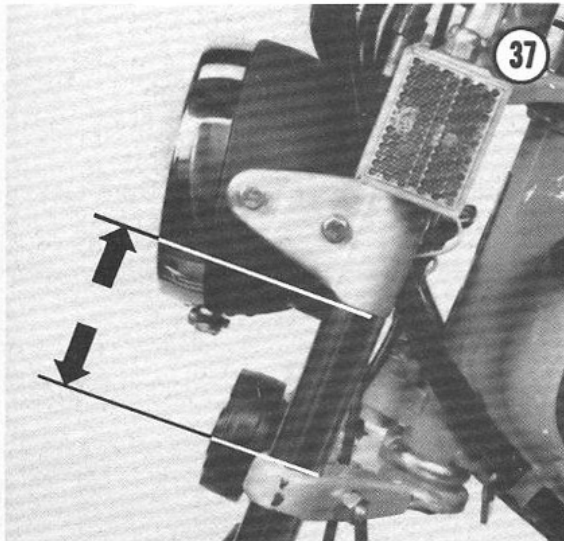

Assembly

1. Coat lower bearing race with cold multipurpose grease and install the 25 balls. If grease is too warm and/or balls will not stay in place, it may be necessary to turn the moped upside down.

NOTE: Prior to turning the moped upside down it is necessary to drain the fuel tank. Turn the fuel shutoff valve to the OFF position and remove the fuel line from the carburetor. Place the loose end of the fuel line into a metal can that can be sealed. Do not put it into your gasoline can as it already has oil added to it. Remove the fuel tank fill cap, turn the fuel shutoff valve to RESERVE and drain fuel. After draining the tank, turn the fuel shutoff valve to OFF, replace fill cap, and seal the metal container.

WARNING

Do not smoke or have any open flame in the area while performing this procedure. Also have a fire extinguisher suitable for gasoline fires within reach.

2. Install lower fork brace and steering stem from the bottom being careful not to dislodge any balls. Replace the upper caged bearing.
3. Continue the assembly by reversing the removal steps. Be sure to install the serrated washer on top of the upper fork tubes (**Figure 40**), and to reposition the headlight in the same position as removed in Step 4.
4. After assembly steps are completed, it is necessary to readjust the head set as described under *Headset Adjustment* in this chapter.

Inspection

1. Clean all parts in cleaning solvent.
2. Check bearings for pitting, scratches, or discoloration which indicates wear. Replace them if necessary; take old bearings to dealer to ensure exact replacement.
3. Check upper and lower headset bearing races and top adjusting race for pitting, scratches, and discoloration which indicates wear. Replace if necessary.

Bearing Race Replacement

The headset bearing races are pressed into place. They are easily bent; do not remove them unless they are worn and require replacement. Take old races to dealer to ensure exact replacement.

To remove a headset race, insert a hardwood stick into the head tube and carefully tap the race out from the inside (**Figure 41**). Tap all the way around the race so that neither the race nor the head tube are bent. To install the race, fit it into the end of the tube. Tap it slowly and squarely with a block of wood as shown in **Figure 42**.

NOTE: The upper and lower races are different. See Figure 35 to be sure that you install them at the proper end of the head tube.

FRONT FORK

Figure 43 shows components from one side of the front fork.

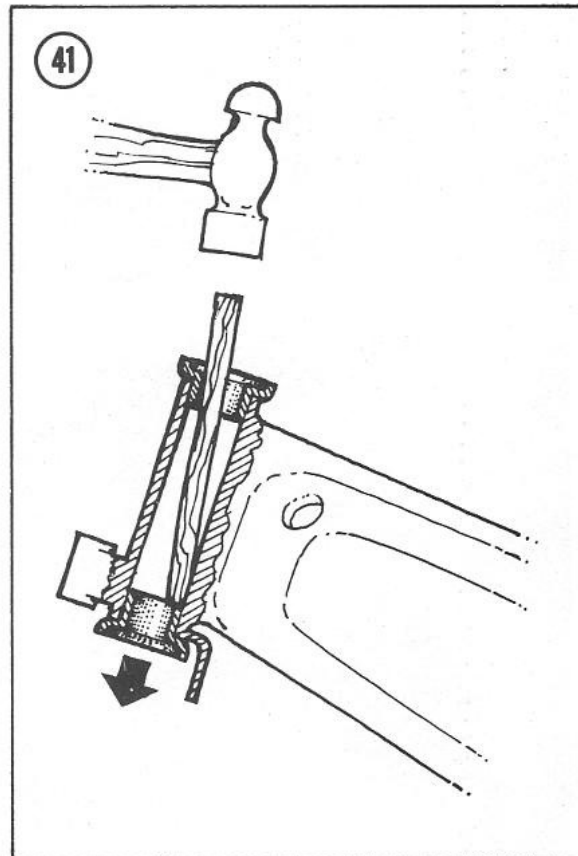

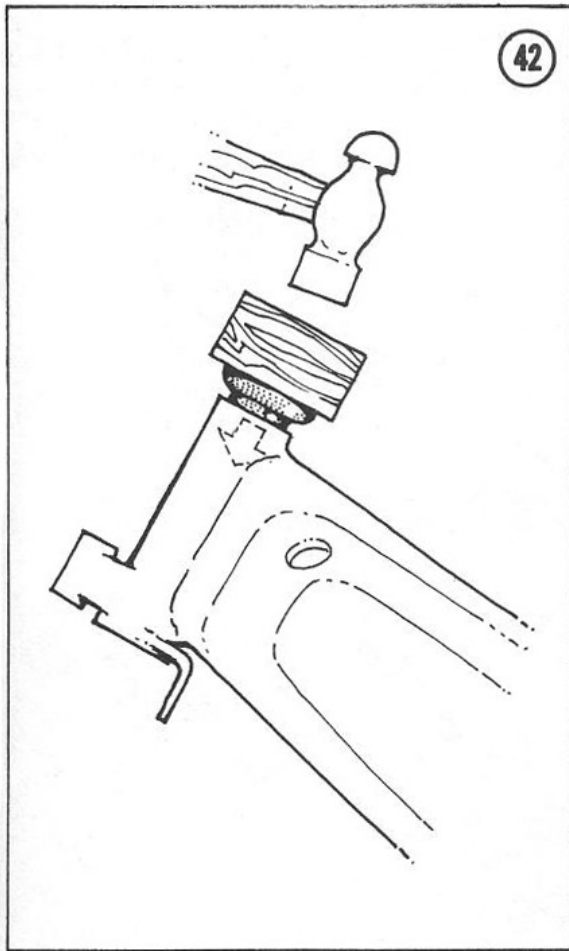

Removal/Installation

1. Remove front wheel as described under *Front Wheel Removal/Installation* in this chapter.
2. Lay the moped on the right-hand side or block up the engine to support the moped after the front wheel has been removed.

NOTE: *It is suggested that you disassemble one side at a time.*

3. Remove the fender bracket bolts (Figure 44).

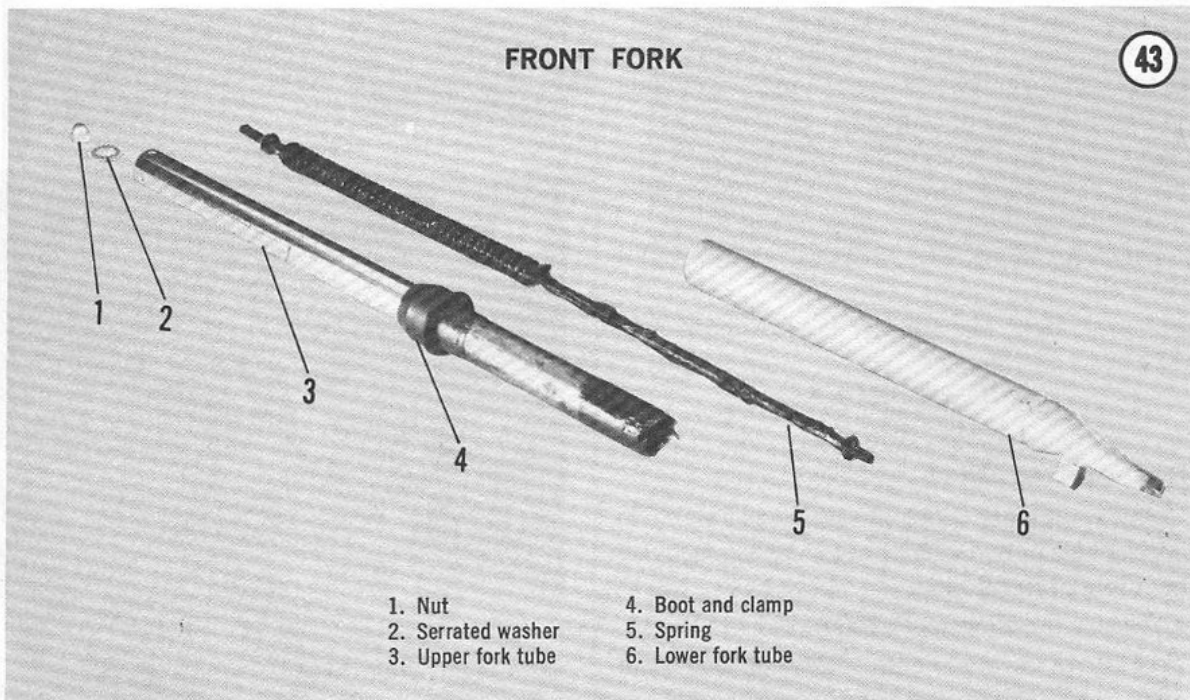
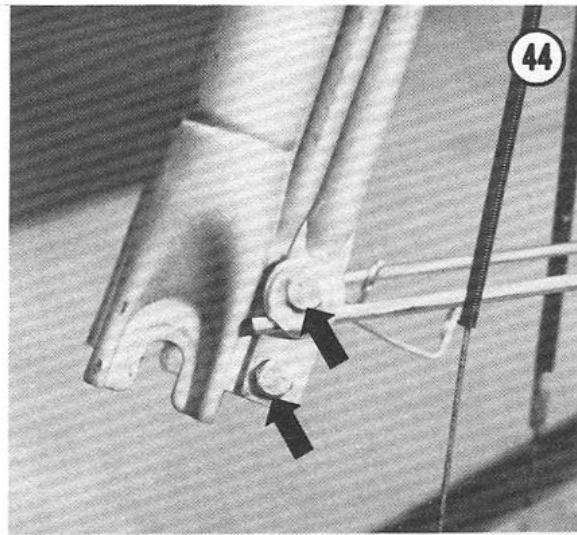

FRONT FORK

- | | |
|--------------------|--------------------|
| 1. Nut | 4. Boot and clamp |
| 2. Serrated washer | 5. Spring |
| 3. Upper fork tube | 6. Lower fork tube |

4. Squeeze the boot clamp and slide it and the boot up on the upper tube (**Figure 45**).
5. Remove upper nut, lockwasher, and reflector while holding the lower tube (**Figure 46**).
6. Slide off lower tube complete with internal spring (**Figure 47**).
7. Loosen nut on lower fork brace (**Figure 48**).
8. Loosen nut on headlight bracket (**Figure 49**).
9. Slide upper tube out of both brackets, catch the serrated washer at the top of the tube (**Figure 50**).
10. Unscrew the spring from lower tube and inspect it as described under *Front Fork Inspection* in this chapter.
11. Install by reversing the removal steps. Be sure to install the serrated washer on top of the upper tube (**Figure 50**).

Inspection

Unscrew the coil spring from the lower tube. If the grease looks as though it is not contaminated, do not remove it. Add a good grade of multipurpose grease to it if necessary.

If the grease packed around the spring has been contaminated with dirt or water, the spring should be thoroughly cleaned with cleaning solvent. Wipe out the inside of the lower fork tube with rags on a long rod. Avoid pouring cleaning solvent into the tube as it is difficult to thoroughly dry out. Wipe off outside of the upper tube.

Repack the spring, coat the inside of the lower tube and the outside of the upper tube with a good grade of multipurpose grease.

Screw the spring back into the lower tube and reinstall.

REAR SHOCK ABSORBERS

Removal/Installation

Always replace shock absorbers as a pair, do not replace only one as this will affect the road handling of the moped.

1. Place moped on centerstand.
2. Remove the lower bolt, lockwasher, and nut on each side (**Figure 51**).

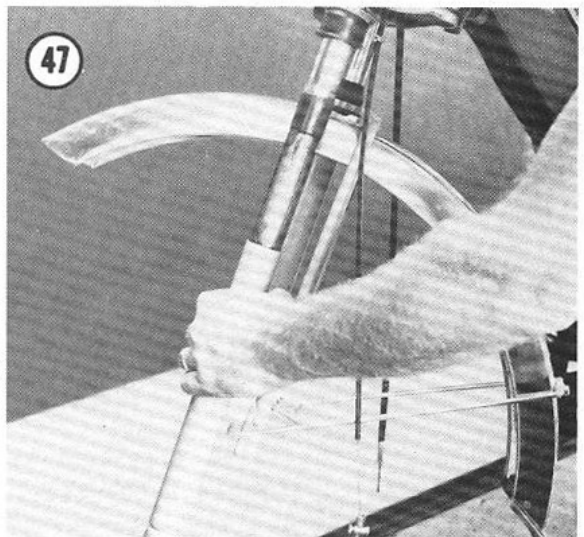
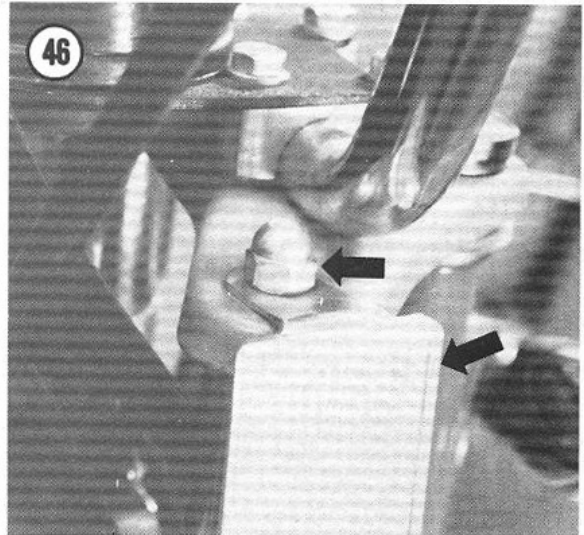
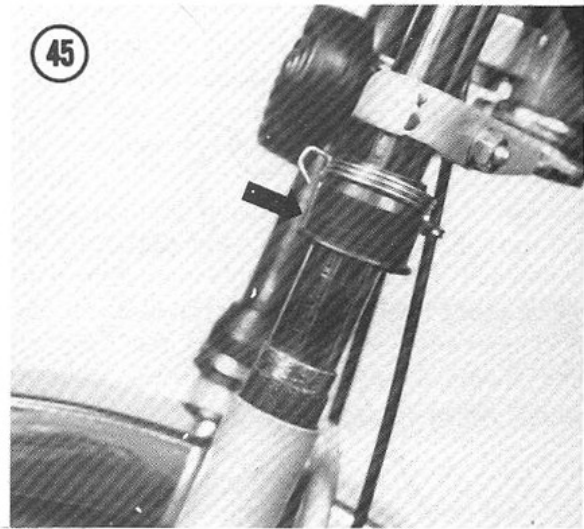

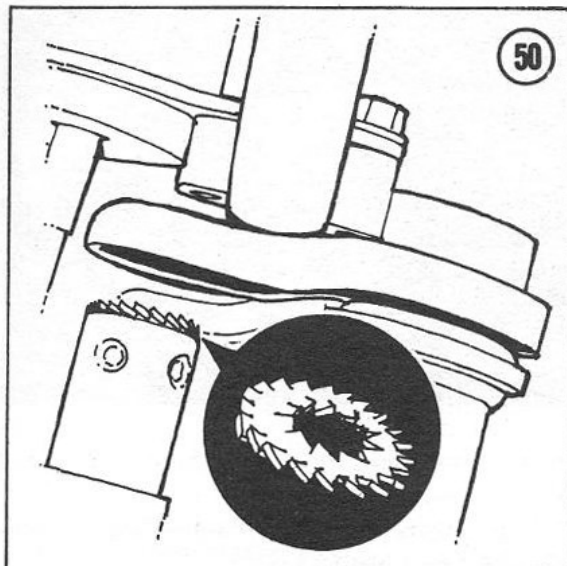
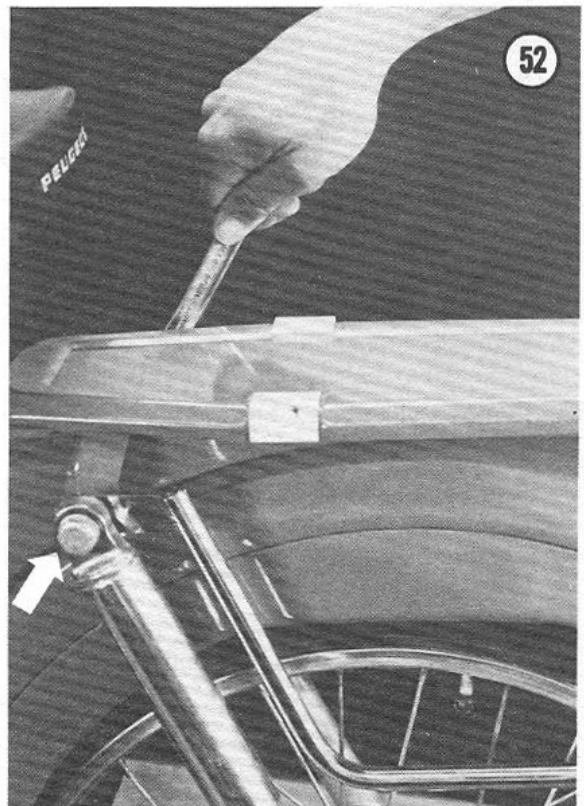
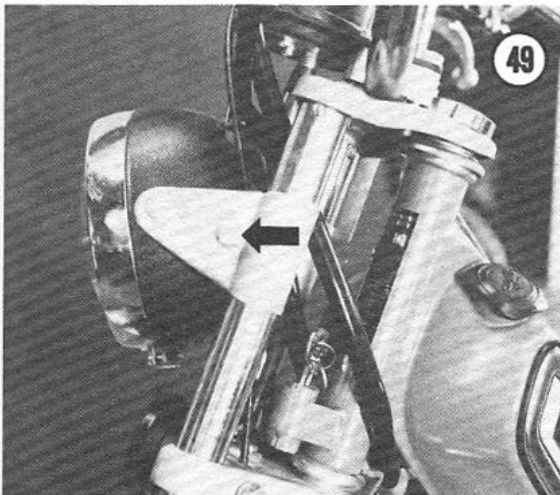
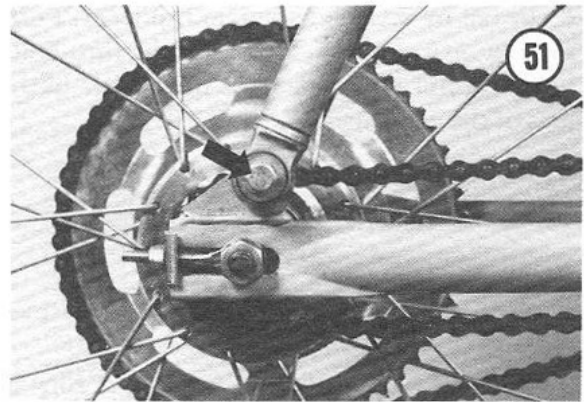
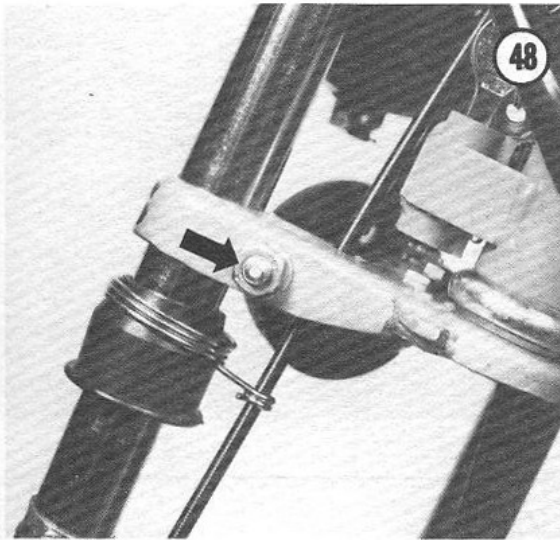

3. Remove the upper nut and lockwasher (Figure 52).

NOTE: The upper bolt extends all the way through from one side to the other securing the upper end of both shocks.

4. Knock out the thru-bolt with a $\frac{3}{8}$ in. rod, or wood dowel, and leave in place while removing the old shocks. Perform this step slowly in order to keep all the spacers in place; this will aid during installation.

5. Remove the old shocks.

6. Install by reversing the removal steps. Push the rod or wood dowel out with the thru-bolt, being careful not to damage the rubber bushings of the new shocks.

REAR SWING ARM

Removal/Installation

1. Remove screws securing both engine fairings and remove the fairings.
2. Remove engine as described under *Engine Removal/Installation* in Chapter Five.
3. Remove crank arms as described under *Crank Arm Removal/Installation* (Chapter Six).
4. Remove drive pulley as described under *Drive Pulley Removal/Installation* (Chapter Six).
5. Remove rear wheel as described under *Rear Wheel Removal/Installation* in this chapter.
6. Remove the lower end of both shock absorbers as described under *Shock Absorber Removal/Installation* in this chapter.
7. Remove centerstand as described under *Centerstand Removal/Installation* in this chapter.
8. Remove thru-bolt, bushing, and locknut (**Figure 53**) and remove swing arm from frame.
9. Install by reversing removal steps.

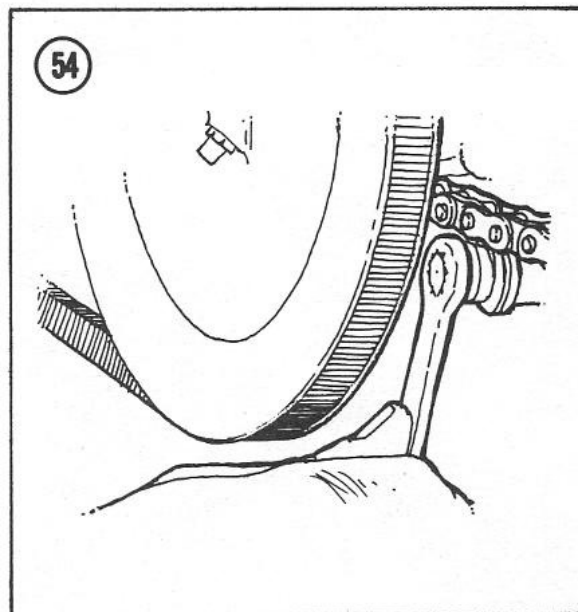
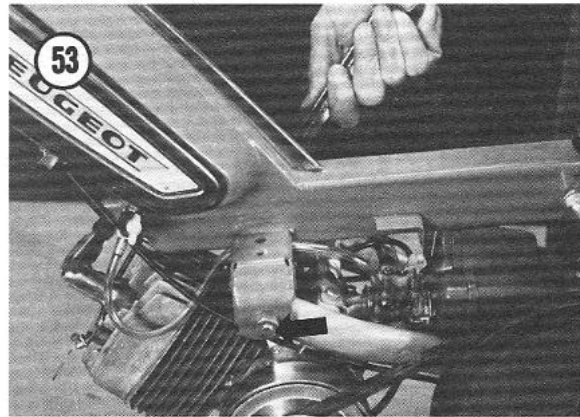

Centerstand

Removal/Installation

1. Place old blanket or pad on floor and lay moped down on *right-hand side*.
2. Place the centerstand in the raised position and remove return spring, using a pair of pliers to pull the hook end off at attachment loop.
3. Remove thru-bolt with a wrench (**Figure 54**). It may be necessary to hold the opposite end of bolt with Vise-Grip pliers.
4. Slide thru-bolt out the right-hand side.
5. Install by reversing the removal steps. Apply a small amount of multipurpose grease to the points where the centerstand rotates.

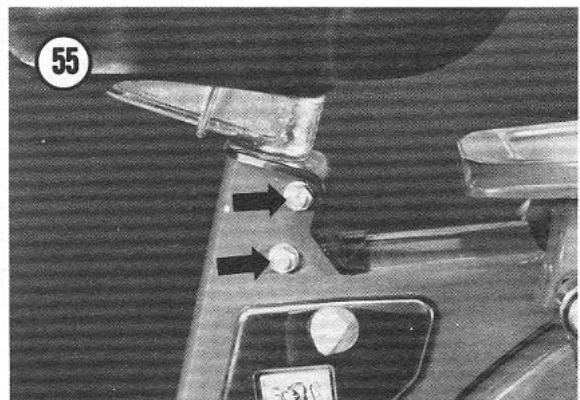

SEAT

Removal/Installation

Loosen, but do not remove, the 2 bolts and nuts (**Figure 55**) securing seat and stem into the

seat support unit. Pull the seat and stem up and out to remove.

Install by reversing the removal steps. Adjust the seat to the proper height.

INDEX

A
Air filter60-61

B
Bicycle chain27, 53-54
Bolts8, 12-14
Brakelight 67
Brakes
 Adjustment27-28
 Cable71-72
 Drum 73
 Lining72-73
 Troubleshooting 33
Breaker points22-23, 64-65

C
Carburetor
 Cleaning 58
 Overhaul 58
 Removal and installation57-58
 Tune-up adjustment 23
Chains26-27, 53-55
Clutch
 Assembly48-50
 Disassembly46-48
 Inspection 48
 Installation50-51
 Removal45-46
 Troubleshooting 33
Components, description 1-4
Condenser 64
Cooling system 34
Crank arm52-53
Crankcase splitting 44
Crankshaft seal 43
Cylinder38-40
Cylinder head36-38

D
Decarbonizing24-25
Decompressor valve 42
Description 1-4
Drive chain26, 53-55
Drive pulley28, 55-56

E
Electrical system
 Accessories and instruments65-70
 Magneto63-65
 Troubleshooting 33
Emergency troubleshooting 31

Engine
 Cooling 34
 Crankcase splitting 44
 Crankshaft seal 43
 Cylinder38-40
 Cylinder head36-38
 Decompressor valve 42
 Intake valve43-44
 Lubrication 34
 Operating principles 34
 Piston and wrist pin40-41
 Piston cleaning and inspection 41
 Piston ring41-42
 Removal and installation34-36
 Troubleshooting31-33
Exhaust system61-62

F
Fork, front86-88
Frame
 Fork, front86-88
 Handlebar82-83
 Headset83-86
 Seat 90
 Wheels and hubs74-87
Fuel system
 Air filter60-61
 Carburetor57-58
 Fuel filter 60
 Fuel shutoff valve 60

G
General information 1-6

H
Handlebar82-83
Headlight 66
Headset83-86
Horn33, 68
Hubs76-77

I
Ignition gauge 12
Ignition timing18-22
Impact driver 12
Intake valve43-44

L
Lighting system33, 65-68
Lubricants25-26
Lubrication26, 34

M	
Magneto	
Breaker points	64-65
Condenser	64
Description	16-18
Ignition timing	18-22
Removal and installation	63-64
Maintenance (also see Tune-up)	
Bicycle chain adjustment	27-28
Brake adjustment	27-28
Cleaning solvents	26
Drive belt adjustment	27
Drive chain adjustment	26
Drive pulley	28
Front forks	28
Fasteners	28-29
Lubricants	25-26
Periodic lubrication	26
Spokes	28
Storage	29
Wheels and tires	28
Muffler	61-62
N	
Nuts	8, 12-14
O	
Oil and grease	25-26
P	
Parts replacement	6
Pedals	52
Piston, pin, and ring	40-42
Pliers	10
S	
Safety	6
Screwdrivers	9-10
Screws	8, 12-14
Seat	90
Service hints	4-6
Shock absorbers, rear	88-90
Spark plug	15-16
Speedometer illumination light	67
Spokes	28, 77
Starting	31-32
Storage	29
Suspension	
Fork, front	86-88
Shock absorbers, rear	88-90
Swing arm, rear	90

Troubleshooting	33
Swing arm, rear	90
Switches	67-68

T

Taillight	67
Threads, nuts, bolts, and screws	7-8
Timing	18-22
Tire lever	12
Tire repair	80-82
Tires and tubes	78-80
Tools	
Broken screws or bolts	14
Fasteners	7-9
Frozen nuts and screws, removing	12-13
Ignition gauge	12
Impact driver	12
Pliers	10
Screwdrivers	9-10
Spoke wrench	12
Stripped threads	13
Tire lever	12
Wrenches	11-12
Transmission	
Chains	53-55
Crank arm	52-53
Drive pulley	55-56
Variable drive pulley	51-52
Troubleshooting	
Brakes	33
Clutch	33
Electrical	33
Emergency troubleshooting	31
Engine	31-33
Operating requirements	30-31
Suspension	33
Tune-up	
Air filter	23
Breaker points	22-23
Carburetor	23
Decarbonizing	24-25
Magneto	16-18
Magneto ignition timing	18-22
Spark plug	15-16

V

Variable drive pulley	52
-----------------------	----

W

Washers	9
Wheel, front	74
Wheel, rear	74-76
Wrenches	11-12

PEUGEOT MOPED

OWNER SERVICE / REPAIR
1976-1978

103LVS-U2

103LVS-U3

This manual is part of the first professionally-written do-it-yourself repair series for moped enthusiasts. Fully detailed procedures on tune-up, troubleshooting, lubrication, and major maintenance enable owners to perform virtually any repair required.

The text is by an expert technical writer, and has been illustrated by scores of photos and drawings prepared especially for this book. Emphasis throughout is on simple step-by-step procedures and the remedies needed for reliable operation.

Specific areas of coverage include: the engine, fuel system, cooling system, electrical system, power train, suspension, and steering.

As in all Clymer service books, the goal has been to help owners understand their equipment, lower repair costs, and generally improve operating satisfaction. Clymer moped, snowmobile, motorcycle, auto, and marine maintenance books are sold worldwide. Look for them at your local dealer, parts supplier, or bookstore.

CLYMER PUBLICATIONS • LOS ANGELES