

KREIDLER

MO-PED MP 9 USA

Operating Instructions and Owners Manual



Operating Instructions and Owners Manual

Table of contents

| | Page | | Page |
|------------------------------------|------|---------------------------------|------|
| Nomenclature location | 3 | Drive chain and chain alignment | 23 |
| Preparing for initial start | 8 | Steering | 25 |
| During operation | 10 | Wheels and brakes | 26 |
| Stopping and parking | 11 | Electrical system | 29 |
| Gasoline and oil | 11 | Vehicle cleaning | 32 |
| Servicing and maintenance | 13 | Operation in wintertime | 33 |
| Maintenance schedule | 13 | Storage | 33 |
| Engine | 16 | Troubleshooting | 34 |
| Ignition system | 17 | Technical data | 36 |
| Fuel and exhaust systems | 19 | Wiring diagram | 39 |

Nomenclature location

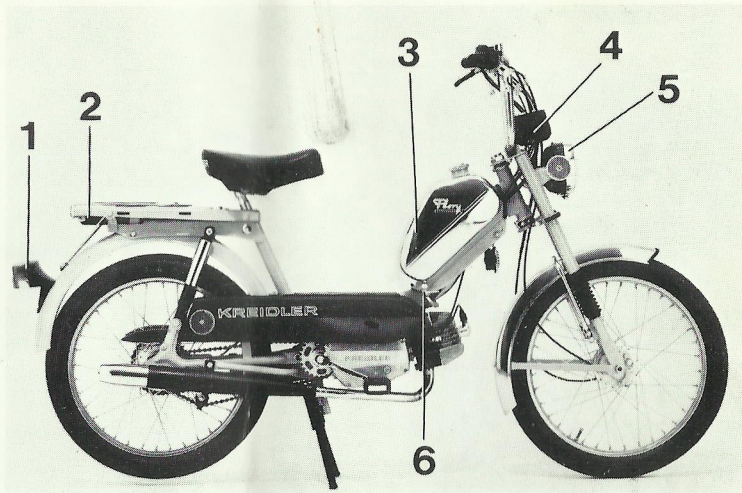

- 1 taillight
- 2 tool kit
- 3 fuel tank

- 4 speedometer
- 5 headlight
- 6 fuel valve



1 steering lock

2 horn

4

3 inflation pump

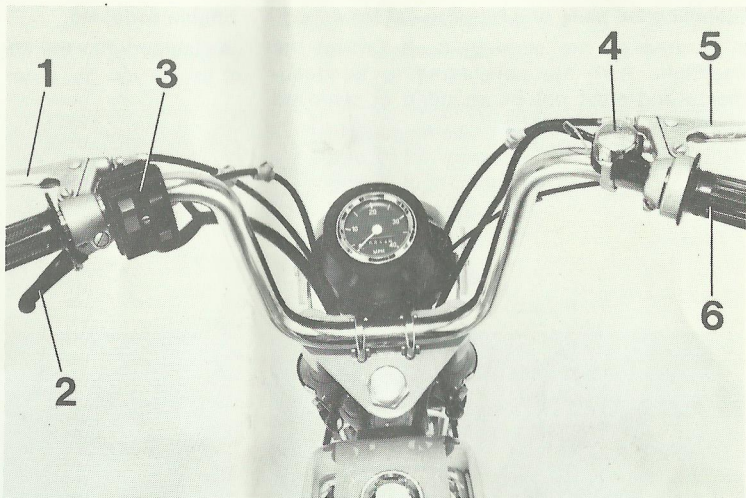

- 1 rear wheel brake lever
- 2 Decompression and start clutch lever (choke)
- 3 headlight switch
Hi-Lo-Off-On Horn Button

- 4 Off-On switch
- 5 front wheel brake lever
- 6 throttle twist grip

Identification plate and frame serial No.

is located on the steering head behind the headlight. Both are considered to be documents and must not be changed or removed under any circumstances.

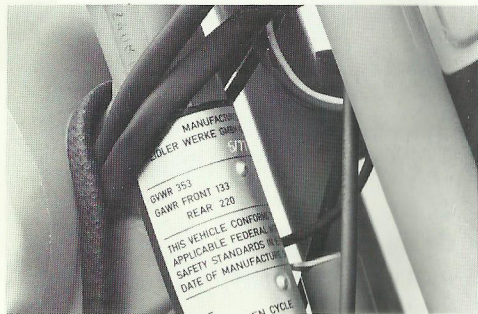

Engine serial No.

is stamped into the engine on the right side.

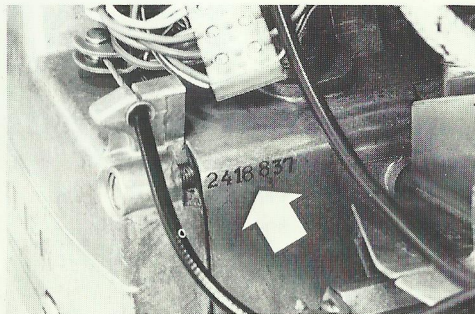

Tool kit

underneath luggage carrier. For removing press rear wall in and force lug out of slot in the luggage carrier.

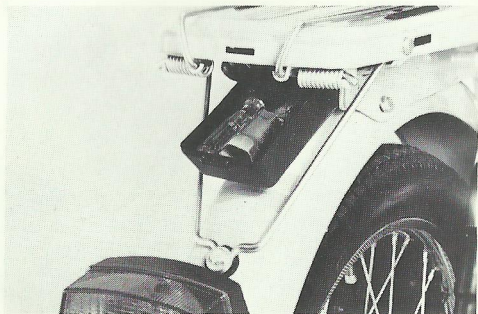

Switch on left handlebar

- A = headlight switch
pos. 1: lights off
pos. 2: lights on
- B = high-beam switch
pos. 3: low-beam
pos. 4: high-beam
- C = headlight flasher
- D = horn operation
- E = rear brake lever
- F = start clutch lever (choke)

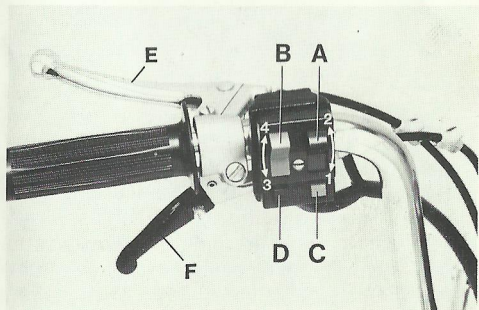

Important information before first operation of moped

“OFF-RUN“ control switch

located on right handlebar

pos. 1: off

pos. 2: run

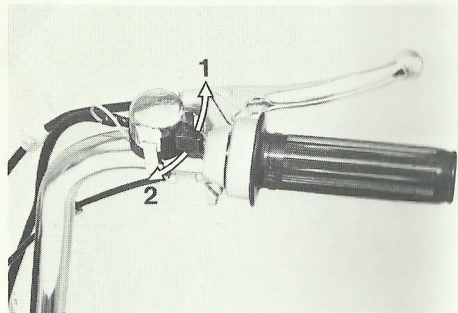

Front forklock

Insert key into steering lock, turn approx. 45° to the left simultaneously pulling. Release and withdraw key.

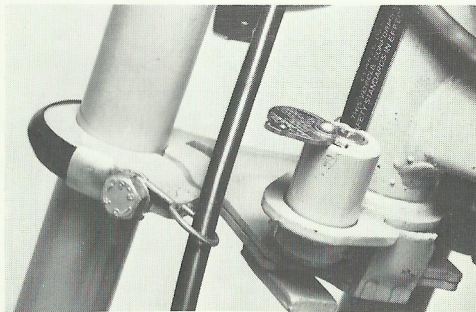

Fuel in tank?

Pure gasoline severely damages engine and notifies warranty. The required gasoline/oil mixture must be in the ratio 50:1 – watch the gas station attendant closely and see that the proper amount of oil is added (see also page 11 on gasoline and oil).

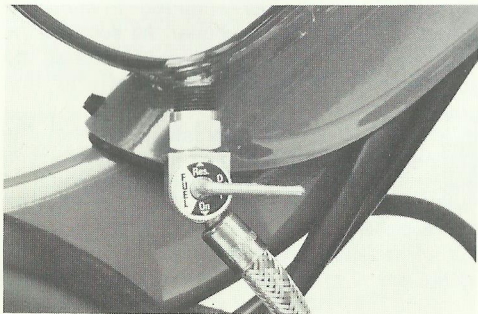

Tire pressure

should not be checked with the thumb. Use a tire pressure gage every time you stop in for fuel see "Technical data" for correct tire pressure – check pressure when tires are cold.

Brakes

are checked by pulling both brake levers and trying to move the vehicle without engine power, or by dealer inspection.

Signal

test signal horn

Starting engine

Start vehicle using pedals, pull start clutch lever on left handlebar after a few wheel revolutions and twist throttle grip a little bit toward yourself. Release lever and accelerate slowly by further twisting the throttle grip toward yourself.

Choke

Depress the pressure pin protruding over the carburetor top on left hand top side of engine cover (causes enrichment of the mixture for easier cold start) — the pin returns to its normal (travel) position when you turn the throttle.

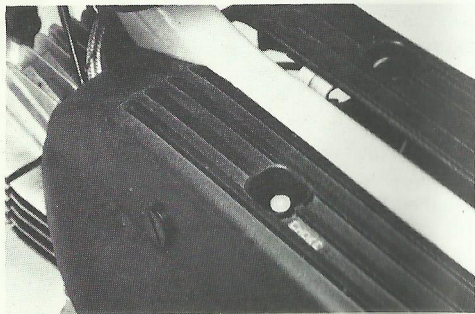

Checking lights

Turn on the lights with engine running and check headlight, taillight and stoplight.

Starting engine at night

As described above, with lights turned off so that the full igniting capacity of the magneto reaches the sparkplug for starting. Turn light on when engine is running.

During operation

When the engine has acquired a sufficient speed, it shifts to second gear. As soon as the engine speed drops below a certain speed the automatic gear system shifts down to first gear.

If a slope is excessively steep so that the engine is subjected to too much stress, you may assist the engine by using the pedals.

When you stop for traffic lights, pull both brake levers and have engine run idling. Never accelerate while your vehicle is stopped and the brake levers are pulled because this would unnecessarily strain the gearing.

Stopping and parking

Return throttle twist grip to idling position and brake the vehicle.

Stopping engine

Always operate the "Off-Run" switch on the right handlebar (see page 8). Do not operate the start clutch lever on left handlebar because as the engine will not stop because of the loss of compression but will be stalled.

Parking vehicle

Always close fuel valve. Place vehicle on kick stand and secure via steering lock by inserting key, turning same approx. 45° to the left simultaneously depressing it in counterclockwise direction and swinging the handlebar to the right until the lock cylinder rests in the catch. Release and withdraw the key.

Gasoline and oil

No advantage from premium gasoline

Use regular gasoline. Being a two stroke engine the Moped engine does not respond to high-octane gasoline. Please use regular octane gasoline fuel.

There is a difference in oil

Without any doubt the special 2 T (two stroke) oil, a special type for two stroke engines, is ideal, i. e. 2T oil contains an effective anti-corrosive agent because of the acidic combustion products in the cold engine – and 2T oil leaves very little combustion deposits – positive results: the combustion area of the engine stays clean, no pinging, no glow ignition, no spark plug troubles (gap-bridging), clean piston bearing surfaces and piston ring grooves preventing ring jamming.

Self-mixing

You can buy standard 2 T oil which must be thoroughly mixed with gasoline in a mixing can, or the practical self-mixing 2 T oil (it is also called premixed 2 T oil because it contains approx. 10 % gasoline); the prescribed quantity of this type oil is poured directly into the tank where it readily mixes with the gasoline.

Also usable

is the worldwide available four stroke engine HD motoroil as long as you do not use a multi-grade version. The correct version is the single-grade HD oil of the viscosity class SAE 40 or SAE 50.

Internal rust inhibitor

If no 2 T oil is used but HD engine oil, we recommend particularly during wintertime the addition of additives such as "Desolite for two stroke engine" as a rust inhibitor – add the individually prescribed quantity (given on can).

The mixing ratio

must be 50 (parts of gasoline) : 1 (part of oil), independently of the type of oil used.

Engine lubrication on downhill drive

Downhill with throttle closed the engine is driven by the rear wheel. In view of the fact that the two stroke engine receives lubrication only via the fuel, it is advisable to open the throttle a little bit while going downhill although it is not a MUST.

The result of opening the throttle partially causes an oil supply to engine.

Servicing and maintenance

Maintenance schedule

| Maintenance work required at speedometer reading | 300 | 1800 | 3600 | every |
|---|-----|---|------|--------------|
| Engine | | | | |
| transmissial oil change with warm engine | x | | x | 3600 miles ■ |
| Check transmission oil level, replenish if necessary | x | x | x | 3600 miles ● |
| Tighten cylinder head screws | x | after this 300 miles after each cylinder head disassembly | | |
| Check engine mounting bolts for secure seat | x | x | x | 3600 miles |
| Clean cylinder, piston head and cylinder exhaust pipe, check piston rings for free motion. | | x | x | 3600 miles ▲ |
| Clean decompression lines in cylinder | | | | |
| Ignition system | | | | |
| Check contact breaker point gap and adjust if necessary | | | | |
| Renew breakers with scord points | x | x | x | 3600 miles |
| Check spark setting | x | | x | 3600 miles |
| Sparkplug, check electrode gap and adjust if necessary (0.4 mm) | | | x | 3600 miles ▲ |
| Grease lubrication felt of contact breaker | | | x | 3600 miles |
| Fuel and exhaust systems | | | | |
| Clean carburetor, intake filter and fuel valve | x | | x | 3600 miles ■ |

| Maintenance work required at speedometer reading | 300 | 1800 | 3600 | |
|--|-----|------|------|--------------|
| Clean exhaust system | | x | x | 3600 miles ▲ |
| Drive sprocket | | | | |
| Check chain tension under load and adjust if necessary, lubricate chain, check wheel track | x | x | x | 3600 miles ● |
| Steering | | | | |
| Check steering head bearing for play and adjust if necessary | x | x | x | 3600 miles |
| Wheels and brakes | | | | |
| Check tightness of spokes and retighten if necessary | x | | x | 3600 miles |
| Lubricate speedometer drive | x | | x | 3600 miles |
| Check front and rear brake linings for thickness (minimum 2 mm) | | | x | 3600 miles |
| Electric system | | | | |
| Check entire light system (should be repeated prior to each use) | x | x | x | 3600 miles |
| Adjust headlight | x | x | x | 3600 miles ● |
| Bowden cables | | | | |
| Lubricate Bowden cables and adjust if necessary | x | x | x | 3600 miles ● |

- Minimum once per year
- ▲ May be repeated more frequently in the event of rapid decrease of performance or maximum speed
- Depending on the operating conditions for the vehicle this work may be performed earlier.

Ask your KREIDLER dealer for performing servicing and maintenance work. Claims under guarantee are accepted only as long as the servicing and maintenance work can properly be proved by entries on the servicing and maintenance card.

On the following pages the maintenance and servicing work is listed in the same sequence as given on the maintenance schedule.

Engine

Oil draining

while engine is warm. Unscrew drain plug from center part of the case underneath the tread sprocket wheel. Wait until oil is completely drained, replace gasket, fit drain plug and tighten securely.

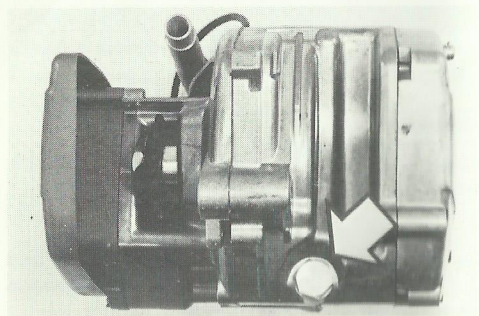

Filling oil

Unscrew oil filter plug on right side of motor case, fill in prescribed oil type in prescribed quantity (correct level: lower edge of oil filling bore), replace gasket, insert and tighten filler plug.

Checking oil level

Place vehicle on kick stand, unscrew oil filler plug — the oil level must reach the lower edge of the filler bore.



Cylinder head screws

must be retightened in the prescribed sequence (1-2-3-4).

Tighten cylinder head screws after the first 300 miles and then after 300 miles following each disassembly of the cylinder head using a torque wrench for applying the specified torque (see technical data).

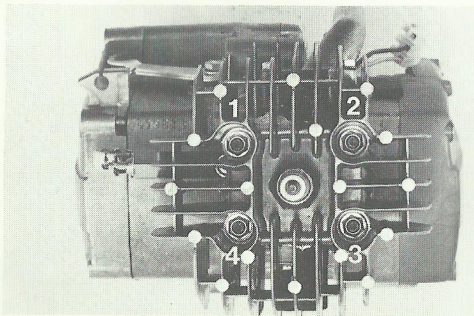

Motor mounting bolts

must be checked for tight seat in regular intervals.

Cylinder, piston head and exhaust pipe

should be cleaned by a professional mechanic only.

Ignition system

The engine is equipped with a contact-controlled flywheel magneto ("contact-controlled" means the breaker points cause the increase and decrease of the power in the ignition coil thus indirectly controlling the spark of the sparkplug).

Spark setting

is subject to changes during the course of time due to breaker point wear. Have your KREIDLER dealer perform the readjustment work because they have the necessary adjusting and checking equipment.

Sparkplug

Be sure you have a proper heat range (see technical data). Only those sparkplugs listed in the technical data ensure that the combustion temperature existing in the Mofa/Moped engine is sustained for perfect ignition – ascertain that a replacement sparkplug is one of the type listed under technical data and has a short 14 mm thread.

Sparkplug maintenance

Clean correctly: do not scrape the plug with a sharp tool – clean with a soft steel brush – cleaning the inner portions is most important; if possible use special equipment available at gas stations and your KREIDLER dealer.

Electrode wear

The external and center electrodes of the sparkplug wear during the course of time by burning, which changes the electrode gap – this causes poor starting or misfiring with the light turned on.

Remedy: Adjustment.

0.4 mm electrode gap

Take a 0.4 mm feeler gage or a piece of sheet metal exactly made to 0.4 mm thickness. Replacement of the sparkplug after about 3.600 miles is recommended because after such a long time of operation the electrodes are usually worn out.

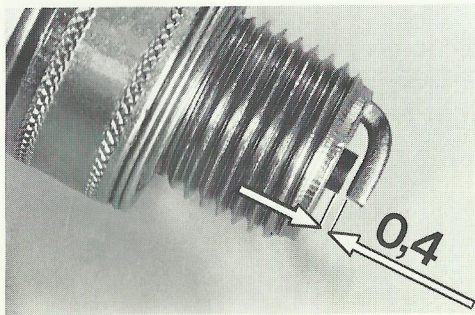

Sparkplug cover

is indispensable — in order to avoid trouble make sure the water protection (indicated by the dotted line inside the plug connector) remains intact when connector or plug are renewed.

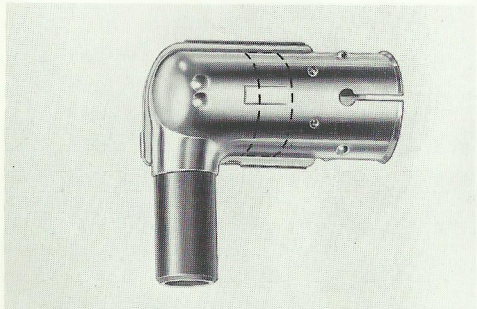

Fuel and exhaust systems

Cleaning fuel strainer

Remove screw cap and then the fuel valve from the tank. Clean strainer by blowing out. Renew gasket for refitting.

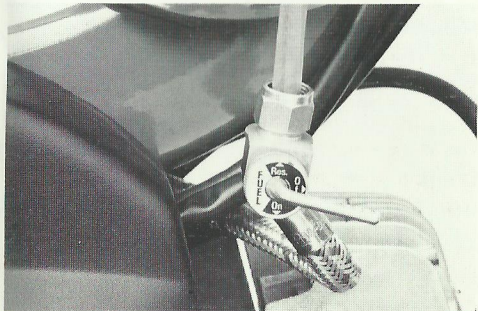

Carburetor, airfilter and muffler

Do not change anything in connection with the carburetor. Trying to make improvements would only result in destructing what KREIDLER has successfully installed, through laborious development and test work, to obtain optimal performance data from the Moped engine.

The system of the fuel from the intake at carburetor, engine and exhaust pipe to the muffler end is an extremely complex system with each component being exactly tuned to its specific function. Changes always cause negative results.

Removing carburetor

Remove airfilter (see description on page 22). Loosen carburetor binding screw (arrow 1) pull carburetor backward and away from the intake socket. Arrow 2 points to throttle slide adjusting screw.

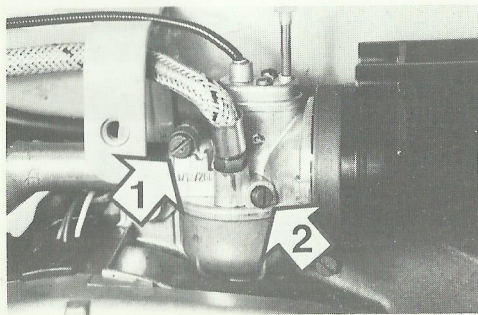

Removing throttle slide

Very seldom required, particularly since the jet needle should remain unchanged — releasing throttle slide: unscrew the two fastening screws (1) of the carburetor cover and pull throttle slide (2) out of the housing.

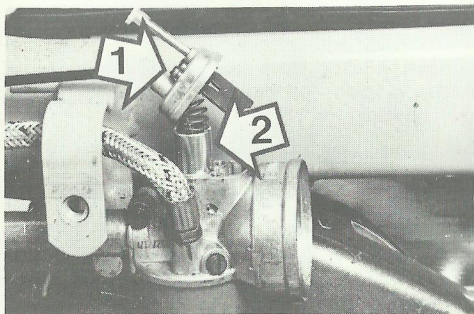

Opening float chamber

Unscrew float cap and remove float: pull pin — do not bend retainer plate; this would change the fuel level.

Cleaning jet

Blow out main jet and needle jet with your mouth or with compressed air. Never try to clean with sharp or pointed items such as needles etc.

Adjusting idle speed

The engine must have operating temperature. Screw in throttle cable, set screw as far as possible and then readjust slide set screw with a screw driver. Clockwise: faster; counterclockwise: slower.

Removing and cleaning airfilter

Loosen clip on carburetor and pull airfilter from carburetor. Pull chamber cover from intake chamber. The intake filter is cast into the intake chamber and cannot be removed. Clean all parts with gasoline, dry the filter, wet with engine oil, assemble intake silencer, connect to carburetor.

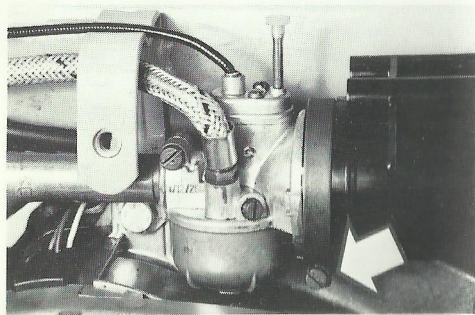

Driving without airfilter

would be improper since the engine would deliver less output in the lower and medium speed range. If no air filter is installed, dust and dirt will cause rapid engine wear.

Cleaning muffler

Two stroke engine mufflers become lined with deposits through which the bores in the muffling chambers are becoming smaller thus causing a decrease of the motor capacity. Therefore the muffler system must be regularly cleaned from such deposits.

Remove muffler from vehicle after the clips on the cylinder (arrow 1) and on the muffler (arrow 2) have been loosened.

Pull muffler from exhaust pipe and open muffler: unscrew end cap using a size 10 mm socket wrench and pull out end cap and muffler insert. Remove the deposits from all parts using a screw driver or a triangular scraper. Carefully fit asbestos cords with assembly (for proper sealing).

Burning out of the exhaust system with a welding torch or a blow torch would not be correct because the development of smoke connected with this method would pollute the environment and the chromed parts would lose their shine.

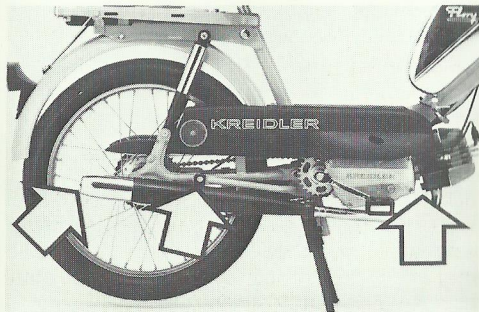

Drive chain and chain alignment

Checking chain tension

The tensioning wheel keeps the tension of the thread chain (on right side of vehicle) constant.

For checking the tension of the drive chain (on left vehicle side) place the vehicle on the kick stand and move the chain in the center of its free rings up and down using a screw driver — total displacement of 2 cm is correct.

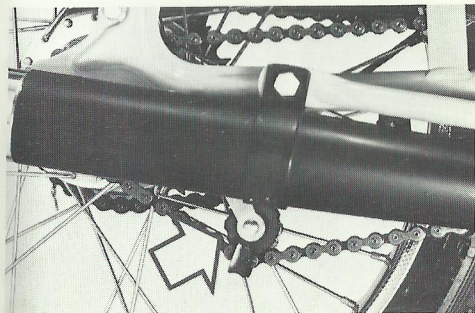

Applying chain tension

Loosen axle nuts and lock nuts of the chain tensioners on both sides. Tighten adjusting nuts equally until correct tension is obtained. Securely retighten jam nuts of the chain tensioners and the axle nuts.

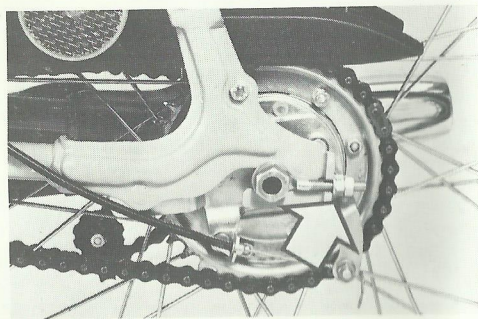

Checking wheel track

Place a straight lath against the wheels as high as possible above the floor to determine if front and rear wheel are exactly aligned (run straight in one line) — if not, correct rear wheel position accordingly (maintain 2 cm chain play).

Chain connecting link

The retaining clip is of flat steel; its closed end must **always** point in direction of chain travel.

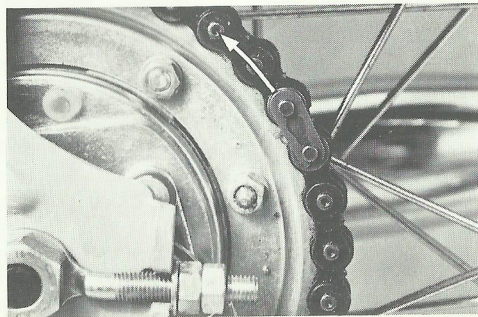

Chain maintenance

Similar to maintenance schedule – apply chain grease on both chains in regular intervals – oil is unsuitable. It is too thin and will be thrown off.

Steering

Adjusting steering head bearing

Place machine on kick stand – position yourself in front of the handlebar, grasp the telescoping fork at the lower end of the sliding tube with your hands and push and pull alternatively – if backlash is found in the steering head bearing, readjustment is absolutely necessary because the exact front wheel guide depends on it and thus the longitudinal and cornering stability of the vehicle, i. e. driving safety.

Loosen nut (arrow 1) and screw down the knurled threaded cone (arrow 2) by hand or using a pipe wrench.

It is better to adjust for more (not less) backlash in the bearing, because the play is some-

what reduced as soon as the jam nut is tightened.

Correct adjustment is indicated when the bearing is practically free of backlash and still permits easy movement – steering must not jam in any position of the total steering swing – the fork must be easily moving to the right and left end position.

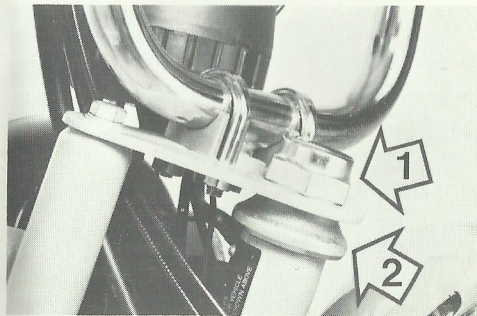

Wheels and brakes

Checking spoke tightness

should be done by your KREIDLER dealer — he has a special equipment which prevents lateral or height eccentricity which might occur when the spokes are retightened.

Lubricating speedometer drive

via lub nipple (arrow 1). Remove speedometer shaft by unscrewing the threaded cap (arrow 2) — never oil or grease the speedometer shaft itself. The lubricant would destruct the speedometer.

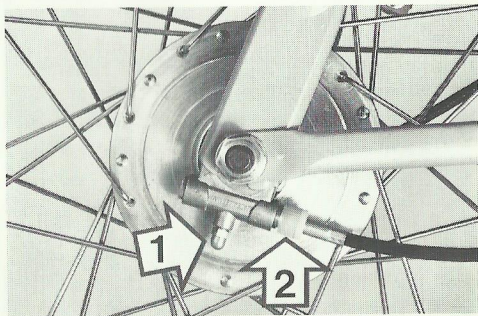

Removing front wheel

Unhook brake cable: screw in brake lever adjusting screw on handle bar as fast as possible. Loosen binder screw (arrow 1) on brake lever (on brake hub on right vehicle side) pull out brake cable and remove speedometer cable.

Unscrew axle nuts (arrows 2 and 3), pull off fender braces in lateral direction, then pull out front wheel in downward direction.

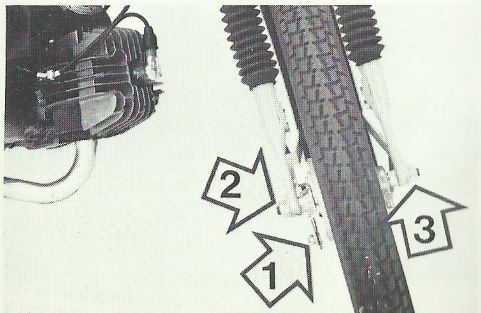

Removing rear wheel

Neither drive chain nor tread chain must be opened. Neither must the rear wheel brake cable be removed from the brake hub. Unscrew axle nut, loosen chain tensioner nuts, and remove chain tensioners from rear wheel.

Push rear wheel forward and let it slide out of the frame. Pull brake cover from the brake hub and remove drive chain from sprocket wheel and tread chain from free wheeling gear.

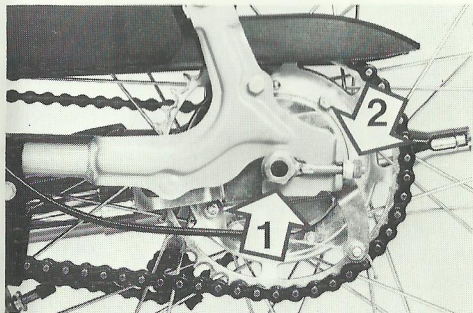

Checking brake lining

is easily done through the inspection holes in the brake covers. The inspection holes (two each on front and rear wheel) are closed by plastic plugs.

Inspect brake lining for thickness and wear. Replace plastic plugs.

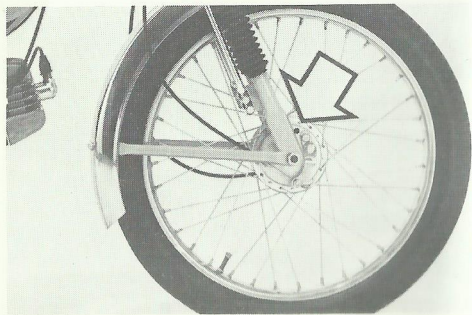

Adjusting hand (front and rear wheel) brakes

Dead travel of the brake lever on the handlebar becomes longer during the course of time, which is due to the abrasion (wear) of the brake lining — readjustment: loosen jam nut, screw set screw outward until the desired dead travel is obtained.

Adjust according to your own size of hand — adjust so that full braking action will not cause your hand to form a fist; your fingers should still be stretched out to some extent thus remaining active — if adjusted as just described, you can sensitively apply the brake, as the braking power required, or apply the full braking force if required.

Under no circumstances should the adjustment be made so that the brake linings slide along the drum — this will overheat the brake drum, and the linings will wear prematurely.

Maintenance

Pull brake cover (also called brake shoe carrier or brake shield) from the drum — remove dust with a dry brush or blow out in the workshop using compressed air — permit no gasoline or oil on the linings — oil or grease stained linings are unserviceable — do not roughen the linings for improved breaking effect, this would be entirely wrong.

Tire pressure

Check while tires are cold — do not check with your fingers or hands use a hand air gage or one of the scaled pressure gages available at any service station and check every time you stop in for gas.

For tire size and type please refer to the technical data at the end of this brochure.

Electrical system

lights should be checked before riding at night. Headlight adjustment should be frequently checked so that approaching traffic is not blinded. Set up the vehicle as shown on drawing and turn light switch to "dimmed light" (engine must be running). At a distance of 5 m the light-dark separation line must be

5 cm lower than the headlight center line. If correction is necessary, loosen headlight mounting screws, adjust headlight, and retighten mounting screws.

Replacing headlight bulb and control bulb

Open headlight by unscrewing slotted screw and removing lamp insert.

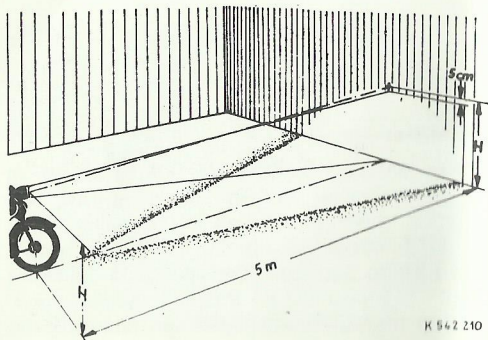

K 542 210



Separate plug connection (1) from bulb, remove clamps (2), and exchange headlight insert together with bulb.

Arrow 3: bulb for control light.

Replacing taillight, brake light bulb

Unscrew the two cross head screws and remove lens. Depress taillight, brake light bulb respectively approx. 2–3 mm, turn to the right or left and remove bulb from the carrier.

1 = brakelight bulb

2 = taillight bulb

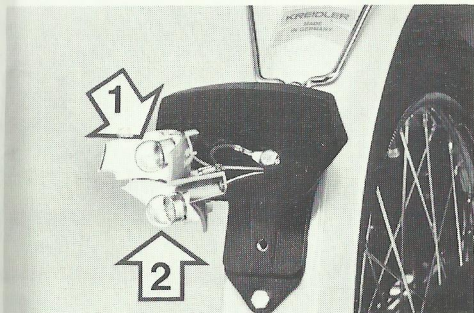
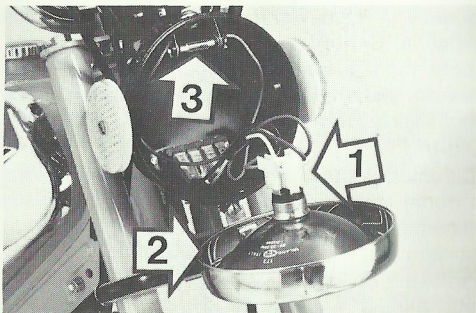

Replacing bulb of speedometer lighting

Turn speedometer housing top part so that the recess aligns with that in the bottom portion of the housing. Insert screw drivers into the thus created openings and lift the top portion. Remove bulb socket from speedometer and replace bulb.

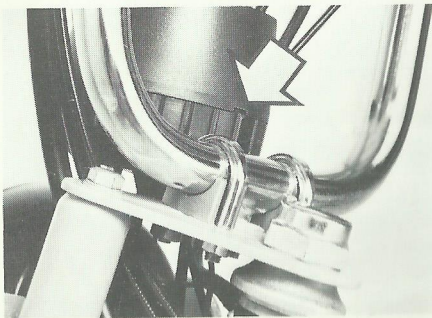

Vehicle cleaning

Beside the continuous control of the operational conditions also the regular attendance to the painted, chromed and plastic parts will save you from unpleasant surprises and unnecessary expenditures and ensure that your vehicle maintains its value for a long time.

Wash your KREIDLER Moped regularly since the dirt on the roads and pollution in the air, particularly in industrial areas, attack the surfaces of your vehicle. Use ample cold or lukewarm water and sponge; wash the sponge frequently in clear water to remove the dirt particles in it in order not to scratch the surfaces more than unavoidable. Soak hard dirt spots before washing. After washing apply occasionally a coat of commercially available polish.

Chromed parts may be protected by special chrome protective agents, which is particularly recommended at the beginning of the winter season and after the spring cleaning.

Do not use the above mentioned agents for the engine cowling (plastic). You can buy

special plastic cleaning agents, however, the usual plastic cleaners in your household will do as well.

Operation in wintertime

Preparing vehicle

ensure easy cold start conditions through correct sparkplug heat range, correct electrode gap, replacement of old sparkplug, and perfect setting of firing point — for details refer to section “ignition system” — adjust carburetor to winter operation as described under paragraph “carburetor”.

Reducing tire pressure

does not increase the friction between tire and road surface, however, it impairs the lateral tire guide — accordingly, adhere to the specified tire pressures also in wintertime, see “wheels and brakes”.

Tread depth

Mount tires having at least 2 mm tread depth although the law prescribes 1 mm minimum

tread depth — new tires have 3.5 — 4 mm tread depth.

Cables

disconnect cables of clutch and brake on handlebar and foot brake cable and pour light-bodied oil into the cable hoses, which prevents water from freezing inside and blocking the cables.

Road salt

is highly aggressive and attacks metal as well as varnish alike through corrosion — the best solution is to wash the vehicle immediately after arrival at destination protecting the dry vehicle with an anti-corrosive oil from a spray can is okay, but it constitutes no guarantee against the attack by salt.

Storage

Thoroughly clean the entire vehicle — apply anti-corrosive oil from a spray gun to all bright metal parts as a protection against rust —

painted components may be treated by a wax-containing polish (dull-black paint assumes a slight shine when polish is applied). Close fuel valve while engine is running and wait until the carburetor is empty; this prevents the gasoline in the carburetor from evaporating, while the non-evaporated oil remains in the carburetor and may block bores and jets. The gasoline supply in the tank may be left in it.

Unscrew sparkplug, fill 2-3 cc anti-corrosive oil (e.g. the additive Desolite for two stroke engines) through the plug bore; shift into second gear and rotate engine via the rear wheel so that the protective oil spreads over the internal engine surfaces.

Place vehicle on kick stand so that the weight is off of the tires. Under no circumstances must the air be taken out of the tires; do not store the vehicle for winter with "flat" tires.

Troubleshooting

Engine does not start

Fuel tank empty or fuel valve closed. Auxilliary

starting device for cold starting was not activated (depress pin).

Jets or fuel valve strainer clogged.

Electrode gap of sparkplug too wide or foreign matter between electrodes (bend to 0.4 mm gap or clean).

Failing ignition system.

For checking fit new sparkplug to plug connector, hold against ground and rotate engine while pulling the flying start clutch lever. If plug does not spark, the ignition system is faulty.

Possible causes for ignition failure: shielded plug connector is punctured by water — ignition cable defective — breaker points oily, dirty or scored — ground connection in short circuit switch.

If the engine does not start it might be possible that the float needle seat in the carburetor is dirty so that fuel can flow into the stopped engine if the fuel valve is not closed.

For starting, close fuel valve and apply "full throttle" while starting. If the engine still does not start, unscrew sparkplug and operate

engine via the pedals without compression by pulling the start clutch lever (may be done by hand). Then mount dry sparkplug and start.

Engine starts but dies soon after and does not respond to the throttle

Fuel valve is closed; engine runs only until float chamber is empty. Or engine is still cold so that the auxiliary starting device must be depressed once more (open throttle twist grip up to the perceptible stop).

Main jet in carburetor is clogged.

Engine runs in four stroke cycle and emits smoke through the muffler

Float needle sticks causing enrichment of the fuel mixture.

Float is bent causing incorrect level (see your KREIDLER dealer).

Air filter clogged.

Motor output decreases

Passages in the exhaust system are sooted (clean). Piston rings are sticking (see your

KREIDLER dealer). Throttle slide does not move up all the way (readjust set screw).
Air filter clogged.

Brakes drag against brake drum (return springs fail to retract brake shoes and bowden cables).

Rear wheel chain stiff or too tight.

Firing point is offset (see your KREIDLER dealer).

Idling speed is excessively high

Throttle slide sticks (disassemble carburetor, remove abrasives or foreign particle).

Repair bowden cable.

Slide stop screw screwed in too far.

Engine stalls in idling when headlight is turned on

Electrode gap of sparkplug too wide (bend to 0.4 mm).

Contact breaker offset.

Engine hesitates at idling speed

Idling speed is too high or too low. Check adjustment.

Technical data

Mo - Ped MP 9

Engine

| | |
|----------------------|--|
| Type | horizontally installed single cylinder two stroke engine |
| Bore stroke | 1.58 x 1.55 in. = 40 x 39.7 mm |
| Piston displacement | 3.045 cub. in = 49 cc |
| Continuous output * | 17 mph, 20 mph, 25 mph, 30 mph * |
| with rpm at approx. | 4,250 |
| Compression ratio | 10:1 |
| Cooling | air cooled |
| Cylinder with piston | aluminium hard chrome plated |
| Cylinder head nuts | torque 0.9–1.1 kpm ** = 6.5–7.9 foot-pounds |

Power transmission (gearbox)

| | |
|--------------|--|
| | 2-speed automatic |
| Oil capacity | 330 cc ($\frac{1}{3}$ quart) KREIDLER-Special-Automatiköl or Mobiloil ATF 210 resp. Ford Specification 2 P-630 822 (M 2 C – 33 F) |

* = depending on State law

** = kpm = kilopondmeter

| | |
|------------------------|--|
| Primary drive | 1st gear 1:7.67 2nd gear 1:23 |
| Final drive | 1st gear 1:4.83 2nd gear 1:14.5 |
| Drive chain | 1/2" x 3/16", 102 links including connecting link |
| Front sprocket | 12 teeth |
| Rear sprocket * | 36 teeth |
| Ignition system | |
| Type | BOSCH fly wheel magneto |
| Capacity | 6 V 27/10 W (SAE N 70) |
| Firing point | 1.2–1.4 mm before top dead center (TDC) = 18–19° crank angle |
| Sparkplug | Bosch W 175 T 1, Beru 175/4, Champion L 86 |
| Electrode gap | 0.4 mm to 0.5 mm |
| Carburetor | |
| Type * | Bing 1/12/260 (1 barrel, 12 mm ϕ) |
| Main jet * | 68 * |

* = depending on State law

| | |
|---------------------------|---|
| Needle jet seat | size 2.17 |
| Needle jet | size 46-042 altitude setting No. 2 |
| Throttle slide | size 22-140-10 |
| Fuel | |
| Tank capacity | 5.6 ltrs. (1.055 US gal.), including 0.6 ltr. reserve |
| Lubrication | 50:1 (2%) gasoline/oil mixture |
| Oil | self-mixing two stroke oil or HD oil SAE 40 or SAE 50 |
| Fuel consumption | approx. 1.7 ltr./100 km = 150 m.p.g. |
| Chassis | |
| Frame | steel tubular frame |
| Suspension front | teleskopic |
| Suspension rear | swinging arm with shock absorber |
| Wheels and brakes | |
| Wheels | Chromium-plated steel with spokes |
| Rims, front and rear | size 1.20 x 17 |
| Tire, front and rear | size 2.25 x 17 |
| Tire pressure, front/rear | 1.6/2.5 atmospheres = 22.7/35.5 psi |

| | |
|------------------------------|---------------------------------------|
| Brakes, front and rear | 31.5 in. drum diameter, hand operated |
| Brake linings front and rear | glued, min. lining thickness 2 mm |
| Brake lining area | front and rear total 12 sq.in. |

Electrical system

| | |
|----------------------------|-------------------------|
| Headlight | 6 V 20/20 W sealed beam |
| Taillight | 6 V 5 W |
| Brakelight | 6 V 10 W |
| Speedometer light | 6 V 0.6 W |
| Hi-Lo beam indicator light | 6 V 1.5 W |
| Horn | 6 V 18 W |

Dimensions and weight

| | |
|------------------------|--|
| Overall length | approx. 1,730 mm (68–69.5 in.) |
| Width | approx. 610 mm (24.1 in.) |
| Height (unloaded) | approx. 1,010 mm (3.976 in.) |
| Seat height (unloaded) | approx. 800 mm (31.49 in.) adjustable |
| Wheel base | approx. 1,135 mm (44–46 in.) |
| Weight | approx. 49 kg (110 lbs.), gasoline incl. |

Wiring diagram

1. Headlight bulb 6 V 20/20 W
3. Speedometer bulb J 6 V 0.6 W
5. Horn
7. a) Light switch
7. b) Dimmer
7. c) Horn button-handlebar switch
9. Ignition coil
10. Sparkplug
13. a) Brake light switch left and right
13. b) Brake light switch left and right
17. Magneto generator
19. Composite tail-brake-license plate light
bulb for brake light: G 6 V 10 W
bulb for taillight: G 6 V 5 W
21. Short circuit switch

blau = blue
 rot = red
 schwarz = black
 weiß = white
 grau = grey
 braun = brown
 gelb = yellow
 grün = green
 grün/rot = green/red
 grau/rot = grey/red

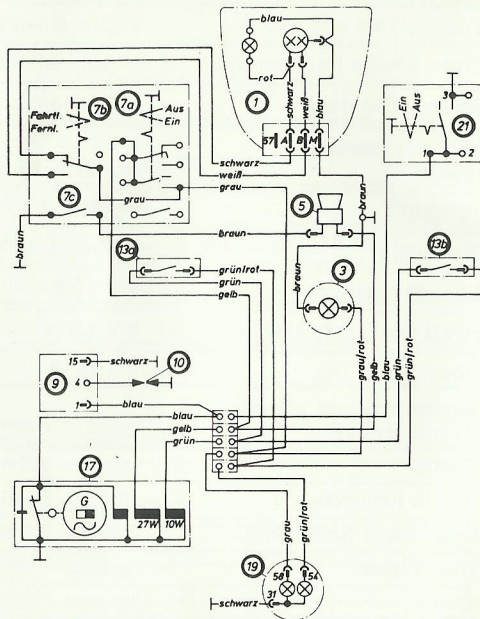



**KREIDLER WERKE GMBH
FAHRZEUGWERKE
D-7014 KORNWESTHEIM**

KF 1463 9.77